



RAMBOLL

Crossrail Archaeology Framework

C254 – Archaeology West

Non-listed Built Heritage Recording at Old Oak Common, Acton

Event Code XSU10

CRL Document Number: C254-OXF-T1-RGN-CRG05-50001rev2

Contract MDL reference CXX.XXX

1. Contractor Document Submittal History:

Revision:	Date:	Prepared by:	Checked by:	Approved by:	Reason for Issue:
2.0	15-04-16	[Redacted]	[Redacted]	[Redacted]	Acceptance
		DD [Redacted]	[Redacted]	[Redacted]	
1.0	09-07-15	[Redacted]	[Redacted]	[Redacted]	

2a. Stakeholder Review Required? YES NO

Stakeholder-submission-required: LU RfL Purpose of submission: For no-objection
 NR LO For information
 DLR Other: _____

This document has been reviewed by the following individual for coordination, compliance, integration and acceptance and is acceptable for transmission to the above stakeholder for the above stated purpose:

 Sign: _____ Role: _____ Name: _____ Date: _____

 Sign: _____ Role: _____ Name: _____ Date: _____

2b. Review by Stakeholder (if required):

Stakeholder Organisation	Job Title	Name	Signature	Date	Acceptance
					<input type="checkbox"/>
					<input type="checkbox"/>
					<input type="checkbox"/>

3. Acceptance by Crossrail:

		Crossrail Review and Acceptance Decal	
This decal is to be used for submitted documents requiring acceptance by Crossrail.			
<input checked="" type="checkbox"/>	Code 1.	Accepted. Work May Proceed	
<input type="checkbox"/>	Code 2.	Not Accepted. Revise and resubmit. Work may proceed subject to incorporation of changes indicated	
<input type="checkbox"/>	Code 3.	Not Accepted. Revise and resubmit. Work may not proceed	
<input type="checkbox"/>	Code 4.	Received for information only. Receipt is confirmed	
R [Redacted]	(Signature)	Print Name: [Redacted]	Position: [Redacted]
Accepted on behalf of Crossrail		Date:	28/4/16
Acceptance of this document is given in accordance with the designer's contractual obligations and does not constitute Crossrail approval of design, details, calculations, analyses, test methods or materials developed or selected by the designer/supplier.			



CONTENTS

	Page
1. INTRODUCTION.....	8
1.1 Background and scope of work	8
1.2 Site Description.....	8
1.3 Aims and objectives	9
2. METHODOLOGY.....	9
2.2 Level 3 recording	9
2.3 Level 2 recording	10
2.4 Level 1 recording	11
3. HISTORICAL BACKGROUND.....	12
4. THE SIGNIFICANCE OF THE SITE'S BUILDINGS AND STRUCTURES.....	15
5. STRUCTURE 15A: THE 'FACTORY' (LIFTING SHOP OR MAINTENANCE SHED).....	17
5.1 Introduction and summary	17
5.2 Outline History and map evidence.....	17
5.3 Description	18
6. STRUCTURE 15B: LIFTING BAY (PREVIOUSLY THE SMITHS SHOP)	28
6.1 Introduction and summary	28
6.2 Outline History and map evidence.....	28
6.3 Description	29
7. STRUCTURE 15C: BOILER HOUSE, COMPRESSOR HOUSE, LUBRICATION AND WASTE OIL TANKS, PREVIOUSLY THE COPPERSMITH'S SHOP AND CARPENTER'S SHOP	33
7.1 Introduction and summary	33
7.2 Outline History and map evidence.....	33
7.3 Description	34
8. STRUCTURE 16: THE STORES.....	38
8.1 Introduction and summary	38
8.2 History and map evidence	38
8.3 Description	39
9. STRUCTURE 17A: OFFICE & AMENITY BUILDING, PREVIOUSLY THE CANTEEN	49



9.1	Introduction and summary	49
9.2	History and map evidence	49
9.3	Description	49
10.	STRUCTURE 20: WORKSHOP, PREVIOUSLY THE MESS ROOM AND SAND FURNACE	57
10.1	Introduction and summary	57
10.2	History and map evidence	57
10.3	Description	58
11.	STRUCTURE 26: ELECTRICITY SUBSTATION B2.....	63
11.1	Introduction and summary	63
11.2	History and map evidence	63
11.3	Description	63
12.	STRUCTURE 39: THE MESS ROOM	65
12.1	Location and summary.....	65
12.2	History and map evidence	65
12.3	Description	65
13.	STRUCTURES 6 AND 53: HEAVY OIL FUELLING DEPOT (DIESEL/OIL) PUMPHOUSE, BUNDED WASTE OIL AND DIESEL OIL TANKS.....	67
13.1	Introduction and summary	67
13.2	Historical background and map evidence.....	67
13.3	Description	68
14.	STRUCTURE 1: SHUNTERS CABIN	72
14.1	Introduction and summary	72
14.2	History and map evidence.	72
14.3	Description	72
15.	STRUCTURE 22: PULLMAN SHED (FORMERLY THE CARRIAGE SHED, PAINTSHOP AND THE ELECTRICAL SHOP,).....	74
15.1	Introduction and summary	74
15.2	Outline history and map evidence	74
15.3	Description	74
16.	STRUCTURE 23: LIFTING SHOP (FORMERLY THE CARRIAGE LIFTING SHED).....	81
16.1	Introduction and summary	81
16.2	Outline history and map evidence	81
16.3	Description	81
17.	STRUCTURE 24: SUMP/OIL INTERCEPTOR	85



18.	STRUCTURE 36: SUB-STATION B3 (BRICK-BUILT ELEMENT,)	86
19.	STRUCTURE 3: CARRIAGE WASHING PLANT	87
20.	STRUCTURE 4: UNDERFRAME CLEANING SHED	88
21.	STRUCTURE 5: STEAM-RAISING PLANT	90
22.	STRUCTURE 7: CARRIAGE WASHER TREATMENT PLANT	91
23.	STRUCTURE 8: WATER TOWER	92
24.	STRUCTURE 9-10: TEMPORARY METAL STORE	93
25.	STRUCTURE 12: WATER SOFTENING PLANT	94
26.	STRUCTURE 13: WATER TOWER (SOFT WATER)	96
27.	STRUCTURE 17B: NEW AMENITY BUILDING	97
28.	STRUCTURES 11 AND 18: OFFICES	99
29.	STRUCTURE 19: DIESEL REFUELLING MAINTENANCE SHED	100
30.	STRUCTURE 21: BOILER HOUSE FOR PULLMAN SHED AND LIFTING SHOP	103
31.	STRUCTURE 30: TOILET BLOCK/OFFICE/MESS ROOM	105
32.	STRUCTURE 36: SUBSTATION B3, PREFABRICATED ELEMENT	106
33.	STRUCTURE 38A: SUBSTATION B5	107
34.	STRUCTURE 52: BUNDED WASTE OIL TANK	108
35.	STRUCTURES 34 AND 54: OIL TANKS AND PUMPHOUSE	109
36.	SALVAGE ITEMS AND OUTSTANDING ITEMS	110
	36.1 Salvage items	110
	36.2 Outstanding project requirements.....	110
37.	DISCUSSIONS AND CONCLUSION	112
	APPENDIX 1 BIBLIOGRAPHY AND REFERENCES	115
	APPENDIX 2 SUMMARY OF SITE DETAILS AND OASIS REPORT	115
	APPENDIX 3 LASER SCAN AND DIGITALSURVEY FILES	116

General Figures

Figure 1: Site location

Figure 2: Site plan

Figure 3: Combined plan showing buildings covered by laser scan

Figure 4: Isometric slice of Building 15 from laser scan

Figure 5: Isometric slice of Building 16 from laser scan

Figure 6: Plan of primary site re-drawn in 1950s. (Ref: 2515-409-1516)

Figure 7: 1906 plan (ref: 2515-410-0062)

Figure 8: 1930 plan (ref: 2515-403-2178)



- Figure 9: 1938 plan (ref: 2515-403-2183)
- Figure 10: 1943 plan (ref: 2515-410-0672)
- Figure 11: 1949 plan (ref: 2175-403-2193)
- Figure 12: 1958 plan (ref: 2515-403-2195)
- Figure 13: 1966 plan (ref: 2515-410-2172)
- Figure 14: 1903 detail of engine shed roof (ref: 2515-409-0692)

There are also individual figures included separately for some of the buildings.



Summary

During 2010 and 2011, Oxford Archaeology, in partnership with Ramboll (OA Ramboll, Crossrail contract C254) undertook a programme of non-listed built heritage recording (NLBH) at Old Oak Common Train Maintenance Depot in Acton, London, on behalf of Crossrail. The work took place in advance of a major redevelopment of the site which required the demolition of most of its buildings. The recording provides additional information to a Detailed Desk-based Assessment of the site (Non-Listed Built Heritage) undertaken by Pre-Construct Archaeology (PCA).

The locomotive depot was constructed by the Great Western Railway (GWR) in 1904-6 under the stewardship of the company's Locomotive, Carriage and Wagon Superintendent George Jackson Churchward. The depot formed a template for a new generation of GWR depots across their empire. A major change occurred in the 1960s as a result of the 1955 Modernisation Plan. This plan was issued by the British Transport Commission, the body who ran the railways on behalf of the Government, who had been the owner of most of the nation's railways since 1948. Early moves towards diesel powered locomotives accelerated as the 1950s drew to a close and on 27 March 1965 Old Oak Common closed to steam locomotives. By then major parts of Churchward's depot has been torn down to make way for new buildings. The depot continued to service and maintain a wide range of diesel locomotives and rolling stock up to its closure in 2009.

The NLBH recording at Old Oak Common recorded c.34 buildings or features, and was undertaken to the guidelines defined by English Heritage in '*Understanding Historic Buildings*'. The eleven most historically significant buildings, which were recorded to English Heritage Level 3, included the surviving primary structures from depot's inception, principally the Stores, the 'Factory', the Sand Furnace and the Substation. These were buildings assessed in the PCA Desk-based Assessment as being of at least regional significance. Level 3 recording also covered a small number of significant secondary structures related to experiments and trials of refuelling with oil. The recording of each of these structures comprised the production of detailed drawings, photographs and analytical descriptions, as well as an internal and external laser scan of select structures.

Five structures of a lower significance (assessed by PCA as being of local significance) were recorded to English Heritage Level 2. These included the Pullman Shed and the Carriage Lifting Shop, both of which were constructed in the late 1930s. The recording of these included the production of drawings, photographs and descriptions, as well as a laser scan of the exterior of the buildings.

Eighteen buildings or structures of low significance, such as modern additions, water towers and Portacabins were recorded to English Heritage Level 1. The recording of these was based largely on photography and written descriptions related to an overall site plan.

The works reported here also included assessment of items which might be considered for salvage because of their historic interest, and subsequent guidance on how these might be salvaged for reuse. The salvage items were managed by Crossrail and documented in report C160-XRL-T1-GPD-CRG03-50001.



Non-listed Built Heritage Recording at Old Oak Common, Acton Event Code XSU10
C254-OXF-T1-RGN-CRG05-50001rev2

The recording and the production of this report were greatly assisted by a number of historic archive drawings and photographs as well as by PCA's Detailed Desk-based Assessment of the site.



1. INTRODUCTION

1.1 Background and scope of work

- 1.1.1 This report presents the results of non-listed built heritage recording (NLBH) undertaken in advance of demolition works by Crossrail Ltd at Old Oak Common Train Maintenance Depot (OOC TMD), a major rail facility located within the London Borough of Hammersmith and Fulham at TQ 21870 82390. The work was undertaken by Oxford Archaeology, in partnership with Ramboll (OA Ramboll) under Crossrail contract C254. The main site recording was undertaken between November 2010 and March 2011, with further work following in May and October 2011. The recording built on a previous Detailed Desk-based Assessment of the site (Non-listed Built Heritage Recording) undertaken by Pre Construct Archaeology (PCA).
- 1.1.2 The NLBH followed the methods set out in an *Archaeology Method Statement* for the site (document number C254-OXF-W-GMS-CRG03-00004 Rev 4.0) and a requirement for works set out in *Old Oak Common Worksites Site Specific Archaeological Written Scheme of Investigation (SSWSI)* (document number CR-EG-00C-EN-SP-00001 Rev 3.0). In addition, it followed the recommendations outlined in a detailed desk-based assessment (DDBA, C150-CSY-T1-RGN-CR076_PT001-00011 Rev 4.0) which outlined the survival and importance of the built heritage at the site, and provided recommendations on the level of recording for each that should be undertaken prior to demolition. It also identified structures that no longer survived, and provided a history of the development of the site. All known structures, past and present, are shown on Figure 1.
- 1.1.3 This report supersedes an Interim Statement of the NLBH work (C254-OXF-T1-RGN-CRG03-50039 Rev 2.0).
- 1.1.4 Separate below-ground investigations have also been undertaken at Old Oak Common as part of the Crossrail development but these will be reported on separately.

1.2 Site Description

- 1.2.1 Old Oak Common is an area of West London between Willesden and Acton. It contains an extensive railway site under the control of several different train operating companies. The part of OOC TMD adopted by Crossrail comprised stabling sidings, engine sheds, workshops and other related railway facilities. The surrounding area is dominated by industrial and warehousing estates and road, rail and canal transport systems. Small pockets of residential development are located to the west along Shaftesbury Gardens and Wells House Road, and to the south of Wormwood Scrubs Park.



- 1.2.2 Crossrail required OOC TMD to be remodelled, initially to support the manufacture and storage of pre-cast concrete segments for the central (tunnelled) section of the Crossrail route and the work reported here was undertaken in advance of demolition to enable this use to commence. This temporary use ended in 2014 and at the time of writing has been superseded by construction work to convert the site into maintenance and stabling facilities for Bombardier, who will build and maintain Crossrail's rolling stock.
- 1.2.3 The site is bounded by Old Oak Common Lane to the west, the Grand Union Canal to the north, and the First Great Western TOC Depot and marshalling sidings to the south. The land is triangular in shape, narrowing towards the east and throat of the depot. The site level has been significantly reduced through historic terracing works associated with the railway.

1.3 Aims and objectives

- 1.3.1 The overall aim of the NLBH was to produce an archive record of buildings and structures at OOC TMD.
- 1.3.2 Particular objectives of the project were to:
- Record the overall form of the complex prior to demolition;
 - Record evidence of the development and former use of the buildings;
 - Enhance understanding of the history and evolution of the site;
 - Record evidence relating to the primary use of the buildings;
 - Record evidence related to the conversion of the complex to diesel; and
 - Assist with a programme of artefact salvage.

2. METHODOLOGY

- 2.1.1 The NLBH followed the recommendations set out in the DDBA (C150-CSY-T1-RGN-CR076_PT001-00011 Rev 4.0) undertaken in 2010 by PCA. The DDBA assessed the significance of each structure on the site and, based on this assessment, provided a recommendation for the appropriate level to which it should be recorded. The levels of recording followed English Heritage guidelines (as defined in *Understanding Historic Buildings: a Guide to Good Recording Practice*) and ranged from Level 3, for the most significant structures, to recommendations that no recording was necessary (for the least significant structures).
- 2.1.2 The DDBA also developed a gazetteer of the site's structures and buildings (both extant buildings and former structures), which resulted in such items being numerically numbered (see Fig.2). The current report uses these identifying numbers throughout (eg Structure 19. Diesel Refuelling Maintenance Shed). The list of all the buildings and structures at the site is included below at Section 2.

2.2 Level 3 recording



2.2.1 The structures recorded to an English Heritage Level 3 standard were principally those which survived from the original 1906 layout (or which were added in the very early years) and comprised:

- the 'Factory' (the Lifting Shop or Maintenance Shed, Structure 15a);
- the Lifting Bay (previously the Smiths shop, Structure 15b);
- the Boiler House, Compressor House, Lubrication and Waste Oil Tanks, previously the Coppersmith's Shop and Carpenter's Shop (Structure 15c)
- the Stores (Structure 16a);
- the Store Offices (Structure 16b);
- the Amenity Building, previously the Canteen (Structure 17a);
- Workshop, previously the Mess Room and Sand Furnace (Structure 20);
- the Electricity Substation B2 (Structure 26); and
- the Mess Room (Structure 39)

2.2.2 In addition, the former locomotive oil fuelling depot/gas turbine locomotive fuelling depot structures, which were secondary additions but which had been previously assessed as being of comparable significance, were also recorded to a Level 3 standard. These were the heavy oil fuelling depot (Diesel/oil Pumphouse, Bunded Waste Oil and Diesel Oil Tanks, Structures 6 and 53);

2.2.3 The final structure to be assessed as of regional significance was the 70' turntable (Structure 28). This was recorded by PCA before OA Ramboll were appointed to undertake the NLBH at the site, the full results of the NLBH exercise being provided in document (C150-CSY-T1-RGN-CR076_PT001-00019 Rev 2).

2.2.4 Typically the Level 3 recording included producing:

- drawn floor plans;
- drawn elevations and/or sections;
- further drawings such as structural details;
- photographs of external and internal features; and
- an analytical description.

2.3 Level 2 recording

2.3.1 The DDBA recommended that surviving structures from the period between the 1930s and the early 1950s which were assessed as being of regional significance (or in the case of Structure 1 local significance) should be recorded to a Level 2 standard. These comprised the:

- the Shunters Cabin (Structure 1);
- the Pullman Shed (formerly the Carriage Shed, Paintshop and the Electrical Shop, Structure 22);
- the Lifting Shop (formerly the carriage lifting shed, Structure 23)
- the Sump Oil Interceptor (Structure 24);
- the 70' turntable (Structure 28); and
- Sub-station B3 (brick-built element, Structure 36a)



2.3.2 The Level 2 recording generally included producing:

- ground floor plans
- photographs of external and internal features; and
- an analytical description.

2.4 Level 1 recording

2.4.1 The DDBA recommended that eighteen structures, largely dating from the conversion of the steam locomotive depot to a diesel MPD in the mid-1960s, and assessed to be of local or negligible significance, be recorded to an English Heritage Level 1 standard. These were the:

- the Carriage Washing Plant (Structure 3);
- the Underframe Cleaning Shed (Structure 4);
- the Steam-raising Plant (Structure 5);
- the Carriage Washer Treatment Plant (Structure 7);
- the Water Tower (Structure 8);
- the Temporary Metal Store (Structure 9);
- the Offices (Structure 11);
- the Water Softening Plant (Structure 12);
- the Water Tower (soft water) (Structure 13);
- the New Amenity Building (Structure 17b);
- the Offices (Structure 18);
- the Diesel Refuelling Maintenance Shed (Structure 19);
- the Toilet Block/Office/Mess Room (Structure 30);
- the Fuel and Heating Oil Tanks (Structure 34);
- the Substation B3, prefabricated element (Structure 36a);
- the Substation B5 (Structure 38a);
- the Bunded Waste Oil Tank (Structure 52); and
- the Diesel Oil Tank Pumphouse (Structure 54)



2.4.2 The Level 1 recording generally included producing;

- photographs of external and internal features; and
- an analytical description.

2.4.3 Prior to the works described here there was no modern metric survey of the site available, other than a topographical layout drawing produced by Capita Symonds (dwg CS-038089-GEO-STA-SK-0004-P5, see Fig.1). For this reason, at the start of the NLBH works, the complex was laser-scanned by APR Services on behalf of OA/Ramboll to provide such a baseline (see Figs 4 and 5 for examples). Line drawings were then produced in AutoCAD from the laser scan to fulfill the requirements of the English Heritage guidelines.

2.4.4 The current report comprises:

- a general introductory section looking at the overall background, significance, history of the site,
- a number of general plans of the site
- A gazetteer where the description of each individual building is followed by a number of plates of that building and also a number of figures, (for the buildings recorded at the higher level). An individual numbering system for the plates has been used for each building so for example the plates for Building 20 are numbered 20.1, 20.2, 20.3 etc.

3. HISTORICAL BACKGROUND

3.1.1 The historical background to the OOC TMD has been covered in detail in the DDBA. The section below provides a short summary of information drawn from that document and from subsequent research undertaken by OA Ramboll in the course of publishing the results of Crossrail's recording of historic railway assets.

3.1.2 The site and its surrounding area remained woodland until the beginning of the post-medieval period, after which it became increasingly used for common grazing. Local residents had pasture rights on this land and received compensation at the time that the Grand Union Canal was developed at the very end of the 1700s, and again in 1837 when the GWR started to develop the area. The GWR was only the first of numerous railway companies to eventually construct lines in the area, so that in time the locality began increasingly to take on the appearance of a railway town.

3.1.3 The site first fell within this railway orbit when it was partially excavated in c.1900 in association with the construction of the Acton to Northolt line. But the die had been cast for the site two years previously when the GWR board, anxious to alleviate the congestion and inefficiencies of the Paddington to Westbourne Park corridor, alighted on the possibility of developing it into a goods yard and coal depot stage, with the capacity also to house carriage and undertake marshalling activities.

3.1.4 This scheme was substantially revised the following year (1899) in order that it could also accommodate the engine works that needed replacement at Westbourne Park. Work on developing the site initially progressed slowly, but by 1903, with the GWR's new Locomotive Superintendent George Jackson Churchward in post, a tender had



been awarded to a Derby-based company to construct 'the offices, lifting shop, stores, carpenters', smiths' and coppersmiths' shops, sand furnaces (collectively known in Great Western parlance as the 'Factory'), the engine shed, WCs, messrooms, internal and external inspection pits, turntable foundations and a coal stage and elevated road thereto'.

- 3.1.5 Construction of one of the most up-to-date locomotive repair facilities in the country began in 1904 and was completed two years later (the depot opened on 17 March 1906). A combination of tried-and- tested construction techniques and modern materials was used to create a depot capable of accommodating and servicing the company's latest and largest locomotives. Churchward took advantage of readily available electrical power and procured a range of the latest electrically-operated machinery for the new depot.
- 3.1.6 As the first of a number of new locomotive depots built by the GWR during the Churchward era, the layout of Old Oak Common served as the template for those that followed, the majority of which were closed and demolished in the late 1960s. In contrast, Old Oak Common was retained and converted into a motive power depot (MPD) for diesel locomotives in the mid-1960s. Despite the demolition of much of the Engine Shed, a substantial amount of Churchward's depot survived and continued to flourish into the diesel era. Until its recent demolition Old Oak Common represented the last remaining 'factory' repair facility on the former Great Western Railway network.
- 3.1.7 From its opening, modifications and repairs were undertaken, and the DDBA outlines some of these in detail. A more substantive development occurred in 1927 when the GWR commissioned a refuse incinerator on ground a short distance to the north-east of the boiler washing plant. This was designed to burn waste in a coal-fired furnace which heated a boiler, the steam from which drove two new compound duplex pumps installed in the boiler house. In turn these pumps circulated the hot water for the washing and filling tanks in the boiler washing plant, replacing the existing boilers. The waste was brought into the destructor building by wagons using an existing siding, while smoke was expelled by a brick chimney built at the south-west corner of the building.
- 3.1.8 In the later 1930s a government-backed scheme to relieve mass unemployment led to an expansion of Old Oak Common. This saw the construction of a new carriage lifting shop and carriage paint shop (Structures 22 and 23) which were formally opened in April 1940. The intervention of WWII diverted any new development on the site into measures to protect the GWR's infrastructure and its staff. A series of air-raid shelters and ash shelters (to shield the glow of embers from passing aircraft) were constructed and anti-aircraft weaponry installed. Despite these defences the site was attacked several times.
- 3.1.9 In 1946 the GWR built a heavy oil fuel depot (Structures 6 and 53) in order to refuel coal-fired locomotives converted to run on oil, and set about replacing the four existing turntables at the site. The most intriguing development of the immediate post-war period was, however, the development at the end of the decade (by the now nationalised British Railways) of a fuelling plant for the network's experimental gas-turbine electric locomotives, only two of which were ever to operate on the national railway network. Although the experiment was a failure the infrastructure installed to



fuel the locomotives was put to use to service the new diesel locomotives that started to appear on the nation's networks.

- 3.1.10 The British Transport Commission's Modernisation Plan of 1955 ushered in a transformation of the site into a diesel maintenance unit. The first development of this era was the conversion of the carriage paint shop (Structure 22) into a maintenance depot for British Railway's new Pullman DMUs (Diesel Multiple Unit) which entered service between Paddington and Bristol in 1960. The gradual introduction of further locomotives, including the iconic Warship and Western lines, rendered whole areas of the existing depot, such as the coal stage, redundant, while the new diesel servicing regime meant that extensive covered accommodation at the engine shed was also surplus to requirements.
- 3.1.11 The transition from steam to diesel was completed in 1965, although the demolition of the engine shed began in March 1964. Servicing of the new fleet took place at a new servicing shed, a new sand drying house being added to the north elevation. Thereafter, the depot continued in use with only lightweight structures being added as demand arose. The site finally closed in 2009.



4. THE SIGNIFICANCE OF THE SITE'S BUILDINGS AND STRUCTURES

4.1.1 As outlined above a Desk-based assessment of Old Oak Common was undertaken by PCA which provided a detailed historical background on Old Oak Common. The DDBA also developed a list of all the site's structures and buildings (both extant buildings and former structures). The list also included an assessment of the historic significance of the extant buildings or structures (but generally not of the former features). The full list of gazetteer entries and the adjudged significance of each (where given) is provided in the table below

Table 1: List of buildings and structures at Old Oak Common from PCA DDBA (including sites of former structures)

Structure number	Description	Significance
1.	Shunter's cabin	Local
2.	Network Rail Cabin Maintenance	Not given
3.	Carriage Washing Plant (Bombardier)	Negligible
4.	Underframe Cleaning Shed	Local
5.	Steam Raising	Local
6.	Diesel/Oil Pumphouse	Regional to National
7.	Carriage Washer Treatment Plant	Negligible
8.	Water Tower	Negligible
9.	Temporary Metal Store	Negligible
10.	Safety Store	Not given
11.	Offices	Negligible
12.	Water Softening Plant	Local
13.	Water Tower (Soft Water)	Local
14.	Open Sided Store	Not given
15a.	The Factory Aka Lifting Shop Or Maintenance Shed	Regional
15b.	Lifting Bay Previously Smiths Shop	Regional
15c.	Boiler House, Compressor House, Lubrication & Waste Oil Tanks (Previously Coppersmiths Shop And Carpenters Shop)	Regional
16a.	Stores	Regional
16b.	Stores/Offices	Regional
17a.	Amenity Building, Previously Canteen	Regional
17b.	New Amenity Building	Regional
18.	Offices	Negligible
19.	Diesel Refuelling Maintenance Shed	Local
20.	Workshop Previously Mess Room And Sand Furnace	Regional
21.	Boiler House For Pullman Shed And Lifting Shop	Negligible
22.	Pullman Shed Aka Carriage Shed, Carriage Paintshop, Electrical Shop	Regional
23.	Lifting Shop Aka Carriage Lifting Shed	Regional
24.	Sump/Oil Interceptor	Regional
25.	Access Road	Not given
26.	Sub Station B2	Regional
27.	Outline Of Demolished Steam Shed	Not given
28.	Turntable	Regional



Non-listed Built Heritage Recording at Old Oak Common, Acton Event Code XSU10
C254-OXF-T1-RGN-CRG05-50001rev2

29.	Bunded Oil Tank	Not given
30.	Toilet Block/Office/Mess Room	Negligible
31.	Diesel/Oil Overhead Delivery Line	Not given
32.	Diesel/Oil Delivery Area	Not given
33.	Site Of Demolished Ash Shelters	Not given
34.	Fuel And Heating Oil Tanks	Negligible
35.	Site Of Demolished Masonry Arches To Support Raised Tracks	Not given
36a.	Sub Station B3	Local
36b.	Sub Station B7	Not given
37.	Site Of Demolished Boiler House	Not given
38a.	Substation B5	Negligible
38b.	Southern And South East Incoming Supply	Negligible
39.	Mess Room	Regional
40.	Coronation Sidings	Not given
41.	Buried Turntable Pits	Not given
42.	Buried/Site Of Traverser Pit	Not given
43.	Site Of Demolished Water Softener	Not given
44.	Site Of Demolished Refuse Destructor/Incinerator	Not given
45.	Site Of Demolished Sand Furnace	Not given
46.	Site Of Demolished Mess Rooms, Toilets And Stores	Not given
47.	Site Of Demolished Coaling Stage And Water Tower	Not given
48.	Site Of Demolished Embankment Leading To Coaling Stage	Not given
49.	Conservation Area Formerly Coal Stock Pile	Not given
50.	Tank Bases To Previously Removed Oil Tanks	Not given
51.	Site Of Embankment Leading To Former Boiler House	Not given
52.	Bunded Waste Oil Tank	Regional
53a.	Bunded Diesel/Oil Tank	Regional to National
53b.	Site Of Demolished Diesel/Oil Tank	Regional to National
54.	Diesel/Oil Tank Pump House	Negligible
55.	Covered Walkway To Rear Of Stores	Not given
56.	Covered Walkway	Not given
57.	Gas Meter House	Not given
58.	Water Meter House	Not given
59.	Pipe Bridge	Not given
60.	Site Of Demolished Air Raid Shelters	Not given
61.	Site Of Demolished Oil Tank	Not given
62.	Retaining Wall	Not given
63.	Railwayman's Hostel (Derelict)	Not given
64.	Site Of Demolished Boiler Washing Plant	Not given
65.	Site Of Demolished Pump House	Not given
66.	Site Of Demolished Proportion Gear House	Not given
67.	North Boundary Retaining Wall	Not given

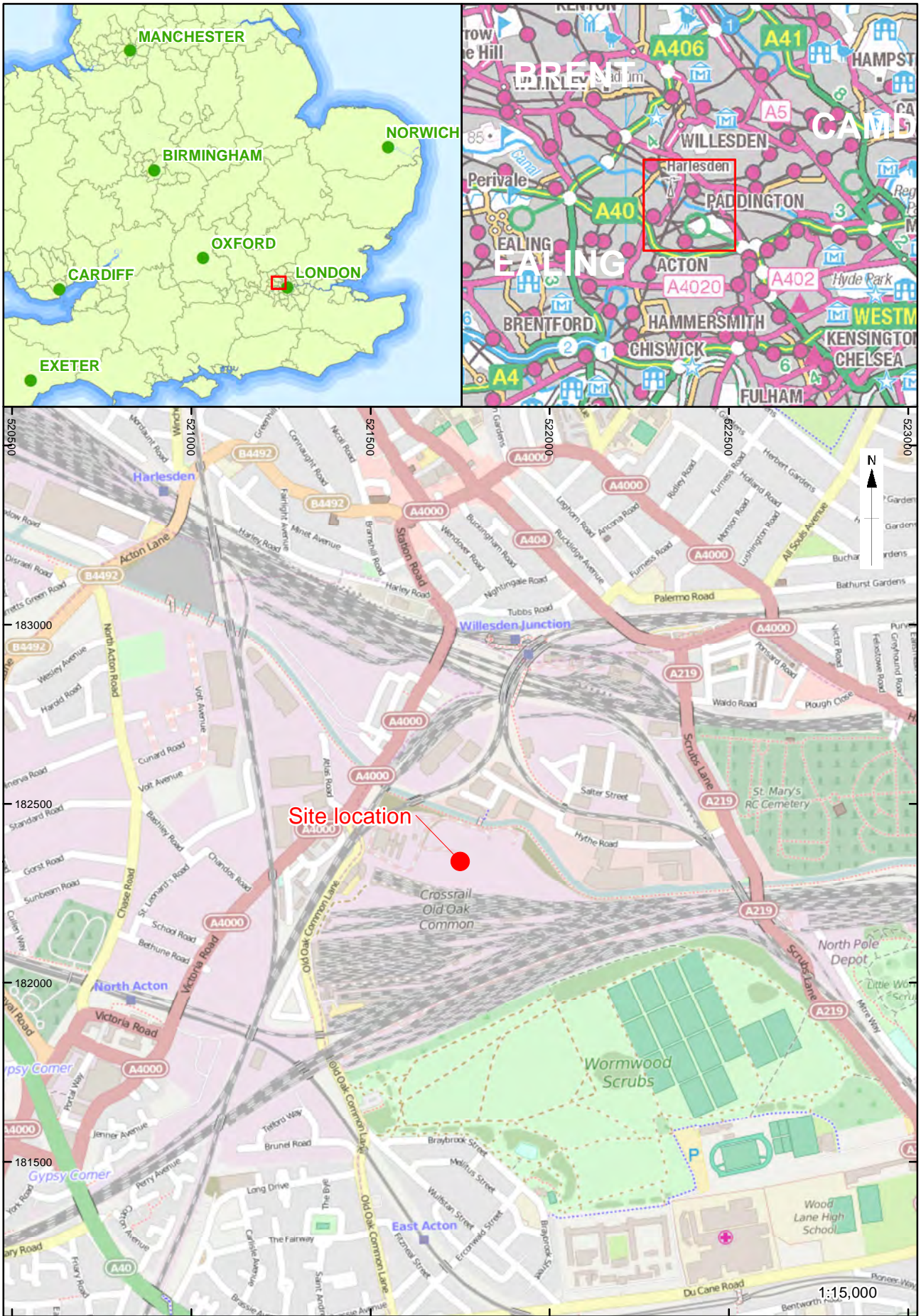

C:\Users\markus.dylewski\OneDrive\XFRALM_OOCBR\Fig_01.mxd*markus.dylewski* 18/06/2015

Contains Ordnance Survey data © Crown copyright and database right 2014
 (c) OpenStreetMap and contributors, Creative Commons-Share Alike License (CC-BY-SA)

Figure 1: Site location

Reproduced from drawings supplied by Capita Symonds (April 2010)
Amended by PCA July 2010
Amended by OAG Dec 2010

NOTES

- 1. SHUNTERS CABIN
- 2. NETWORK RAIL CABIN MAINTENANCE
- 3. CARRIAGE WASHING PLANT (BOMBARDIER)
- 4. UNDERFRAME CLEANING SHED
- 5. STEAM RAISING PLANT
- 6. DIESEL/OIL PUMPHOUSE
- 7. CARRIAGE WASHER TREATMENT PLANT
- 8. WATER TOWER
- 9. TEMPORARY METAL STORE
- 10. SAFETY STORE
- 11. OFFICES/PORTA CABINS
- 12. WATER SOFTENING PLANT
- 13. WATER TOWER (SOFT WATER)
- 14. SUMP/OIL INTERCEPTOR
- 15a. THE FACTORY AKA LIFTING SHOP OR MAINTENANCE SHED
- 15b. LIFTING BAY AKA THE FACTORY OR COPPERSMITHS SHOP
- 15c. BOILER HOUSE - FACTORY INC. TANKS
- 16a. STORES
- 16b. STORES/OFFICES
- 17a. AMENITY BUILDING PREVIOUSLY CANTEEN. DATES 1908
- 17b. NEW AMENITY BUILDING
- 18. OFFICES/PORTA CABINS
- 19. DIESEL REFUELING MAINTENANCE SHED
- 20. MESS ROOM PREVIOUSLY SAND FURNACE
- 21. BOILER HOUSE - PULLMAN SHED
- 22. PULLMAN SHED AKA CARRIAGE SHED. CARRIAGE PAINTSHOP. ELECTRICAL SHOP
- 23. LIFTING SHOP AKA CARRIAGE LIFTING SHED
- 24. SUMP/OIL INTERCEPTOR
- 25. ACCESS ROAD
- 26. SUB STATION B2
- 27. OUTLINE OF DEMOLISHED STEAM SHED
- 28. TURNTABLE
- 29. BUNDED OIL TANK
- 30. TOILET BLOCK
- 31. DIESEL/OIL OVERHEAD DELIVERY LINE
- 32. DIESEL/OIL DELIVERY AREA
- 33. ASH SHELTER
- 34. FUEL OIL TANKS
- 35. SITE OF DEMOLISHED MASONRY ARCH TO SUPPORT RAISED TRACKS
- 36. SUB STATION B3
- 37. SITE OF DEMOLISHED BOILER HOUSE
- 38. SUBSTATION B5
- 39. MESS ROOM
- 40. CORONATION SIDINGS
- 41. BURIED TURNTABLE PITS
- 42. BURIED/SITE OF TRANSVERSER PIT
- 43. SITE OF DEMOLISHED WATER SOFTENER
- 44. SITE OF DEMOLISHED REFUSE DESTROYER
- 45. SITE OF DEMOLISHED SAND FURNACE
- 46. SITE OF DEMOLISHED MESS ROOMS
- 47. SITE OF DEMOLISHED COALING BUILDING AND WATER TOWER
- 48. SITE OF DEMOLISHED EMBANKMENT LEADING TO COALING BUILDING
- 49. CONSERVATION AREA FORMERLY COAL STOCK PILE
- 50. TANK BASES TO PREVIOUSLY REMOVED OIL TANKS
- 51. SITE OF EMBANKMENT LEADING TO FORMER BOILER HOUSE
- 52. BUNDED OIL TANK
- 53. SITE OF DIESEL/OIL TANK
- 54. DIESEL/OIL TANK PUMP HOUSE
- 55. COVERED WALKWAY TO REAR OF STORES
- 56. COVERED WALKWAY
- 57. GAS METER HOUSE
- 58. PIPE BRIDGE
- 60. SITE OF DEMOLISHED AIR RAID SHELTERS
- 61. STORAGE SHELTER
- 62. BOUNDARY RETAINING WALL
- 63. BOILER WASHING PLANT HOUSE
- 64. BOILER/PUMP HOUSE

- A: COMPOSITE TRUSS
- B: COMPOSITE TRUSS
- C: COMPOSITE TRUSS
- D: COMPOSITE TRUSS
- E: CAST IRON/STEEL COLUMN
- F: COMPOSITE TRUSS
- G: PULLEY WHEELS
- H: HERRING BONE FLOORING
- I: SUMP/OIL INTERCEPTOR
- J: STEEL DOOR
- K: DIESEL UNLOADING JIB & PIPES
- L: GANTRY CRANE
- M: TRUSS
- N: WINDOW
- O: GANTRY CRANE
- P: GANTRY CRANE
- Q: WEIGH SCALES
- R: URINALS
- S: POINTS LEVER
- T: CLOCK
- U: SIGN
- V: HEADBOARD

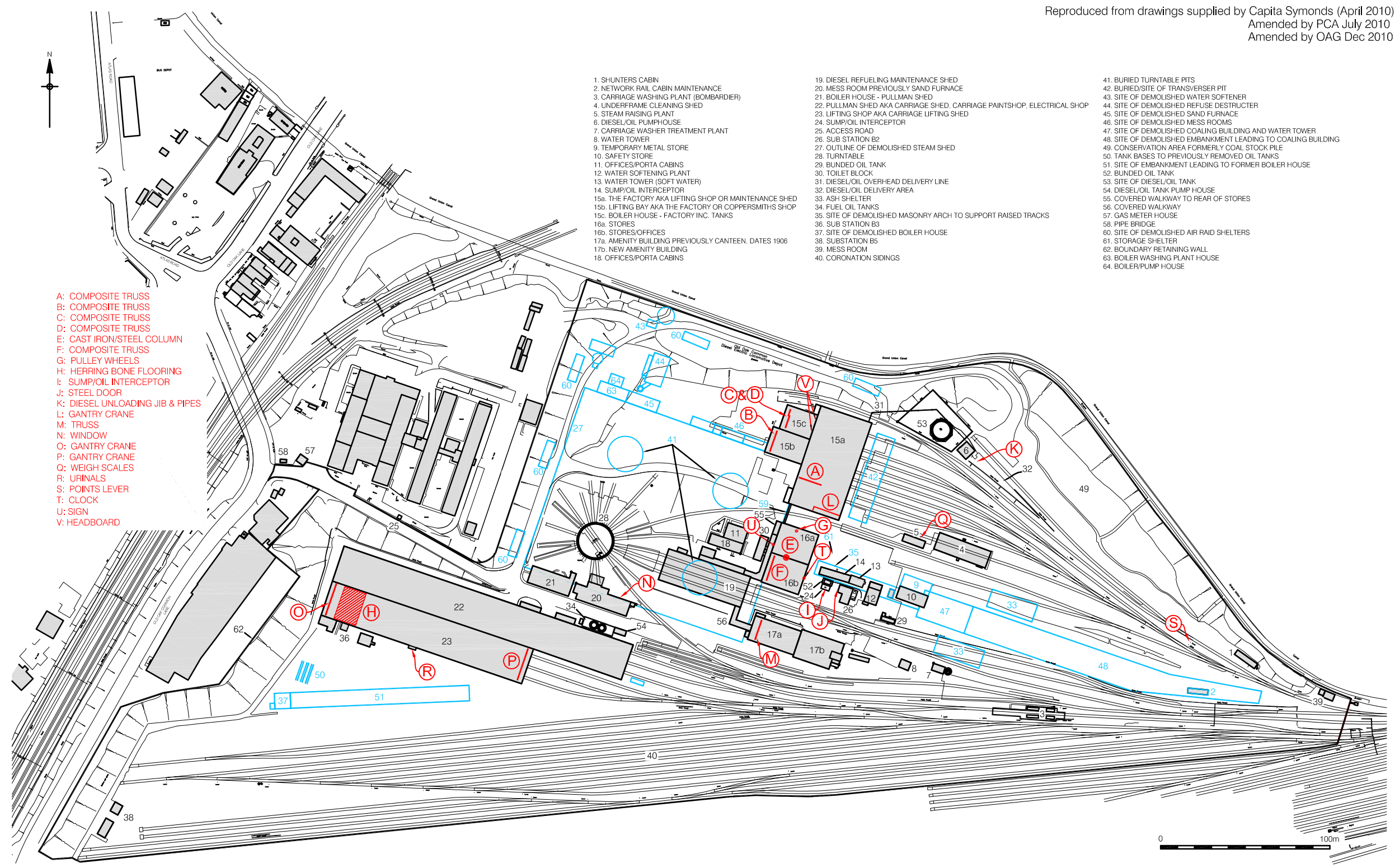

Drawn	MJ	Chkd.	AS	Apprvd.	PE	Date	20.12.10	PRELIMINARY
-------	----	-------	----	---------	----	------	----------	-------------

Client
CROSSRAIL LTD

Project
**CROSSRAIL C254
ARCHAEOLOGY WEST**

Bankside Studios, 76-80 Southwark Street, London, SE1 0PN
Tel : 020 7960 2424 Fax : 020 7960 2425 www.gifford.uk.com

Drawing Title
**OLD OAK COMMON
SALVAGE ITEM LOCATIONS**

scale (at A3)	date	drawn
1:2500	20/12/10	MDJ
drg. no.	rev.	
16188/CHA/001	-	

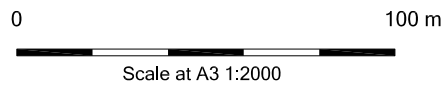
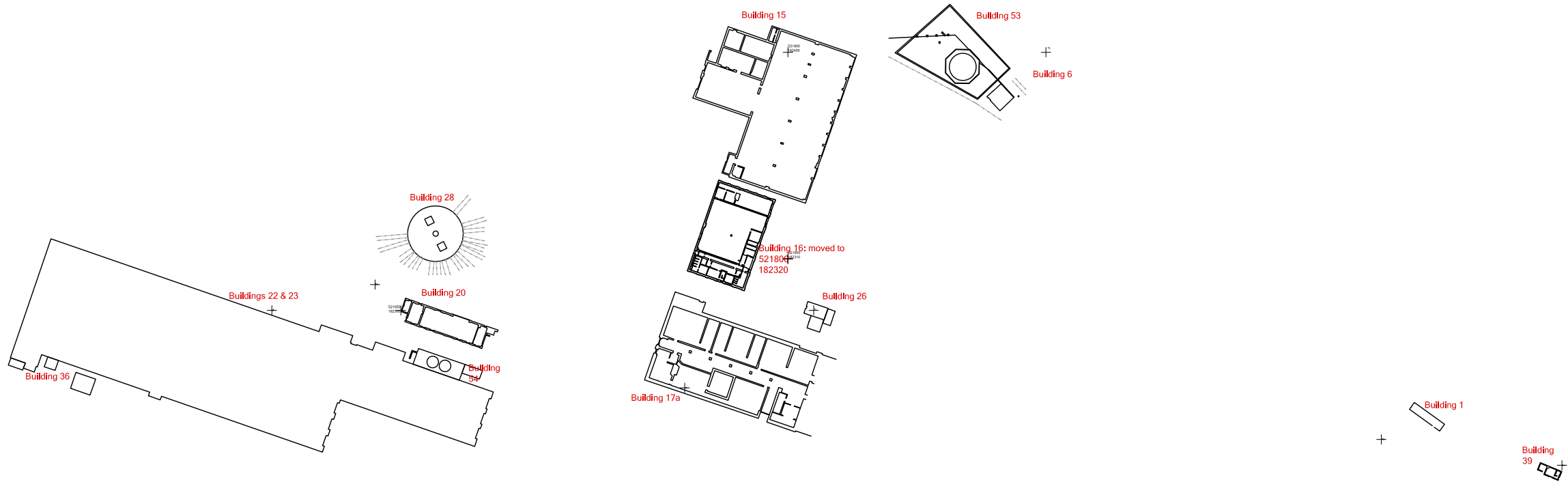

CHECKED BY: DRAFT

Figure 3: Combined plan showing buildings covered by laser scan

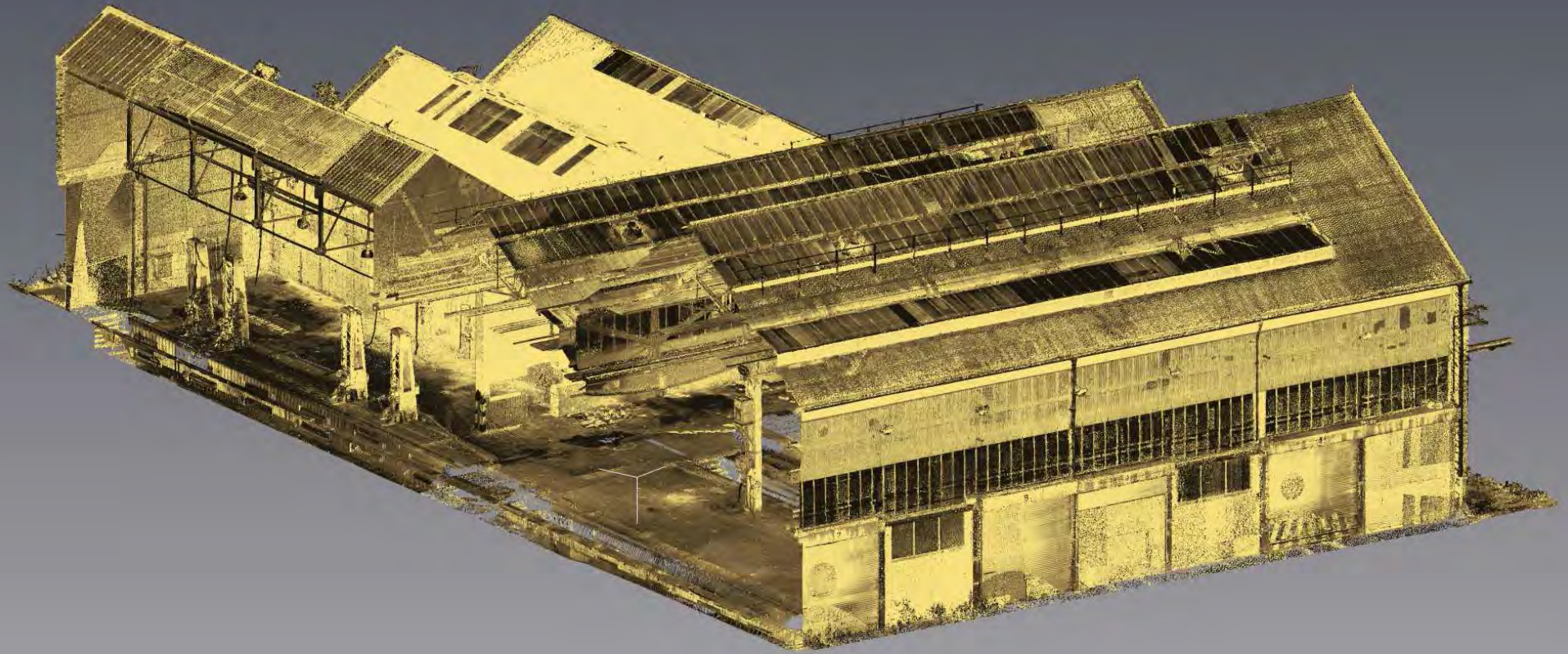
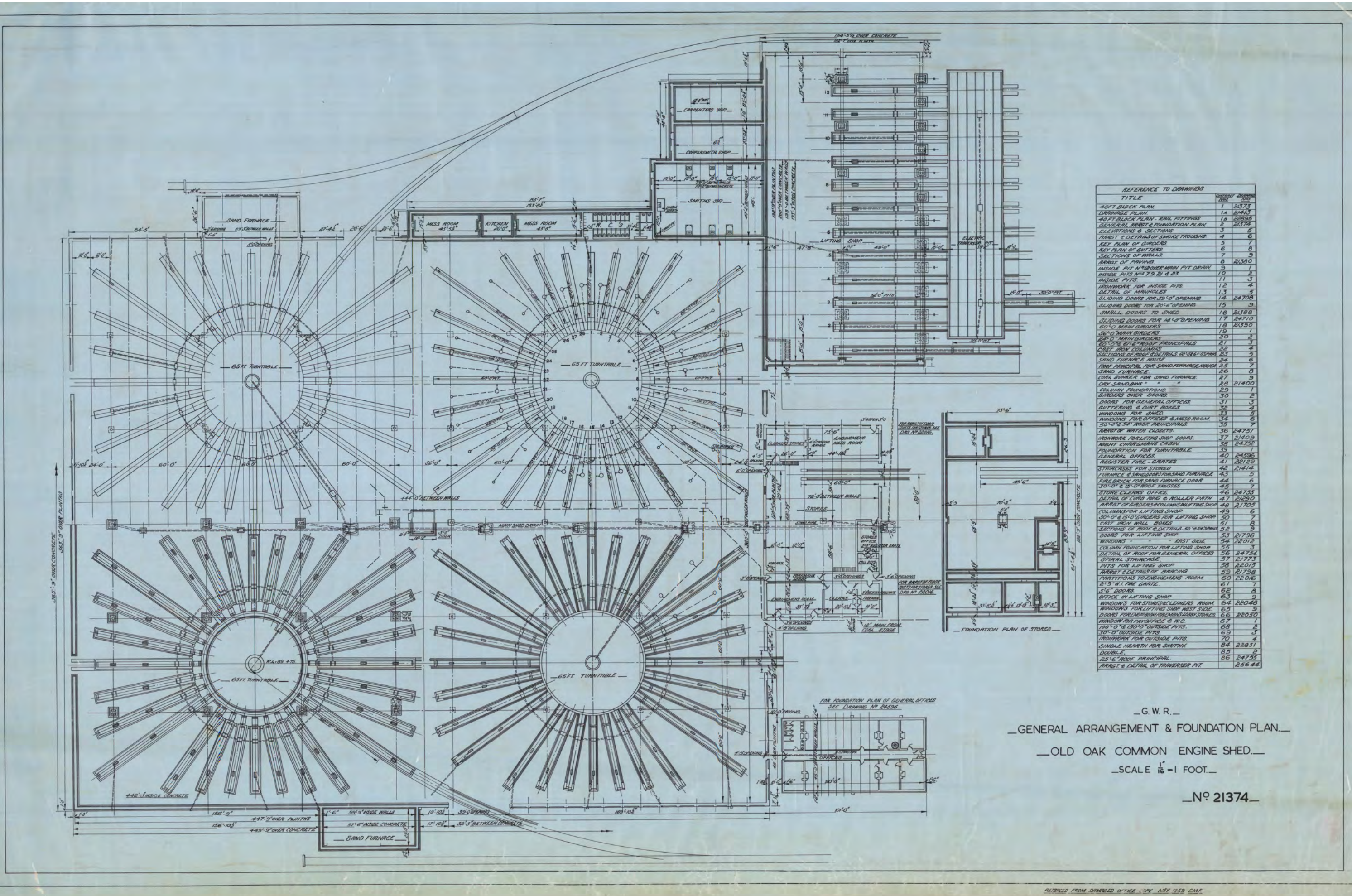

Image Dimensions 66.2757m x 48.5939m Image Scale 30.16190 pixels/metre

Figure 4: Isometric slice of Building 15 from laser scan



Figure 5: Isometric slice of Building 16 from laser scan



REFERENCE TO DRAWINGS	
TITLE	CONTRACT DRAWING SHEET NO.
40 FT BLOCK PLAN	1 21373
DRAINAGE PLAN - RAIL FITTINGS	1A 21373
GENERAL ARRANGEMENT & FOUNDATION PLAN	1B 21374
ELEVATIONS & SECTIONS	2 21374
DETAILS OF DETACHMENT SMOKE TROUGH	4 6
KEY PLAN OF GIRDERS	5 7
SECTIONS OF WALLS	6 8
DETAILS OF PAVINGS	7 9
INSIDE PIT & TRANSVERSE PIT DRAIN	8 21380
INSIDE PITS Nos 25 B1 & 23	10 2
INSIDE PITS	11 3
IRONWORK FOR INSIDE PITS	12 4
DETAILS OF ARCHWAYS	13 5
SLIDING DOORS FOR 15'0" OPENING	14 24708
SLIDING DOORS FOR 20'6" OPENING	15 9
SMALL DOORS TO SHED	16 21388
SLIDING DOORS FOR 14'0" OPENING	17 24710
60'0" MAIN GIRDERS	18 21350
36'0" MAIN GIRDERS	19 2
60'0" MAIN GIRDERS	20 2
60'0" MAIN GIRDERS	21 3
CAST IRON COLUMNS	22 4
SECTIONS OF ROOF & DETAILS 60'0" & 36'0" SPANS	23 5
SAND FURNACE ROOF	24 6
RAIL PRINCIPAL FOR SAND FURNACE ROOF	25 7
SAND FURNACE	26 8
COAL BUNKER FOR SAND FURNACE	27 9
COAL SANDPANS	28 21400
COLUMN FOUNDATIONS	29 1
GIRDERS OVER DOORS	30 2
DOORS FOR GENERAL OFFICES	31 3
DETAILS OF WATER CLOSERS	32 4
WINDOWS FOR SHED	33 5
WINDOWS FOR OFFICES & MESS ROOM	34 6
30'0" & 24'0" ROOF PRINCIPALS	35 7
TARGET OF WATER CLOSERS	36 24751
IRONWORK FOR LIFTING SHOP DOORS	37 21409
NIGHT CHARGEMANS CABIN	38 24750
FOUNDATION FOR TURNTABLE	39 1
GENERAL OFFICES	40 24536
REGISTER FRAME - GATES	41 24129
STAIRCASES FOR STORES	42 21414
FURNACE & SANDPANS FOR SAND FURNACE	43 5
FIREBRICK FOR SAND FURNACE DOOR	44 6
30'0" & 24'0" ROOF TRUSSES	45 7
STORES & LEANS OFFICES	46 24753
DETAILS OF CURB AND ROLLER PATH	47 24250
ARRAY OF GIRDERS & COLUMNS IN LIFTING SHOP	48 21705
COLUMNS FOR LIFTING SHOP	49 6
30'0" & 24'0" GIRDERS FOR LIFTING SHOP	50 7
CAST IRON WALL DOORS	51 8
SECTIONS OF ROOF & DETAILS 30'0" & 24'0" SPANS	52 9
DOORS FOR LIFTING SHOP	53 21796
WINDOWS - EAST SIDE	54 22012
COLUMN FOUNDATION FOR LIFTING SHOP	55 3
DETAILS OF ROOF FOR GENERAL OFFICES	56 24754
SPIRAL STAIRCASE	57 21773
PITS FOR LIFTING SHOP	58 22015
ARRAY & DETAILS OF BRACING	59 21798
PARTITIONS TO ENGINEERS ROOM	60 22016
21'0" WIDE GATE	61 7
5'6" DOORS	62 4
OFFICE IN LIFTING SHOP	63 9
WINDOWS FOR STORES & ENGINEERS ROOM	64 22048
WINDOWS FOR LIFTING SHOP WEST SIDE	65 3
DOORS FOR STORES & ENGINEERS ROOM	66 22050
WINDOW FOR OFFICE & W.C.	67 1
100'0" & 150'0" OUTSIDE PITS	68 2
30'0" OUTSIDE PITS	69 3
IRONWORK FOR OUTSIDE PITS	70 4
SINGLE HEARTH FOR SMITHY	84 22831
DOUBLE	85 2
25'6" ROOF PRINCIPAL	86 24755
ARRAY & DETAIL OF TRANSVERSE PIT	256 44

— G. W. R. —
 — GENERAL ARRANGEMENT & FOUNDATION PLAN. —
 — OLD OAK COMMON ENGINE SHED. —
 — SCALE 1/16" = 1 FOOT. —
 — No 21374 —

REPRODUCED FROM DAMAGED OFFICE COPY, MAY 1959 C.M.F.

Figure 6: Plan of primary site re-drawn in 1950s. (Ref: 2515-409-1516)

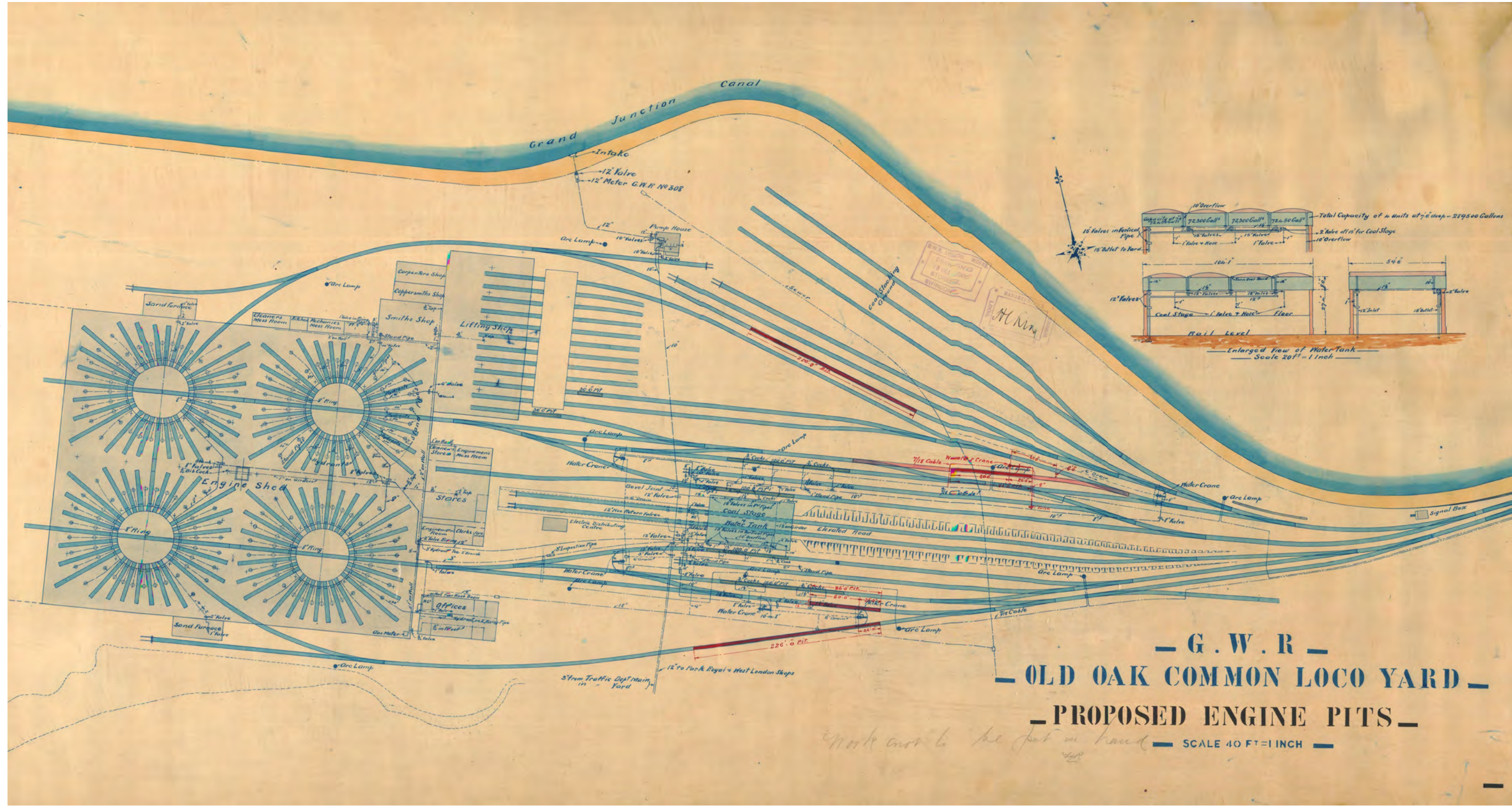

Figure 7: 1906 plan (ref: 2515-410-0062)

1 MAY 1930

THE UNDERSIGNED, HAVING MADE HIMSELF ACQUAINTED WITH THE PURPOSES AND GENERAL FEATURES OF THIS DRAWING, CERTIFIES THAT IT SHOULD BE CARRIED OUT AT THE ESTIMATED COST SHOWN BELOW.

Officer	Signature	Date of Signature	Officer's Signature
Chief Engineer	W. J. 734	27.5.30	<i>[Signature]</i>
Chief Mechanical Engineer			
Signal Engineer			
Stores Superintendent			
Total £			
4th Master			
4th Acton			
Divisional Superintendent			
District Goods Manager			
Divisional Engineer			<i>[Signature]</i>
Divisional Locomotive Supt.			
Superintendent of the Line			
Chief Goods Manager			

General Managers

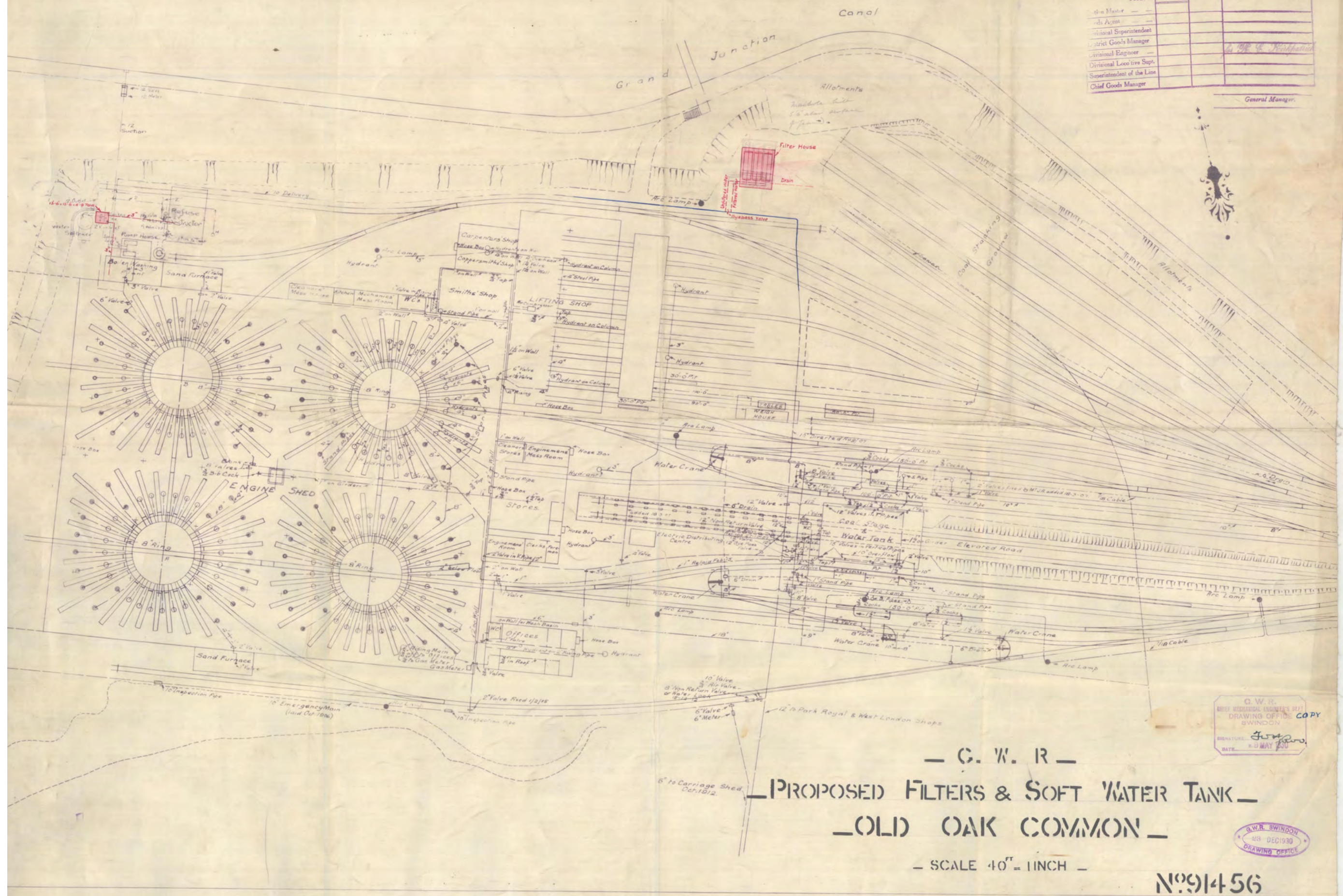

— G. W. R. —
PROPOSED FILTERS & SOFT WATER TANK
— OLD OAK COMMON —

— SCALE 40" = 1 INCH —

Nº 91456

G. W. R.
 CHIEF MECHANICAL ENGINEER'S DEPT.
 DRAWING OFFICE COPY
 SWINDON
 SIGNATURE: *[Signature]*
 DATE: 27 MAY 1930

G. W. R. SWINDON
 DEC 1930
 DRAWING OFFICE

Figure 8: 1930 plan (ref: 2515-403-2178)

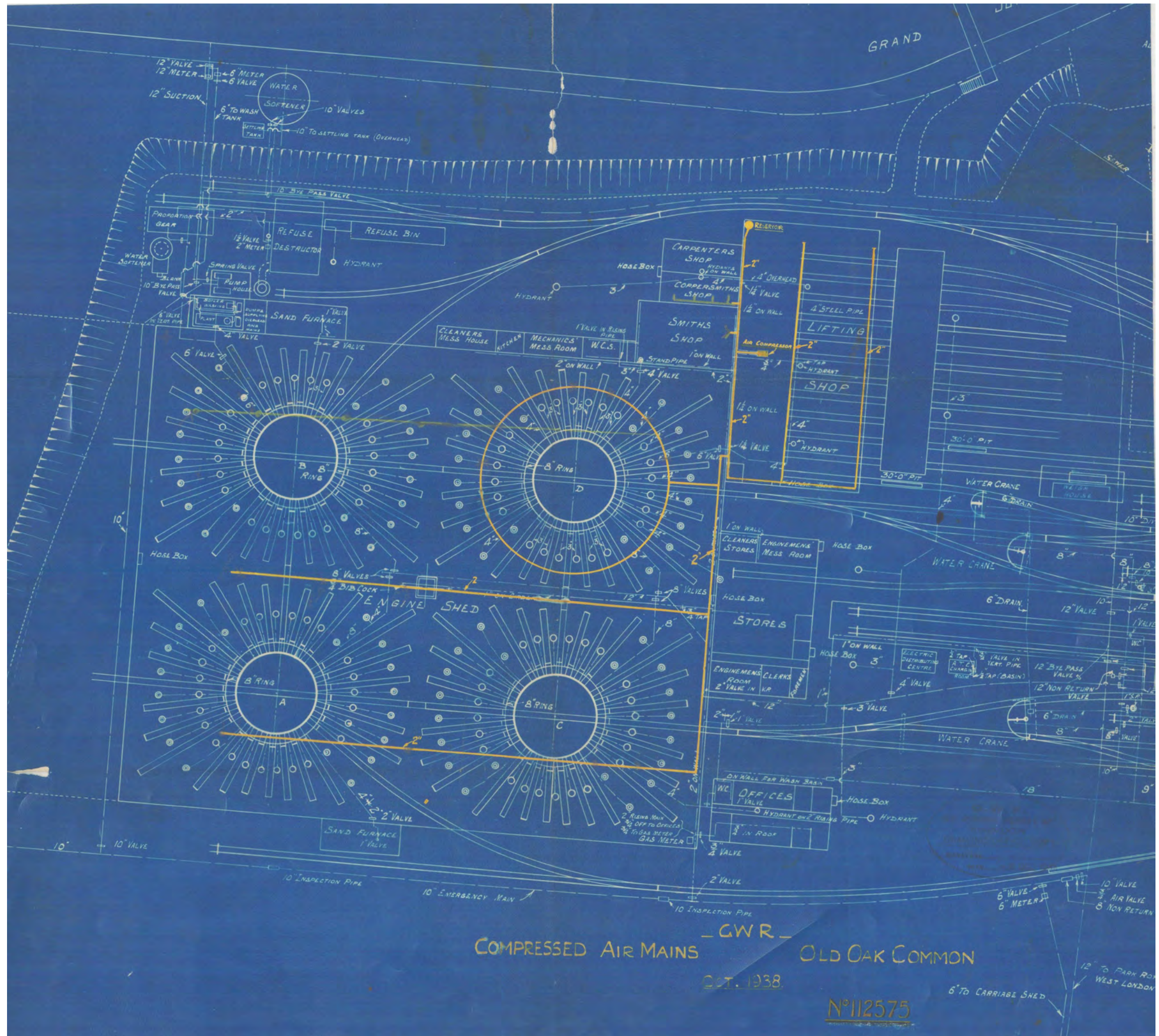

Figure 9: 1938 plan (ref: 2515-403-2183)

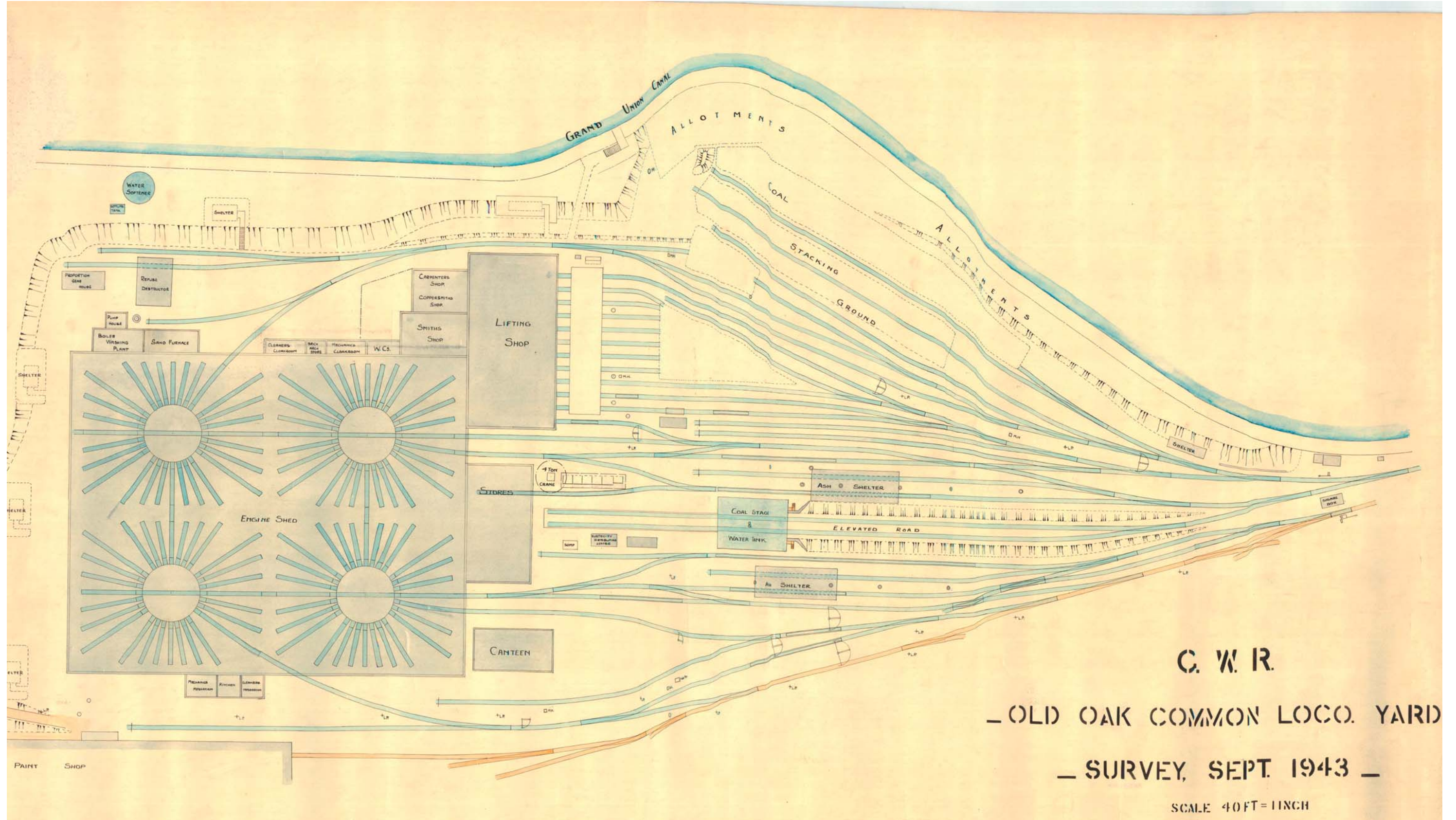

Figure 10: 1943 plan (ref: 2515-410-0672)

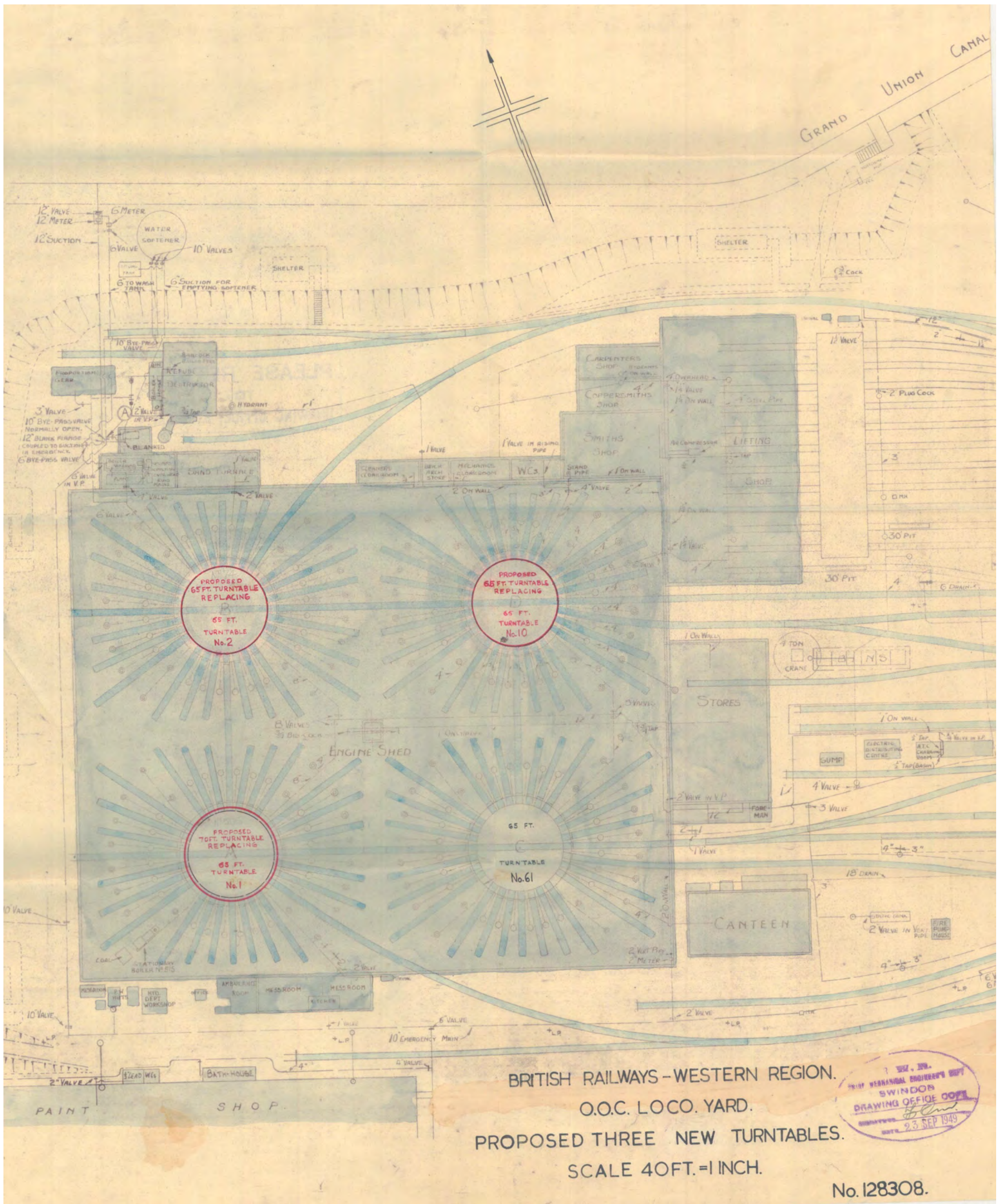
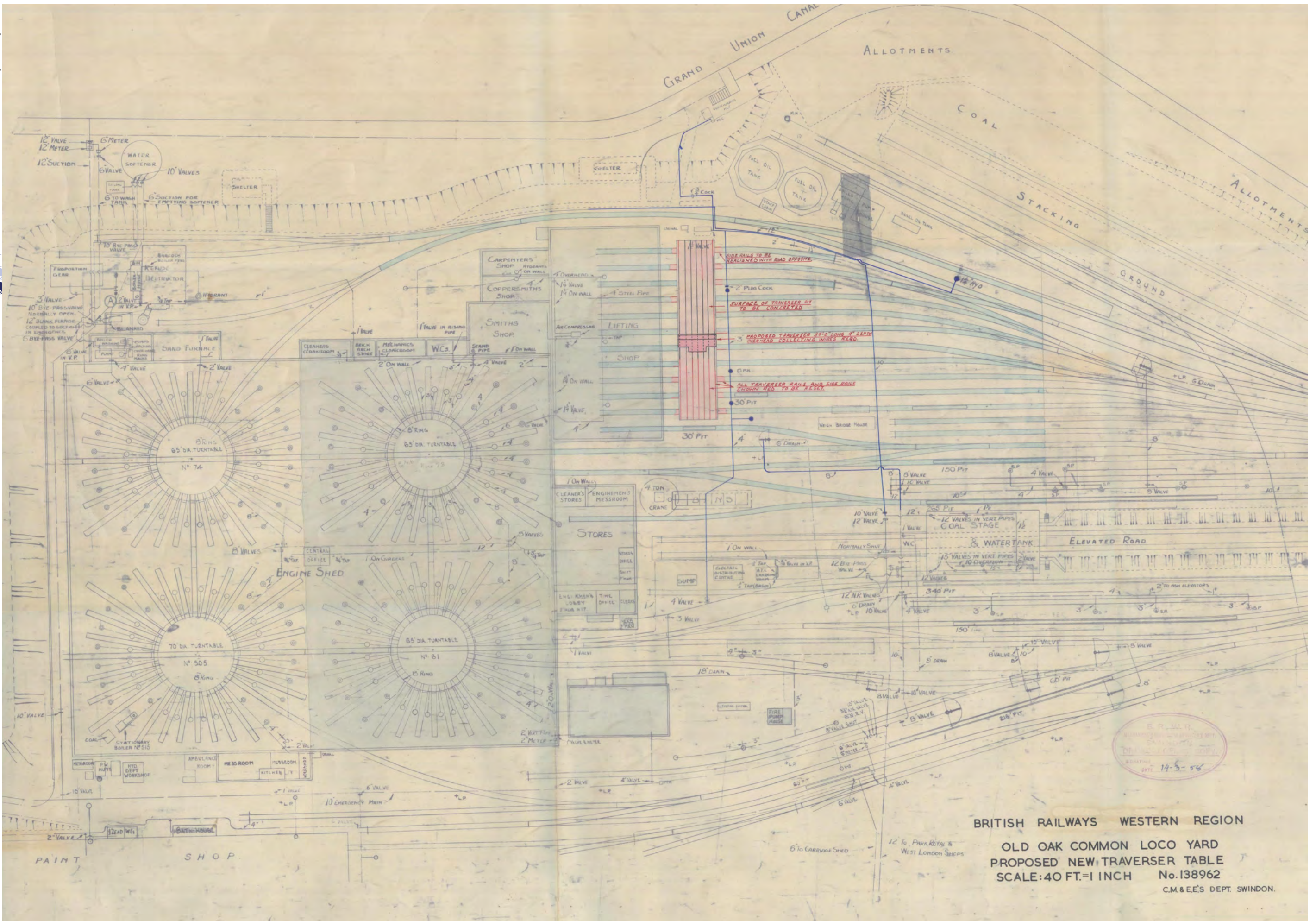

Figure 11: 1949 plan (ref: 2175-403-2193)



B. R. W. R.
 BRITISH RAILWAYS
 SWINDON
 DATE 14-5-58

BRITISH RAILWAYS WESTERN REGION
 OLD OAK COMMON LOCO YARD
 PROPOSED NEW TRAVESER TABLE
 SCALE: 40 FT. = 1 INCH No. 138962
 C.M. & E.E.'S DEPT. SWINDON.

Figure 12: 1958 plan (ref: 2515-403-2195)

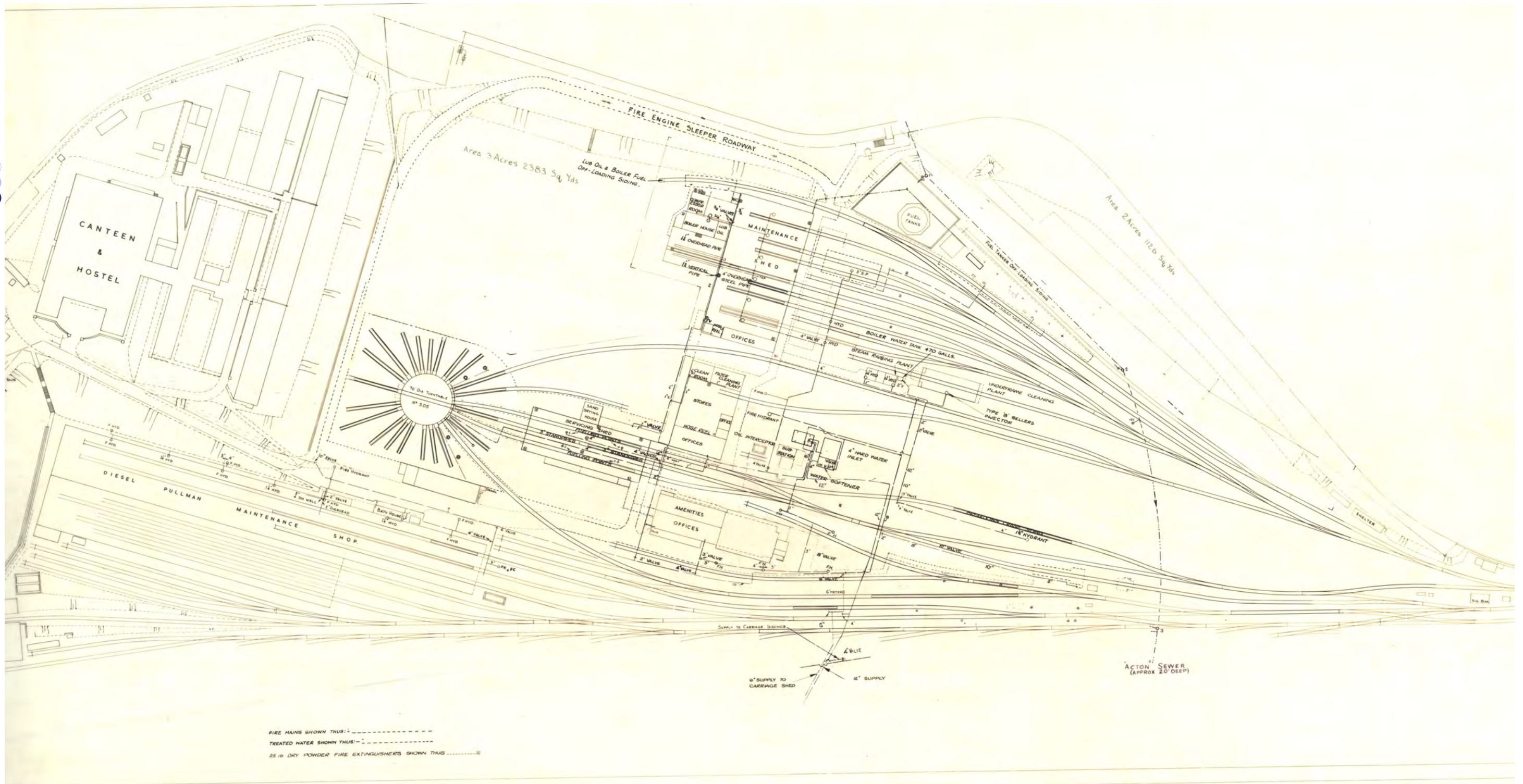

Figure 13: 1966 plan (ref: 2515-410-2172)

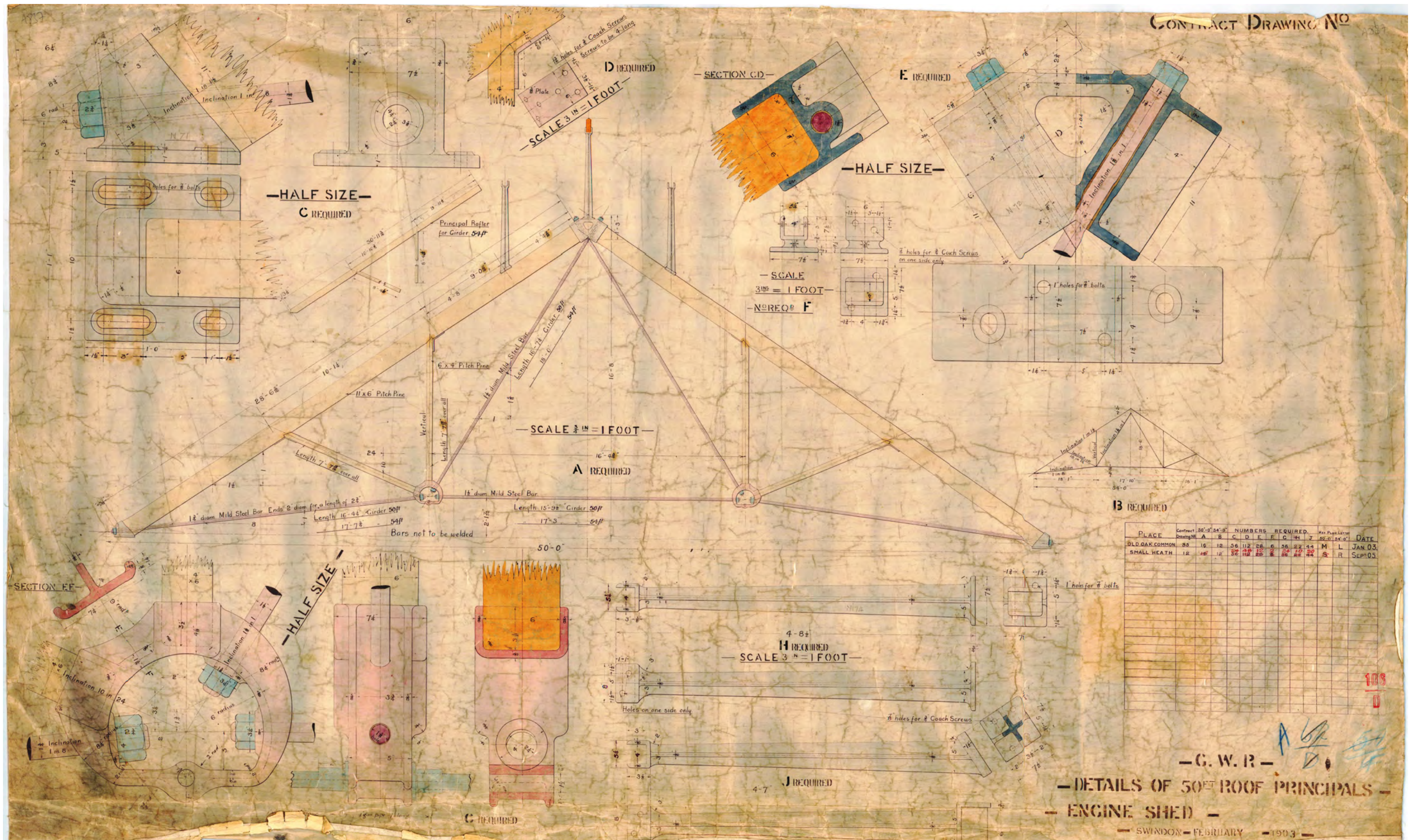

Figure 14: 1903 detail of engine shed roof (ref: 2515-409-0692)



5. **STRUCTURE 15A: THE 'FACTORY' (LIFTING SHOP OR MAINTENANCE SHED)**

5.1 **Introduction and summary**

- 5.1.1 The building known as The Factory (Structure 15) was one of the key original elements of the Old Oak Common Complex and it divided into three adjoining parts: Structures 15a – 15c. By far the largest element was the Lifting Shop or Maintenance Shed (15a) while adjoining to the west of this was the Lifting Bay (former Smiths Shop, 15b) and the Boiler House (15c). The three elements have been described separately in the current report.
- 5.1.2 The Factory was located on the northern side of the main central group of buildings at Old Oak Common and it would have wrapped around the north-eastern corner of the great Engine Shed prior to the demolition of this structure in the mid 1960s.
- 5.1.3 The DDBA assessed that the Factory was of regional significance. It has been recorded in the current project at EH Level 3.

5.2 **Outline History and map evidence**

- 5.2.1 The lifting and repair shop, soon known as the Factory, was one of the principal structures envisaged by GJ Churchward and represented a step-change in the quality and convenience of the facilities on offer at Westbourne Park. It represented the London Division's Shop. The building measured 195ft by 101ft internally, with twelve pits, each of 52ft length. Beyond the end of the pits lay the fitters and machine bay. William Walkerdine, of Bridge Street, Derby built the structure and were instructed by the GWR to lay the floors with a bed of cement concrete 6in. thick, laid with 5in. creosoted wooden blocks. When opened the fitters and machine bay contained four lathes, two wheel lathes, two buffing machines, two shapers, two drilling machines, a automatic cold sawing machine, a slotting machine, a punching and shearing machine, a screwing machine, a drill slotter and a grindstone (The Railway Gazette, 1 June 1906).
- 5.2.2 The Factory is shown on the 1906 site plan (Ref: 2515-410-0062. *Fig 7*) with the main building (15a) labelled as the Lifting Shop, the southern of the two western projections (15b) labelled as the Smiths Shop and the northern of the two projections (15c) split into two long east-west sections. The northern part of 15c was labelled as the Carpenters Shop and the southern part was the Coppersmith's Shop. The plan shows the twelve roads entering the building from the east and a large rectangular traverser pit just to the east of the building.
- 5.2.3 Slightly more information is provided by another plan (ref: 2515-409-1516. *Fig 6*) which shows two rows of double I-beam stanchions either side of the roads: one of the N-S rows was along the central line of the building while the other was in the east elevation. This plan was a 1959 re-drafting of an earlier damaged plan. The date of the earlier plan is not given but it appears to be the original Edwardian complex. When it was first built this building would have been the most up-to-date repair shop in the country and it was both the first and largest of a series of depots constructed in this period by the GWR.



- 5.2.4 Subsequent site plans up to the mid 1960s show little change in the Factory complex although proposals were drawn up in 1943 to extend 15b and 15c to the west. These proposals were not carried out although one minor change, first shown on a plan of 1952, is the construction of a small extension at the northern end of the west side of Structure 15a. This would also have adjoined the north side of Structure 15c and although it is unlabelled on this drawing later plans show it to have been a WC block. It is not shown on a plan of 1949.
- 5.2.5 The plans up to (and including) 1958 all appear to show that the 12 roads inside the building were all of the same length, extending west to just beyond the central line of the building.
- 5.2.6 A plan of 1966 (ref: 2515-410-2172. *Fig 13*) shows various significant changes that had been undertaken to the building as part of wider modernisation works at Old Oak Common. This plan shows the main building (15a) now labelled as a Maintenance Shed with offices along the south wall and different lengths to the 12 roads through the building. The 1966 plan shows three east-to-west roads through the former Smiths Shop (15b), and although this block is not separately listed it is likely to have essentially been a continuation of the main Maintenance Shed. The 1966 plan shows a compressor room in the west part of the former carpenter's Shop (ie N half of 15c) and a boiler house and lube oil room in the former coppersmiths Shop (S half of 15c). The projecting block at the northern end of the west elevation is labelled on this plan as a WC.

5.3 Description

5.3.1 External description

- 5.3.2 The main building of the Factory (15a) was a large rectangular plan structure (61 x 31.5 m) with two very large north-to-south bays of different sizes. The eastern bay was slightly wider (c.16 m) and taller than the west bay (c.15 m wide). The roof had pairs of gables at each end (*Plate 15a.1, 15a.5*) and long continuous sets of roof lights along its length to each slope with walkways adjacent (*Plate 15a.2*). There were two sets of roof lights towards the ridge of each slope, incorporating large circular vents, and a further set of lights lower down. The lower rows of lights were raised slightly and incorporated long slat vents along their vertical face.
- 5.3.3 The **southern elevation** of the Factory comprised the two gable ends, facing onto the northern side of the Stores building (Building 16), creating a passage between these two key primary structures at the centre of the complex. The southern elevation of the Factory represented the most coherent representation of the building in its primary form, constructed from red brick, laid in an English bond, the same as all of the primary buildings at the site. The taller eastern gable had crow-stepped inset detailing above three panels, each of one brick depth, with a principal window of 24 lights set in a metal frame high in the central panel (*Plate 15a.8*). A two-light casement was situated towards the top of the window, which was arched and had a three header high lintel. The stepped inset in the central panel was misaligned, perhaps a mistake in construction, and manifested by the central step being 14 headers wide, the left-hand step being 10 headers wide and the right-hand step being 12 headers wide. The plinth of each panel (and the pillars between) was of a very



dark blue/grey engineering brick with a shoulder at the bottom of each panel. Three further metal-framed windows were set at the bottom of each panel – the sills of these (and the upper window) were of the same blue engineering brick (*Plate 15a.7*). The lintels were again of brick headers, three rows high, and the windows frames were of timber with much larger lights. Other than the windows, the only features were a number of tie bar plates on the ends of the gable, two ventilation grilles with horizontal slats that sat in line with the base of the principal window and an 18” diameter iron ring next to the left-hand window.

- 5.3.4 The lower western bay of the southern elevation had a broadly similar form to the eastern bay with three vertical panels divided by tall piers and simple crows-step detailing at the top of each bay. However, the narrower width of this bay meant that each panel and each pier was correspondingly reduced slightly in size. The bay had two large ground floor windows matching those in the east bay of the elevation and probably remaining largely in their primary form. The western panel in this bay did not have a large matching window but did have a much smaller light higher in the wall and this would have illuminated a small primary first floor office. This bay had two square slat vents at the same height as the matching pair of vents in the east bay. The western edge of the elevation was a re-formed pier where the main engine shed would have adjoined and just to the east of this were several patches of reformed brick where pipes entered the wall, as well as an associated RSJ which supported the pipes. These pipes and RSJ spanned between the Factory and the Stores building to the south.
- 5.3.5 The **northern elevation** was much less prominent than the southern and faced onto a set of rail tracks and a bank at the northern end of the site (*Plate 15a.5-6*). This elevation also remained relatively close to its primary form with each of the two gables divided into three distinct panels and crows-step detailing at the top of each panel. The elevation was again constructed from red brick laid in English bond and with a plinth formed from blue engineering bricks. There were six large windows at ground floor (three in each bay) beneath segmental 3-brick arches and with the sills formed from large special blue bricks to match the plinth. Similarly to the south elevation there were four metal slat vents (two to each bay) and the taller eastern bay had a primary, metal framed 24-light window, high in the central panel.
- 5.3.6 Only the southern half of the **western elevation** of the main Factory building (Structure 15a) was visible externally due to the adjoining structures (15b and 15c) to the north and it is important to note that even this external wall was originally internal. This section of wall originally adjoined the northern end of the east wall of the engine shed prior to its demolition in the mid 1960s. The fact that this wall was not intended to be visible is shown by the plain character of this wall, without any of the subtle detailing present on the main primary elevations, and the fact that the elevation was covered in a white paint from when this was an internal wall (*Plate 15a.9-10*). The wall was constructed from English bond brickwork and there was a parapet at the top hiding the eaves. The lowest 15 courses were painted black (with later white paint over this).
- 5.3.7 There were two large inserted square metal slat vents in the northern half of the wall, high up and probably just below truss level internally, with cement lining. At ground



floor there were two boarded windows in the northern half of the elevation with concrete lintels and concrete sills. At the southern end of the elevation there is a large projection constructed from concrete blockwork with roller shutters in the west wall. This projection is not shown on the 1966 plan. Above the concrete block projection there is a tall infilled opening (almost certainly a former window), in the primary wall of 15a ; this was 21 bricks tall and with a segmental arch lintel.

- 5.3.8 Approximately 2.25 m to the north of this segmental arch there was a cast iron bearing box which appeared identical to the internal one in the east wall of the Stores (Structure 15). The box in the Stores building supported one end of the load-spreading lattice girder in that building so presumably this bearing box in the wall of the Factory once supported the east end of a similar lattice girder in the adjoining Engine Shed. The bearing box was set on a short row of bricks laid on their edge and just above it was a drainage hopper (without downpipe). The top of the bearing box was 16 courses below the top of the parapet but unfortunately when the recording was undertaken in 2010 the feature was largely hidden by a bush growing out of the wall (*Plate 15a.10*). Also close to the bearing box was a circular pipe (c.25 cm diameter) infilled and embedded within the wall. There were few other coherent features in the elevation although there were a small number of minor repairs or small patches of render from former features.
- 5.3.9 The **eastern elevation** of the Factory had an open character very different to that of the north and south walls and faced onto the sets of roads that entered the building (*Plate 15a.1-4*). The elevation essentially comprised non-structural, lightweight cladding of various types, fixed to the building's main steel frame which was immediately inside the building and which divided the elevation into 13 bays. The main description of the structural frame is included below in the internal description. The elevation was essentially divided into three main horizontal bands. The upper third was of light-weight corrugated sheeting, painted a brown/grey and incorporating a series of large flood lamps to illuminate the approach to the building. The cladding probably dated from the third quarter of the 20th century and it was set immediately below a narrow band of white-painted tongue-and-groove boarding at the eaves. The main central section of the elevation was a full width band of glazing while the lower section comprised the individual doorways for the trains above an RSJ in each of the 13 bays.
- 5.3.10 Twelve of the 13 bays would originally have had a road entering the building but in its latter years five of these bays were blocked with brickwork and the roads closed. The infill brickwork is suggestive of a 1970s date and historic photographs from 1967 in *The Heyday of Old Oak Common and its Locomotives* show the bays still open. The eight bays which do not have infill brickwork have vertical roller shutter doors and projecting boxes above the doorways for the rollers but these shutters also probably date from the 1970s. The photograph from 1967 referred above shows the openings with conventional timber double doors.
- 5.3.11 The 7 bays where roads still appear to have remained fully functional (ie roads entering the building) were Bays 3, 5, 6, 7, 9, 10, 12 (numbered from the south end). There were three bays where tracks remained in-situ outside the building but terminated by external buffers (Bays 2, 4, 8) and three bays where there was no sign



of any tracks (Bays 1, 11, 13). Historic plans suggest that there were formerly roads in Bays 1 and 11 but it appears that Bay 13 at the northern end never had a road entering it.

- 5.3.12 Various minor pieces of evidence remained from the former gates including three bolted plates fixed to the east side of each main stanchion (at top, bottom and centre) and with loops to form gate hinges (*Plate 15a.11*). Many of these plates had been entirely or partly removed (although traces of them survived) and only one example survived with the loops fully intact – this was at the uppermost bracket to the south side of Bay 11.
- 5.3.13 The underside of the lintel in each bay had a small hole towards its centre, suggestive of where a door bolt would fix, and either side of this was a simple L-section length of steel. These lengths of steel, which were also fixed to the underside of the lintel and extended towards the jambs, probably acted as door stops to prevent the doors swinging into the building and damaging the hinges. They were rivetted and appeared to be primary features. There were also small holes at the central point in the floor, beneath the lintel, from former bolts to fix the doors shut.
- 5.3.14 Another minor feature to the elevation was a number of brackets bolted to the face of the main lintels that appear to have held former lights. The brackets were in the form of a cylindrical mount into which a horizontal pipe or bar would apparently have been fixed. Some way above each of these brackets was a pair of small fixings that would probably have secured a cable.
- 5.3.15 The only primary brickwork in the elevation was in the 80 cm wide piers at the north-east and south-east corners. These incorporate bullnose bricks and a ‘stop bullnose’ at 2.65 m above floor. Within the south-eastern pier there were two stone bearing blocks (41 x 25 cm) with truncated iron projections from the hinges of the former doors. At the north-east corner there were similar ‘stop bullnose’ bricks as at the south-east corner but any possible truncated hinges were obscured by the frame of the roller shutters. At the northern end of the elevation three pintles survived in the brickwork behind the roller shutter doors which would clearly have supported gates in this elevation (*Plate 15a.12*).
- 5.3.16 The traverser pit would formerly have been located about 4.5 m to the east of this wall to allow engines to be moved between roads but this had been infilled. A series of I-section steel bars (probably reused sections of rail track) were sunken into the floor c.2 m to the east of the east elevation and then cut off at the surface. These aligned with each of the main posts in this elevation and the concrete slab outside the building respected them (ie wrapped around them). These appear to be shown on the early historic plan (Ref: 2515-409-1516. *Fig 6*) and it may be that they were simply posts to fix the gates to.

5.3.17 Internal Description

- 5.3.18 The **general layout** of the interior of the main Factory building (15a) was a vast open-plan hall divided into two similarly sized bays by a north-to-south row of stanchions along the spine of the structure. Although the bays were of similar size they were not identical: the west bay was c.15 m wide whereas the east bay was c.16 m wide, and



the east bay was also significantly taller. The greater height of the eastern bay allowed for a row of clerestorey lights between the bays along the central line which illuminated the tall east bay.

5.3.19 The use of the building and the open-plan nature of the interior probably changed relatively little from its original construction to its demolition in 2011 and functionally, the key features were the roads which would have allowed trains to enter the building for maintenance (*Plate 15a.31*). The roads entered through the bays in the east wall and extended towards the west over long inspection pits. As detailed above historic plan evidence shows that there would originally have been 12 roads: one in each bay other than the northernmost bay, and all these roads extended west to just beyond the central line of stanchions. Various secondary alterations were undertaken to these roads and only six of these roads remained intact and with in-situ inspection pits. Their form at the time of the 2010-11 recording is summarised in the table below.

Bay	Details of road
Bay 1	Southernmost bay: no tracks in-situ and only a faint crack in the floor from the line of former tracks/pit.
Bay 2	no tracks in-situ and only a faint crack in the floor from the line of former tracks/pit.
Bay 3	The tracks and pit here remained in-situ. This was the only inspection pit with small flanking trenches (each 63 cm wide) which ran parallel to the main inspection trench. Unlike most of the pits there were no light in the side walls. The pit was 25.8 m long.
Bay 4	there were no tracks insitu but the outline of the former infilled inspection pit was visible.
Bay 5	Tracks and pit in-situ. 25.4 m long from east stanchion.
Bay 6	tracks in-situ but the inspection pit infilled. The pit was 22.8 m long from east wall
Bay 7	this road was in-situ together with inspection pit and it continued through into Building 15b (extended in 1960s). Access over this inspection pit was made possible by a set of 9 sleepers roughly laid over the pit in the western half of the building. The extension to the inspection pit was clearly later and was shown by various minor differences in construction (eg the lights in the sides were recessed into voids) and rather than there being brick ledges towards the base of the pit as with the older examples, the extension to this pit had angled brackets at the base, 30 cm above floor (possibly for boards to go across)..
Bay 8	the tracks in this bay were insitu at the east end but the pit had been infilled. The outline of the former pit extended to the central line of stanchions but no further.
Bay 9	the tracks and inspection pit remained in use in this bay although the concrete sides of the pit appeared later than the others (rebuilt). The pit was 22.8m long and although there were no lights there were pipes along its length.
Bay 10	This road was c.22 m long and the western 5.2 m was an extension. The earlier sections to the east were brick lined while the western extension was concrete lined. There was also a clear break in the track at this point. At the west end there is a small mark saying '9 Road' painted on the floor.
Bay 11	no tracks in-situ or clear sign of former tracks.
Bay 12	long road (25.8 m long) with inspection pit visible. Brick lined pit.
Bay 13	northernmost bay): no tracks were in-situ but there were imprints at the east end which were suggestive of former tracks.



- 5.3.20 It should be noted that at the time of the recording in 2010-11 all the pits were surrounded by herras fencing for safety reasons and so could not be inspected closely.
- 5.3.21 The **main structural frame** of the building comprised two north-to-south lines of steel stanchions supporting the roof. One line of six stanchions was beneath the valley between the two bays of the roof (*Plate 15a.13*) while the other line of 12 more closely spaced stanchions was within the east elevation (*Plate 15a.20*). The eastern line allowed this elevation to effectively be a curtain wall while the other three sides of the building were of load-bearing brick.
- 5.3.22 The central line of six widely spaced stanchions supported a series of long north-to-south fish-belly girders along the spine of the building which supported the tracks of the gantry crane in the east bay (*Plate 15a.23*). Each fish-belly girder was braced by eight vertical struts. The line of 12 stanchions in the east wall were identical to the six along the spine of the building but they supported conventional (non-fish belly) girders beneath the tracks. The main stanchions were formed from pairs of 30 cm wide I-section RSJs set slightly apart from each other and braced together with four evenly spaced pairs of steel plates. The ends of the girders (both fish belly in central row and non fish-belly in eastern row) were set directly on top of these stanchions.
- 5.3.23 Above the main stanchions and the crane rails there were 12 shorter upper stanchions which rose to a rivetted bearer at the top on which each truss in the taller east bay sat. The upper stanchions had two long arms which diverge slightly towards their base and overall they had the appearance of a giant set of tweezers. The arms project down either side of the main stanchions and are then riveted to it.
- 5.3.24 In the central spine wall half of the 12 upper stanchions supporting the high trusses in the east bay were above the six main stanchions but the other half were mid-spaced and above the deepest part of the fish-belly girder. The upper sections of the wall were braced by diagonal ties and it was noticeable that the plate at the eaves level was a relatively light L-section brace. This uppermost plate provided lateral bracing but there was not a substantial wall plate at the top of the wall; the main load of the roof was taken directly by the stanchions.
- 5.3.25 The trusses in the west bay were set lower than those in the east bay and therefore they were not supported on the upper stanchions. Instead, half of them were supported directly by the main stanchions but the other half, which were not aligned with a main stanchion, were supported on a metal hanger suspended down from the stanchion and rail in the clerestory window.
- 5.3.26 In the east wall the RSJ lintels above each bay were riveted to the main stanchions and supported by a bracket. Also in the east wall there were separate gate piers just to the east of the main stanchions, formed by an I-section RSJ (36 cm long) and only extending up to the bay lintels. They are fixed to the main stanchions by brackets.
- 5.3.27 **The roof** in each of the two bays of 15a was essentially of the same type as in Block 15b and similar to that in the Stores (Block 16). It is also known to have been similar to that in the engine house which was demolished in the 1960s.



- 5.3.28 Each bay of the roof had 12 composite trusses dividing the 13 bays with each truss having a Polonceau form. Each truss comprised softwood (pine) members in compression (principal rafters as well as a raking struts and a vertical to each side of the truss) and steel rods acting in tension. The steel tie-rods were formed of three sections with the central section raised and further steel rods formed a triangle at the centre of each truss. Each truss included two large cast connecting members, one to each side of the truss, to link the various members. The steel bars passed through holes in the connector and the threaded ends were fixed by a bolt, while the softwood struts sat in shoes within the connectors. The connectors also fixed the ends of lateral rods which extended between trusses and which braced the building.
- 5.3.29 Malcolm Tucker (engineering historian) has written an article on the significance of this building and he notes that this style of roof is very similar to that adopted by IK Brunel for the c.1841 Goods Shed at Bristol as well as the original erecting Shop at Swindon Works (1842).
- 5.3.30 The smaller truss measured 7.45m, the collars and principal rafters 0.07m x 0.22m, the rafter chocks were 0.21m tall and the iron straps at the feet of the rafters 0.66m long. The main truss was 0.10m tall by 0.15m deep, the post was 0.10m deep by 0.15m deep, and the principal rafter 0.30m tall by 0.15m deep.
- 5.3.31 As outlined above there were two rows of secondary rooflights to each slope along the full length of the roof, other than in the end bays, but they do seem to have broadly followed the primary pattern of lights. The lower rows of lights on each of the four slopes was set at a shallower pitch than the main slope and this created a vertical step at their base where there was a vertical louvre. Evidence also suggests that the upper sets of lights formerly had a similar, shallow profile with a vertical step at the lower edge, but this was replaced by the later lights which followed the overall roof profile. This was particularly suggested by empty bolt holes to the sides of rafters close to the apex connectors which would have held tie rods similar to those which survived in the lower sets of lights. On either side of the ridge piece was a long batten or bearer with a series of empty mortices (9 in each bay), from former rafters. In the end bays the cast iron/steel apex piece is slightly taller and this raises up the ridge piece slightly in the end bay.
- 5.3.32 In the end bays there were eight purlins to each slope but in the other bays, two of the purlins were 'removed' due to the roof lights and replaced by a single purlin which extended laterally between the rows of lights.
- 5.3.33 Towards the end of both slopes in each of the two bays were diagonal cross-bracing members formed from L-profile steel, which extended across two bays (bays 2-3 and 11-12). These braces, which were probably secondary additions as they had a different character to the primary roof members, were bolted to brackets that were bolted to the principal rafters.
- 5.3.34 At the **north-western corner** of the Lifting Shop was a small Gents WC block which historic plan evidence suggests was probably added in the early or mid 1960s. A small block (almost certainly a WC) had been added by the 1952 map is shown on



subsequent maps in the 1950s but a slightly larger block is shown on the 1966 plan and this corresponds with the structure that survived at the time of the recording in 2010-11. The WC had softwood joists, sinks, urinals and WCs, the character of which was suggestive of a 1960s date. The east wall (ie the external side of the primary brick wall) was plastered so little was visible but the plastered shoulder from the formerly external plinth to this wall was visible.

- 5.3.35 There was a long section in this wall where the shoulder from the former plinth was no longer visible and this corresponded with the location of a large concrete lintel in the east face of this wall. Clearly there was formerly a substantial opening in this wall which removed the plinth. It could be that the large opening related to the c.1950 WC which was replaced in the 1960s or it could be that before the c.1950 WC was constructed there was formerly a double doorway into the building at this point. The fact that it had a concrete lintel means that the wide opening was not a primary feature however, although there does appear to have been a primary single doorway in this location. Above the wide concrete lintel there was a primary 3-brick segmental arch lintel and this was lower than the other windows (c.3.15 m above floor) suggesting it was probably a doorway. Above the segmental arch there was also a water tank relating to the WCs on the west side of the wall.
- 5.3.36 Towards the **southern edge of the building**, continuing in both the eastern and western bays, there were a series of marks or features in the floor which provided evidence relating to the former layout of this part of the building. These features clearly relate to the offices along this side of the building which were first shown on the 1966 plan (Fig 13) and were presumably constructed as part of the mid 1960s conversion of the depot.
- 5.3.37 These offices had largely been dismantled prior to the current recording although a single room did survive at the south-west corner of the building (*Plate 15a.29* and see *Fig 15a.1*). Historic plans suggest that there was a separate room at this corner from the original construction of the building (see *Gen Fig 6*) but the room that survived at the time of the 2010-11 recording was a later replacement. This room was formed from plasterboard and stud partitions (possibly even post-dating the mid 1960s works) although the evidence from the earlier layout survived. The external walls (to S and W) were of painted brick and the trace of cut-off joists from a former ceiling survived in the west wall, just below the height of the later ceiling. This room appears to have been an oil testing room with scientific cylinders, and very large test tubes, and old built-in cupboards. A manual for lubricating oil control (1992) survived in the room with a sticker saying 'OOC Oil Sampling Test room'. The south-western corner of the room was set at an angle suggestive of a former fireplace but the lower part was obscured by the cupboards (*Plate 15a.30*).
- 5.3.38 Above this room there was also evidence of a former first floor or mezzanine. This evidence included the imprint from a former partition as well as the fact that the brickwork in this former first floor room was a lot neater (less patched) than in the rest of the south wall. This room had an extant, primary 4-over-4 window in the south wall, a larger blocked opening in the west wall. This former opening in the west wall may have been a window overlooking the engine shed which formerly stood to this side of the factory. At the angled south-west corner of this room was a small fireplace from



which a small segmental arch remained visible; the upper part of this chimney (above the roofline) had been removed.

- 5.3.39 The distinct area immediately to the south of the partially surviving office had a red painted floor and the south wall was of painted brick rather than plastered. Beneath the window the wall was rendered, with the suggestion that something formerly abutted here, and clearly this appears to correspond with the evidence of the 1966 plan which shows a hose reel here rather than offices. To the east of this was a series of marks on the floor from former offices along the southern edge of the building. These largely had lino floor tiles and plastered walls although some had solid concrete floors.
- 5.3.40 Against the south wall there was a large circular imprint from a former feature c.1 – 1.25 m diameter and with a lamp directly above it (*Plate 15a.28*). This seems highly likely to have been from a clock similar to that which survived against the external wall of the Stores (Block 16). At the centre of the circle was a small square imprint which may have been from a clock mechanism.
- 5.3.41 Also at the south-western corner of the building but outside the primary footprint was a small lobby-type extension constructed from concrete block and with roller-shutters in the west wall. There was a wide opening in the primary wall (ie the east wall of the lobby) with rubber ‘flap’ type doors typical for later 20th century industrial buildings and there was an older segmental arch above (*Plate 15a.29*). This structure had a flat roof formed from softwood joists and there was a 1.25 m cantilevered concrete porch projecting by c.1.25 m from the wall, above the door opening in the primary wall. The projecting porch was secondary but it appeared to pre-date the later 20th-century lobby structure.
- 5.3.42 The main **west wall** of the hall was all of painted brick (beige to the upper half, then a white band and an aquamarine colour below c.1.5 m). The wall had several large metal vent ducts which would have carried fumes up and out of the roof (*Plate 15a.19*) as well as various pieces of electrical switchgear beneath a simple internal lean-to roof. There were also two inserted metal-framed windows (1960s) and various patches of infill from former brackets or other features. A raised doorway with ladder allowed access into 15c and much of this section of wall (c.3.25 m wide) appeared to be rebuilt. This section of wall was beneath a high RSJ and it was presumably rebuilt in the 1960s when the large boilers and tanks had to be inserted into 15c.
- 5.3.43 The main **north wall** was relatively featureless although there were a number of pipes stretching across the wall horizontally above the six ground floor windows, and two vents (*Plate 15a.18*). The elevation was painted an aquamarine colour below window height and then white above but there appeared to be several coats of a brown colour beneath the aquamarine. Towards the centre of the elevation there was a sign reading ‘*Important Lifting Tackle. Current colours are... Equipment marked with any other colour must not be used*’. At the centre of the board was a screw and several coloured boards to allow the colour to be switched over.
- 5.3.44 There was a large 50 ton **overhead gantry crane** which spanned across the eastern bay of the building and although the crane itself is known to have been secondary it



may have run of primary runners/rails (*Plate 15a.21-26*). The track appeared to be integral with the main primary structure/stanchions rather than being independent from it. Documentary research for the DDBA shows that this electrically operated crane, which was made by SH Heywood & Co Ltd of Reddish Greater Manchester, was installed in the late 1920s (ordered in Sept 1928) and it replaced an earlier 30 ton crane manufactured by Messrs Vaughan & Son. The DDBA includes some original 1928 technical drawings of the crane.

- Plate 15a.1: General view looking north-west
- Plate 15a.2: East front of Building 15a
- Plate 15a.3: East front of Building 15a
- Plate 15a.4: East elevation of Building 15a
- Plate 15a.5: North elevation of Building 15a
- Plate 15a.6: North elevation of Building 15a
- Plate 15a.7: Sill detail
- Plate 15a.8: Windows in south elevation
- Plate 15a.9: General view from south-west
- Plate 15a.10: Detail of west elevation with bearing box (hidden by plant)
- Plate 15a.11: Detail of east elevation showing former gate hinges
- Plate 15a.12: Pintle from former gate in east elevation
- Plate 15a.13: General view of interior from south-west
- Plate 15a.14: General view looking north
- Plate 15a.15: General view looking south-west
- Plate 15a.16: Truss detail
- Plate 15a.17: Trusses in west half
- Plate 15a.18: North wall
- Plate 15a.19: Northern end of west wall
- Plate 15a.20: Section of east wall
- Plate 15a.21: Crane
- Plate 15a.22: Underside of crane
- Plate 15a.23: Detail of crane
- Plate 15a.24: Detail of crane
- Plate 15a.25: Underside of crane
- Plate 15a.26: Underside of crane
- Plate 15a.27: View looking west showing fish-belly girder and clerestorey window
- Plate 15a.28: South end of Building 15a
- Plate 15a.29: South-western corner of building
- Plate 15a.30: Rooms at SW corner
- Plate 15a.31: Road looking east
- Plate 15a.32: View through from 15a into 15b

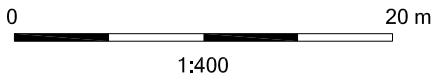
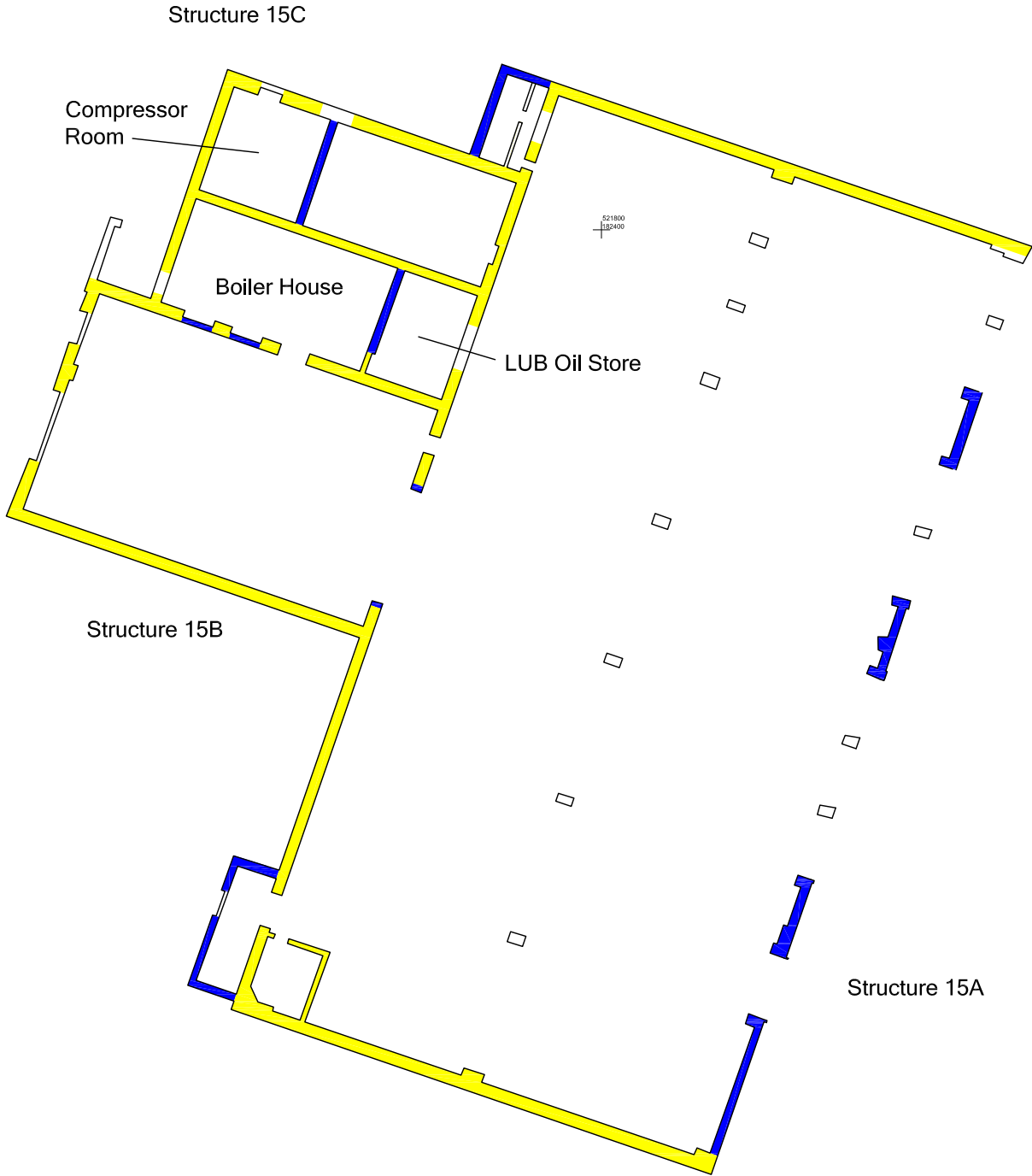

	Primary Brick Wall
	Mid 20th Century Alteration

Figure 15a.1: Building 15. Ground Floor plan

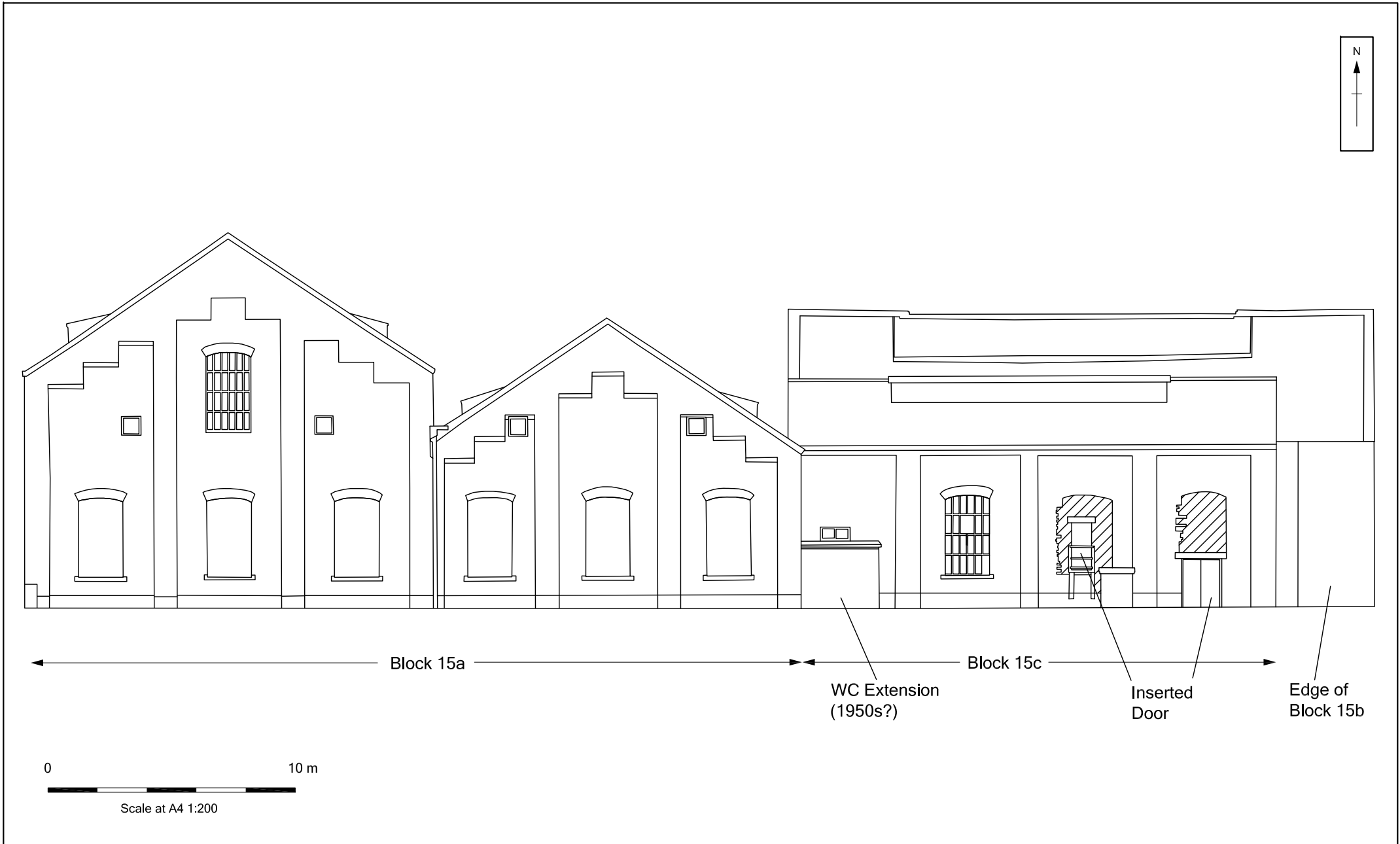

Figure 15a.2: Building 15. North Elevation

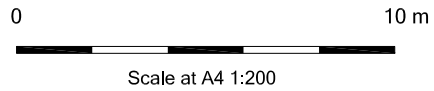
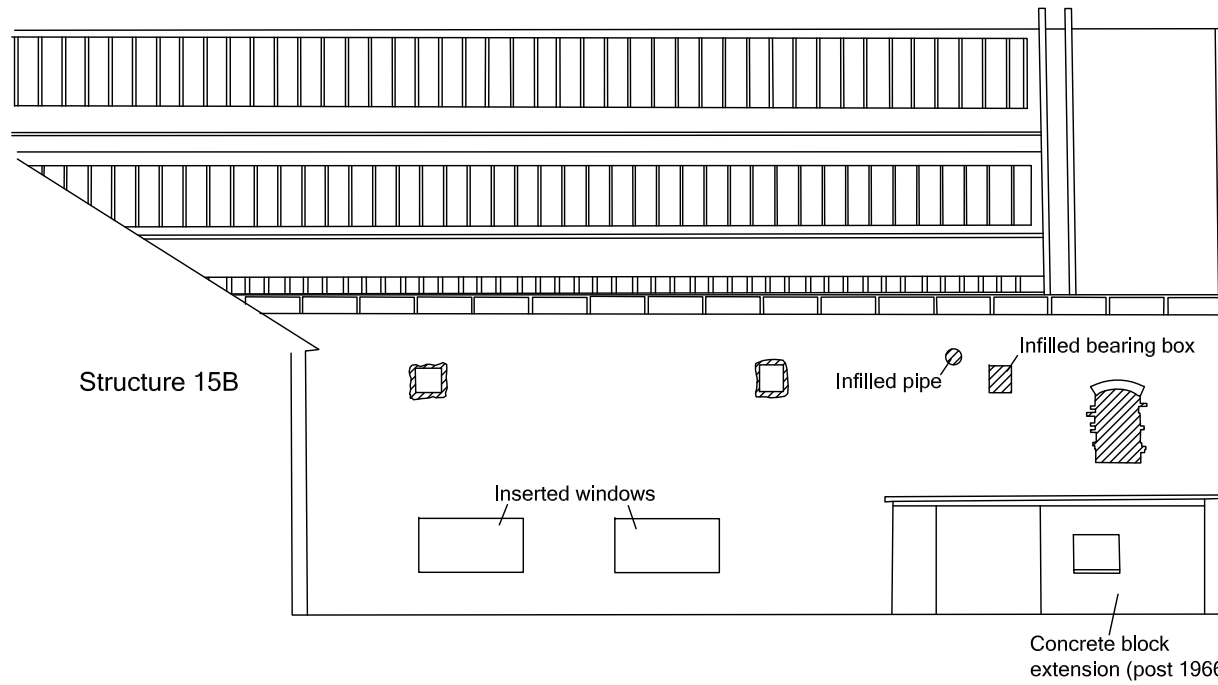
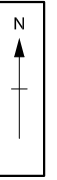
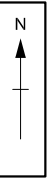

Figure 15a.3: Building 15a. West Elevation



0 10 m
Scale at A3 1:200

Figure 15a.4: Building 15a. Internal Elevation looking East



Plate 1



Plate 2



Plate 3



Plate 4



Plate 5



Plate 6



Plate 7



Plate 8



Plate 9



Plate 10



Plate 11



Plate 12



Plate 13



Plate 14



Plate 15



Plate 16



Plate 17



Plate 18



Plate 19



Plate 20



Plate 21



Plate 22



Plate 23



Plate 24



Plate 25



Plate 26



Plate 27



Plate 28



Plate 29



Plate 30



Plate 31



Plate 32



6. **STRUCTURE 15B: LIFTING BAY (PREVIOUSLY THE SMITHS SHOP)**

6.1 **Introduction and summary**

- 6.1.1 The building known as The Factory (Structure 15) was one of the key original elements of the Old Oak Common Complex and it divided into three adjoining parts: Structures 15a – 15c. By far the largest element was the Lifting Shop or Maintenance Shed (15a) while adjoining to the west of this was the Lifting Bay (former Smiths Shop, 15b) and the Boiler House (15c). The three elements have been described separately in the current report.
- 6.1.2 The Factory was located on the northern side of the main central group of buildings at Old Oak Common and it would have wrapped around the north-eastern corner of the great Engine Shed prior to the demolition of this structure in the mid 1960s. Structure 15b would have adjoined the engine shed at the very eastern end of its north elevation.
- 6.1.3 The DDBA assessed that the Factory was of regional significance. It has been recorded in the current project at EH Level 3.

6.2 **Outline History and map evidence**

- 6.2.1 Some historical information relating to the overall Factory is included above in the section on Structure 15a and is not reproduced in its entirety here. This section focuses on information relating to the former Smiths Shop (15b).
- 6.2.2 The Factory is shown on the 1906 site plan (ref: 2515-410-0062. *Gen Fig 7*) with the main building (15a) labelled as the Lifting Shop, the southern of the two western projections (15b) labelled as the Smiths Shop and the northern of the two projections (15c) split into two long east-west sections. The northern part of 15c was labelled as the Carpenters Shop and the southern part was the Coppersmith's Shop. The plan also clearly shows the engine shed that adjoined both the west side of 15a and the south side of 15b, as well as another narrow east-to-west structure which would have adjoined the north side of the engine shed and abutted the west side of Structure 15b.
- 6.2.3 Slightly more information is provided by another plan (ref: 2515-409-1516. *Gen Fig 6*) which shows that the Smiths Shop had three hearths to each side (north and south) and a double hearth at the west end. This plan was a 1959 re-drafting of an earlier damaged plan. The date of the earlier plan is not given but it appears to be the original Edwardian complex. An account of the Factory was provided in the Railway Gazette of 1 June 1906 and this confirmed that as well as the seven hearths mentioned above the Smiths Shop also contained a fan and a power hammer, 'each driven by an independent motor'. William Walkerdine of Bridge Street, Derby built the structure and was instructed to build the floor from 3" of fine ashes on top of 6" of dry ash. As elsewhere within the depot, the walls were of red brick over a plinth of blue engineering bricks and the double pitched roof was of slate.
- 6.2.4 Subsequent site plans up to the mid 1960s show little change in the Factory complex but a plan of 1966 (ref: 2515-410-2172. *Gen Fig 13*) shows various significant



changes that had been undertaken to the building as part of wider modernisation works at Old Oak Common. At this date block 15b was no longer a Smiths Shop and had had an east-to-west road extended through from the adjacent lifting shop. This part of the building is not labelled on the plan but it is known to have become a lifting bay to supplement the large Maintenance Shed that the main block (15a) had by then become. These alterations formed part of the wider works at this time to convert Old Oak Common into a diesel maintenance depot. The 1966 plan does not show a track entering the building from the west although by the time OA Ramboll investigated the building there was a track at this location.

6.3 Description

6.3.1 External Description

- 6.3.2 The former Smiths Shop was a single storey building with a rectangular plan (22.5 m x 14.3 m) and a gabled roof which was clad in secondary sheeting and which incorporated a line of lights to each slope. It was constructed from English bond red brick with blue brick sills to match the other primary buildings at the complex.
- 6.3.3 The **west elevation** was the only side of the building which would have been external from the original construction of the complex (Plate 15b.1). The north and east elevations were adjoined by other ranges of the Factory while the south elevation would have been adjoined by the engine shed prior to its demolition in the 1960s. The western gable was formed of three panels with crow-stepped inset detailing, reflecting the other primary elevations, and with the panels being separated by brick pilasters. The form of the elevation was significantly altered following the conversion of this building from the Smiths Shop to a lifting shop in the mid 1960s, through the insertion of a large opening with roller shutter doors to allow access for locomotives or wagons. The brickwork around this opening had clearly been reformed and to the south of this the wall was painted white showing that it was formerly internal. The former building which adjoined at this point would clearly have been the narrow range (WCs) which is shown on historic plans against the north wall of the engine shed. This narrow range appears to have been primary and survived until the demolition of the engine shed. There were two small patches of infill from plates relating to the former building and their location suggested that the former adjoining building may have had a clerestorey type profile. The south-western corner of the building had been reformed due to the demolition of the adjoining engine shed.
- 6.3.4 The **south elevation** of the former Smiths Shop was historically part of the internal face of the northern wall of engine shed and this is reflected by its relatively plain nature as well as by the fact that it is covered by a white paint (Plate 15b.3). Much of the paint had worn away but more survived beneath the eaves. The wall was constructed from red English bond brick and there were four boarded windows at ground floor with concrete lintels. These windows were 20th-century insertions (detailed further below) and the jambs/lintels/sills had clearly been reformed. There were several patches of apparent rebuild, just below the eaves, and these may indicate the location of former trusses from the engine shed. The paint obscured these patches somewhat but it appeared that the wall would have had six trusses entering it, with the eastern most one



6.3.5 *Internal Description*

- 6.3.6 The interior of the former Smiths Shop was a single room, open to the roof, and the east wall had been largely removed to essentially unite this space with the main adjacent lifting shop (Block 15a). The opening had a pair of I-section joists above it and the jambs had been reformed suggesting that the opening was a secondary creation (probably removed in the 1960s alterations to convert the Smiths Shop into a Lifting Bay). Protective plates, c.1.25 m tall, had been fixed to the corners of this opening, presumably to guard against small trucks moving between the buildings. Also in this east wall of the Block 15b, to the north of the large opening, there was a smaller doorway for pedestrian access beneath a primary segmental arch (*Plate 15b.4*). There was no door in-situ within this opening and no imprint from a former frame to the jambs to suggest that it was ever closed.
- 6.3.7 The 1960s conversion works also included the extension of an inspection pit and a set of tracks from the main Factory building (Maintenance shop).
- 6.3.8 Either side of the inspection pit in Block 15b were four sets of red lifting jacks (8 in total) set on a small set of simple tracks (75 cm apart) set in the ground to allow them to be moved east and west parallel with the main inspection pit extension (*Plate 15b.9 - 11*). Each jack had a small electrical motor and a very tall vertical screw/rod which would rotate to slowly raise or lower the main support brackets. The support bracket could also be moved sideways by a hand screw/wheel. The character of the lifting jacks was suggestive of a 1960s date so they may have dated from the conversion of the building from the Smiths Shop to the Lifting Bay. The jacks were made by Matterson Ltd of Rochdale and they had a plate with ME8116 SWL 25 tons.
- 6.3.9 There were seven steps at the west end of the inspection pit to allow access and five fluorescent lights set in each vertical face of the pit which could be swivelled to illuminate the underside of the train.
- 6.3.10 At the time of the OA Ramboll recording in 2010-11 the east-to-west road continued through the lifting bay and out of the building through a roller-shutter door in the west elevation. The internal jambs around the opening had been reformed and the nature of new brickwork was suggestive of a relatively recent alteration (eg last quarter of the 20th century). In addition a site plan from 1966 does not show the tracks exiting through the west wall and thus the inserted door probably post-dated this. Also in the west wall, to the north of the large roller-shutter doors was another smaller opening for pedestrian access, again with roller shutters, and this appeared to be from the same date as the larger opening (*Plate 15b.5*). As referred to in the external description there is a segmental arch above this doorway which was probably from a blocked window in this location.
- 6.3.11 The walls of the lifting bay were painted white up to c.2m above the floor and a very light brown/beige above this. The jambs of the main inserted door in the west wall were unpainted above the c.2m line and at this point it was possible to see a number of former layers of paint. There appeared to be at least six distinct paint layers with a light blue forming the base layer, then several layers of white on top of this and then a further coat of light blue before the beige upper layer.



- 6.3.12 The south wall had four inserted, metal-framed, mid 20th-century windows with concrete lintels, tiled sills and frosted glass. The windows had a single large pane and they were horizontally hung casements with a central pivot to open like a hopper. The south wall also had four large lights fixed to it and two ducts/vents.
- 6.3.13 The room retained little evidence relating to its historic use as a smiths shop but it did retain various features relating to its later use as a lifting bay. Towards the south end of the lifting bay was a control panel set on a concrete plinth from where the jacks would have been controlled. The structure incorporated electrical gear and eight 'on-off' buttons (presumably one for each jack) all set in a cabinet by 'verity's Switchgear, Aston, Birmingham'. On the wall there was also a box with 'chloride spegel charger' written on it and with switches inside aswell as an amp meter dial/gauge.
- 6.3.14 The main feature of the north wall were three large primary openings between Block 15b and the adjacent Block 15c (*Plate 15b.7-8*). Each was beneath a concrete lintel and while the two westernmost openings had been blocked by a simple wood frame, the easternmost one remained open, albeit with a secondary doorway inserted.
- 6.3.15 Against the north wall of 15b were fixed two large heaters, apparently connected to water pipes and towards the east end there was a free-standing grinding machine, apparently for sharpening tools with rotating stones (1960s?).
- 6.3.16 The **Roof** of Block 15b was divided into five bays by four primary Polonceau-type trusses very similar to those in the main block (15a). The underside of the roof was clad in tongue-and-groove boarding and although the roof had been recovered the main structure appeared largely primary (*Plate 15b.6*).
- 6.3.17 Each of the trusses comprised softwood (pine) members in compression (principal rafters as well as a raking struts and a vertical to each side of the truss) and steel rods acting in tension. The steel tie-rods were formed of three sections with the central section raised and further steel rods formed a triangle at the centre of each truss. Each truss included two large cast connecting members, one to each side of the truss, to link the various members. The steel bars passed through holes in the connector and the threaded ends were fixed by a bolt, while the softwood struts sat in shoes within the connectors. The connectors also fixed the ends of lateral rods which extended between trusses and which braced the building.
- 6.3.18 As mentioned above in the external description the roof had a long row of secondary roof lights towards the top of each slope but most of these were blocked when the recording was undertaken in 2010-11 so the interior was quite dark. However, evidence from an arrangement of former roof lights was visible, partly from patches of slightly different types of tongue and groove boarding which was used to clad the underside of the roof. The location of the former roof lights were also apparent through battens and boards fixed to the purlins which would have supported the former windows. They appear to have been simple lights following the slope of the roof rather than incorporating vents.
- 6.3.19 The roof comprised five bays and there appears to have been a window in each of the inner three bays to each slope. The windows were two purlins tall (extending



between the lowest and the third purlin). The key evidence was a slot cut in the 2nd lowest purlin, where the purlin would have passed through, visible on both slopes in each of the three bays. The upper faces of these slots was hidden by a long secondary rail, probably added to allow the secondary tongue and groove boarding to be added. Also, on the south slope there was a board, c.75 cm long, on the upper side of the lower purlin at the centre of each of the three inner bays. And directly above this board was a patch of distinct (secondary) tongue and groove boarding. There was also a small rooflight in the eastern bay of the south slope, possibly a secondary insertion, between the lowest and the second lowest purlin.

- 6.3.20 In the end bays there were eight softwood purlins and a ridge piece, with each purlin supported by a triangular shaped block on the back of each rafter. The lower six purlins continued through but the upper two purlins in the end bays are 'replaced' in the inner bays by an intermediate purlin with the secondary skylights both above and below this. The intermediate purlin was also supported by a block on the back of each rafter but this block was raised slightly above the rafter.
- 6.3.21 On each side of each principal rafter in the end bays there were metal straps bolted to the rafters which would presumably have supported a feature but each of these had been truncated when the recording was undertaken in 2010-11. There were also corresponding holes in the sides of all the other rafters which strongly suggest that there would formerly have been similar straps to every rafter. Evidence suggests that these related to an earlier set of roof lights which were set at a shallower pitch than that of the main roof. Similar shallow pitch roof lights survived in-situ at the time of the 2010-11 recording in the main Factory building (15a) with a vertical step along their lower edge.
- 6.3.22 The roof incorporated two longitudinal ties extending between trusses but the southern one was no longer in-situ at the west end (between western truss and gable wall).

Structure 15b Plates

- Plate 15b.1: West elevation of Structures 15b and 15c
- Plate 15b.2: West elevation of 15b
- Plate 15b.3: South elevation of 15b
- Plate 15b.4: Interior of 15b looking east
- Plate 15b.5: Interior looking towards west wall
- Plate 15b.6: Roof inside 15b looking east
- Plate 15b.7: Door from 15b to 15c
- Plate 15b.8: North wall of 15b shared with 15c
- Plate 15b.9: View west in 15b
- Plate 15b.10: Jacks in 15b
- Plate 15b.11: Jacks in 15b.



Plate 1



Plate 2



Plate 3



Plate 4



Plate 5



Plate 6



Plate 7



Plate 8



Plate 9

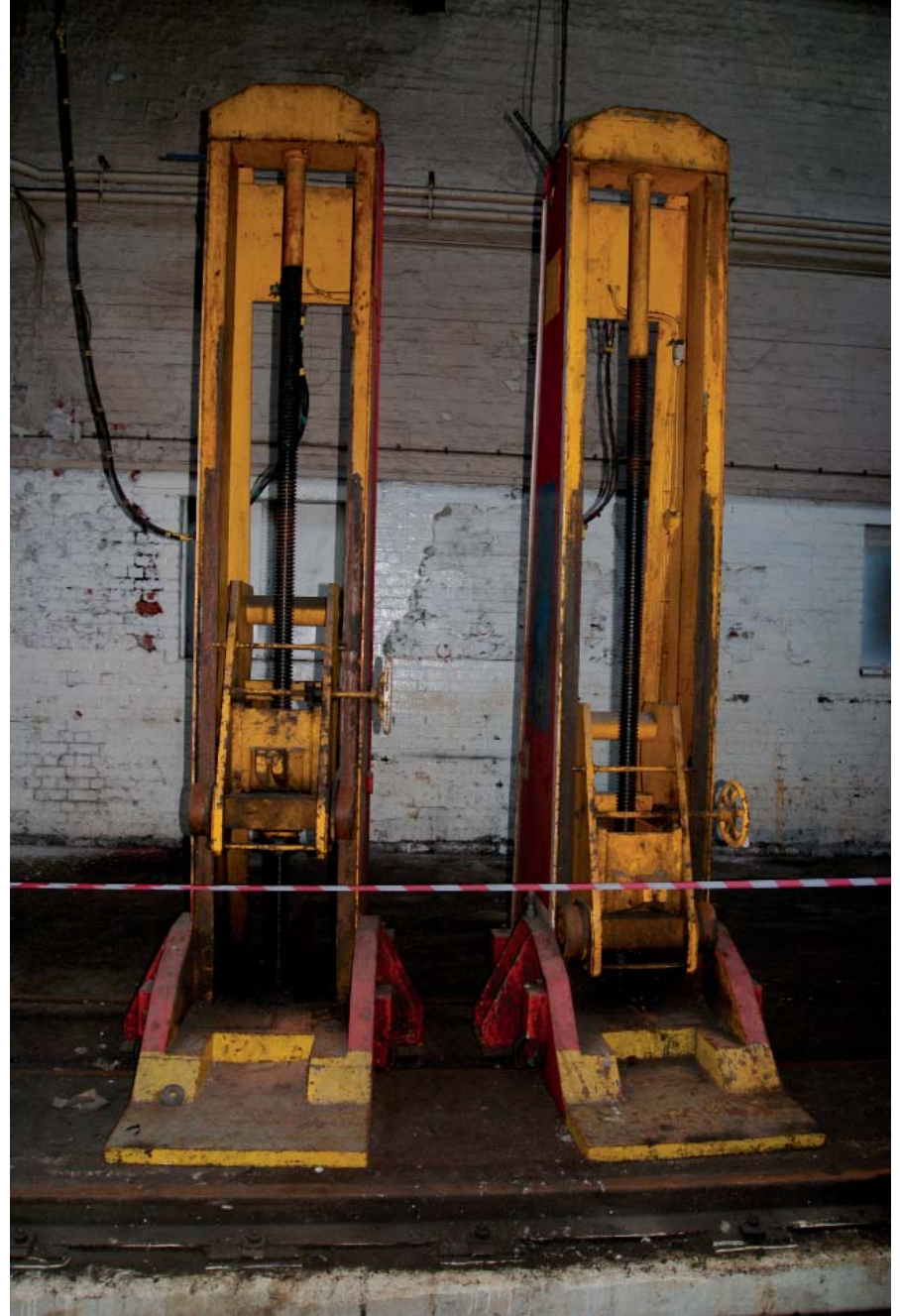

Plate 10



Plate 11



7. **STRUCTURE 15C: BOILER HOUSE, COMPRESSOR HOUSE, LUBRICATION AND WASTE OIL TANKS, PREVIOUSLY THE COPPERSMITH'S SHOP AND CARPENTER'S SHOP**

7.1 **Introduction and summary**

- 7.1.1 The building known as The Factory (Structure 15) was one of the key original elements of the Old Oak Common Complex and it divided into three adjoining parts: Structures 15a – 15c. By far the largest element was the Lifting Shop or Maintenance Shed (15a) while adjoining to the west of this was the Lifting Bay (former Smiths Shop, 15b) and the Boiler House (15c). The three elements have been described separately in the current report.
- 7.1.2 The Factory was located on the northern side of the main central group of buildings at Old Oak Common and it would have wrapped around the north-eastern corner of the great Engine Shed prior to the demolition of this structure in the mid 1960s.
- 7.1.3 The DDBA assessed that the Factory was of regional significance. It has been recorded in the current project at EH Level 3.

7.2 **Outline History and map evidence**

- 7.2.1 Some historical information relating to the overall Factory is included above in the section of Structure 15a and is not reproduced in its entirety here. This section focuses on information relating to the former Carpenter's and Smiths Shops (15c).
- 7.2.2 The Factory is shown on the 1906 site plan (Ref: 2515-410-0062. *Gen Fig 7*) with the main building (15a) labelled as the Lifting Shop, the southern of the two western projections (15b) labelled as the Smiths Shop and the northern of the two projections (15c) split into two long east-west sections. The northern part of 15c was labelled as the Carpenters Shop and the southern part was the Coppersmith's Shop.
- 7.2.3 Subsequent site plans up to the mid 1960s show little change in the Factory complex although one minor addition, first shown on a plan of 1952, is the construction of a small extension at the northern end of the west side of Structure 15a. This would also have adjoined the north side of Structure 15c and although it is unlabelled on this drawing later plans show it to have been a WC block. It is not shown on a plan of 1949 (*Gen Fig 11*).
- 7.2.4 A plan of 1966 (ref: 2515-410-2172. *Gen Fig 13*) shows various significant changes that had been undertaken to the building as part of wider modernisation works at Old Oak Common. This plan shows a compressor room in the west part of the former carpenter's Shop (ie N half of 15c) and a boiler house and lube oil room in the former coppersmiths Shop (S half of 15c). The projecting block at the northern end of the west elevation is labelled on this plan as a WC.



7.3 Description

7.3.1 External Description

7.3.2 Block 15c was located at the north-western corner of the Factory and was a rectangular plan structure (19 x 15 m) with a double-gabled roof covered in secondary, light-weight cladding and incorporating long roof lights to each slope. Only the north and west elevations were ever visible externally due to the other sides of the building adjoining Blocks 15a and 15b. The structure was constructed from red brick laid in English bond and it shared similar detailing to the rest of the Factory.

7.3.3 The **north elevation** faced onto a set of railway tracks which wrapped around this edge of the site and a bank beyond that (*Plate 15c.2*). The elevation divided into four bays with simple recessed panels divided by full height piers and with a blue-brick plinth. There would originally have been a large, 24 light window in each of the four bays but only one of the windows remained in-situ at the time of the 2010-11 recording. The surviving window was in the second bay from the east and had four rows of six lights beneath a 3-brick segmental arch. The outline of similar bricked up openings were visible in the other three bays and each had also seen other alterations. The western bay had had double doors inserted, largely beneath the bricked up window, and with a concrete lintel. The adjacent bay to the east had had a raised single doorway inserted with a concrete lintel and a simple metal ladder up to a platform at the height of the doorway. The eastern bay of this elevation was abutted by a small single storey brick-built WC (*Plate 15c.3*) which is first shown on the 1952 plan. To pipes and valves entered the building beneath the in-situ window and there was a small motor and pump adjacent.

7.3.4 The **west elevation** shared the general constructional form and architectural detailing as the other external elevations (*Plate 15c.1*). It had a pair of matching gables with crows-step detailing in the brickwork and a central, secondary ladder between the gables, to allow access to the roof valley from the ground. It appears that each bay would have been a mirror image of each other with a large 24-light window towards the outer edge of each bay alongside a pair of doorways close to the central line. However, both doorways had been bricked up prior to the recording in 2010-11 (probably infilled in the mid 1960s alterations) and similarly the window in the southern gable had also been infilled. Only the window in the northern gable remained and this had seen some modification to insert a casement towards the centre.

7.3.5 Internal description

7.3.6 The interior of Block 15c divided into two long, similarly sized east-to-west sections and although the building has been much altered this arrangement reflected the primary layout (see Fig 15a.1). As detailed above in the historical background the northern half was originally the Carpenter's Shop while the southern half was the Coppersmith's Shop. However, in the 1960s the Carpenter's Shop was divided into two unequally sized rooms (compressor Room to west and larger unlabelled room to east) and the former Coppersmith's Shop was divided into a Boiler House to west and a small Lube Oil store to east. This basic layout of rooms remained until the demolition of the building in 2011.



- 7.3.7 The larger room in the south half of Block 15c was the Boiler House and at the east end of this room there were pumps to pump hot water (*Plate 15c.5*). The walls were of brick painted blue to the lower 2 m and white above this (with much of the paint flaking off) and the room had large hood lamps suspended from the trusses (*Plate 15c.8*).
- 7.3.8 This room was dominated by three large horizontal, cylindrical **boilers** which almost certainly survived from the 1960s conversion works (*Plate 15c.7*). The three boiler tanks, which appeared to be identical to each other, had insulating covers and they were set on RSJs on the floor. They each had temperature/pressure gauges at the south end and the eastern tank had a plate reading FM8916SWL3CWT. Pipes extended out of the top of the tanks to connect with the wider network and over these there was a suspended raised metal walkway which was also from the 1960s works (*Plate 15c.8*). This walkway was reached by a tubular metal staircase at the east end. There were drainage/service ducts in the floor of this room and a large metal duct above the three tanks extending out of the west wall.
- 7.3.9 At the east end of the boiler house there was a mid-height concrete block wall which created a lube oil storage area.
- 7.3.10 In the west wall of the boiler house there was a secondary inserted doorway with a concrete lintel and slat vent double doors but there was also evidence of two former primary openings: a doorway towards the north and a window towards the south (immediately above inserted door).
- 7.3.11 The **roof** in the boiler house comprised four primary composite roof trusses, approximately half the length as those in 15a and 15b, supporting three main softwood purlins set on the backs of principal rafters and supported by triangular shaped softwood blocks. Each truss included a timber principal rafter and collar as well as a cast iron (or steel) connecting shoe at the apex which secured the upper end of a vertical 'king bolt'. This bolt continued down through the collar where it was fixed to another smaller cast iron connecting piece. This connecting member also fixed the upper ends of two inclined tie-rods, which each continued down towards the eaves and were fixed with bolted straps to the sides of the principal rafters. The principal rafters enter the walls c.3 brick courses below the wall tops.
- 7.3.12 In the trusses there were also simple bolts in the underside of the collars which extended up through the principal rafters and into the central purlin to tie these members together. On the south slope there are small pulley wheels fixed to the upper face of the lower purlin in bays 2, 3 and 4. These presumably operated casements in the roof lights.
- 7.3.13 Similarly to Block 15b the roof incorporated roof lights to Bays 2, 3 and 4 (ie not the end bays) and just to the upper halves of each slope. The glazing was clearly secondary wired glass but the openings also appeared to be secondary insertions. This was partly suggested by the fact that the uppermost purlins appeared to be cut to allow for the roof lights and by the fact that the tongue and groove board ceiling wasn't edged or finished at the point where it met the light. This rough appearance of this point suggested that further boards had been removed.



- 7.3.14 The former Carpenter's Shop in the north half of Block 15c was divided from the former Coppersmith's Shop by a primary brick wall and the only access between these two spaces was via a raised doorway. The former Carpenter's Shop was divided into two spaces by a cross-wall that brick for its lower half and concrete block to its upper half, although the full height of this wall was only half the height of the room (*Plate 15c.15*). At the time of the recording there was no access into the smaller west room (compressor room) but the east room had three tall, metal, vertical cylindrical tanks with various pipes connecting the tanks and three further concrete bases towards the south-west corner from former plant (*Plate 15c.13*). They were presumably oil tanks and each was formed from three metal bands welded together. This area had a walkway, similar to that in the former Coppersmith's Shop, over the tops of the tanks.
- 7.3.15 There was a blocked door in the east wall, just to the west of the centre of the wall, which was almost certainly a primary door between the lifting shop and the Carpenter's House. This had a segmental arch and stop-bullnose jambs. In the north wall there was a primary metal-framed window (6 x 4 lights) with bullnose sill and at the west end of the north wall there was a raised doorway beneath a bricked-up arch.
- 7.3.16 The **roof** in the former Carpenter's Shop was essentially the same as that in the south half of Building 15c but the rooflights were slightly different (*Plate 15c.9*). In this section the ridge piece continued right along the building and there were simple roof lights along both slopes in Bays 2, 3 and 4. Again there was an awkward junction between the roof lights and the tongue-and-groove boarding. Those lights to the east side were corrugated translucent perspex but those to the west were similar to those in the Boiler House (probably 1960s). There was some evidence of alteration to the roof in the form of seven empty mortices from former rafters, within a rail directly on top of the upper purlin in the north slope. This plate was above the line of tongue-and-groove boards and it would be indicative of a different arrangement of roof lights.

Structure 15c Plates

- Plate 15c.1: West elevation
- Plate 15c.2: Part of north elevation
- Plate 15c.3: Eastern part of north elevation
- Plate 15c.4: Interior: shared wall with 15b
- Plate 15c.5: East end of boiler house
- Plate 15c.6: East end of boiler house
- Plate 15c.7: General view looking west in boiler house
- Plate 15c.8: Raised gantry in boiler house
- Plate 15c.9: Roof in former Coppersmiths Shop
- Plate 15c.10: East end of boiler house structure
- Plate 15c.11: Pulley wheel, possibly from former roof light
- Plate 15c.12: Roof in boiler house
- Plate 15c.13: Former coppersmith's shop.
- Plate 15c.14: West end of former coppersmiths shop
- Plate 15c.15: Wall dividing former coppersmiths shop.



Non-listed Built Heritage Recording at Old Oak Common, Acton Event Code XSU10
C254-OXF-T1-RGN-CRG05-50001rev2



Plate 1



Plate 2



Plate 3



Plate 4



Plate 5



Plate 6



Plate 7



Plate 8



Plate 9



Plate 10



Plate 11



Plate 12



Plate 13



Plate 14



Plate 15



8. STRUCTURE 16: THE STORES

8.1 Introduction and summary

- 8.1.1 The stores building was one of the key buildings that survived from Churchward's original 1904-6 Old Oak Common complex. It lay centrally within the yard and had formerly been attached to the centre of the eastern elevation of the Engine Shed, prior to the demolition of that structure in 1964. Structure 15 (The Factory) lay to the north and the Amenity Block (Building 17) lay to the south. It was formed by two identically-sized blocks beside one another and on modern site plans these are labelled as 16a and 16b but in the current report it makes sense to consider the overall structure as a single building with a single description.
- 8.1.2 The DDBA considered this building to be of regional significance. It has been recorded in the current project at EH Level 3.

8.2 History and map evidence

- 8.2.1 The building is first shown on the site plan of 1906 (Gen Fig 7) with a large central open-plan stores area and various rooms along the north and south sides of the building. The section along the northern wall comprised two rooms (Cleaners Store to west and Enginemen's Messroom to east) while the southern end of the building was divided into three rooms (Enginemen's Room, Clerks and Foreman) as well as a full width corridor across the building. In addition, there were two further unlabelled rooms at the south-east corner of the open stores area. It is interesting to note that this plan is very similar to the general arrangement that survived at the time of the recording in 2010-11.
- 8.2.2 Further useful information on the early form of the building is provided by a plan (ref: 2515-409-1516. *Gen Fig 6*) which was a 1959 re-drawn copy of an earlier damaged plan and although the date of the original is not given it appears to show the primary Edwardian complex. This plan, which shows detail such as the location of fireplaces and staircases, indicates that the Enginemen's Mess Room had a 6 ft cooking range at its west end and that the two rooms at the south-east corner of the open-plan Stores area were a Stores Office and a room for 'call boys'. Each of these two rooms had a small fireplace in the shared central wall. Most of the fireplaces in the building had register grates but at the south-west corner of the stores there was a hob grate.
- 8.2.3 The building is shown with the same layout and the same function to the rooms on a plan from 1938 (*Gen Fig 9*) although a plan of 1941 shows that by this date the Foreman's office at the south-east corner of the building had been extended to the west to include what was formerly the Clerk's office. There are several other site plans from the 1940s and early 1950s which suggest little change to the building but a plan from 1958 gives some more information on the use of the rooms. The northern rooms are still shown as in 1906 with an enginemen's messroom and cleaners store but the two rooms at the south-eastern corner of the open-stores area are shown to have been a Stores Office and a Shift Foreman's room. The same plan shows the rooms to the south of the corridor as being an Enginemen's Lobby (to west), a time



office (to centre) and a Clerks room (to east). In addition, by 1958 a small extension had been constructed at the east end of the south elevation which was for the Head Foreman. Another longer but narrower extension had also been added towards the centre of the south elevation although the function of this is not shown.

- 8.2.4 A plan of 1966 (*Gen Fig 13*) shows that by this date the former Enginemen's Mess Room at the north-east of the complex had been converted to Filter Cleaning Plant although the room to the east of this was still the 'Clean Room'. The plan labels the whole southern part of the building as 'Offices'. This is the first plan which shows the complex following the demolition of the Engine Shed and it shows a long structure (presumably a covered walkway) against the west wall of the Stores building which had formerly adjoined the engine shed.

8.3 Description

8.3.1 External description

- 8.3.2 Structure 16 was a large, two-storey brick building with a rectangular plan (23.5 x 37.25 m) orientated north to south. It was constructed of English-bond red brick with a plinth formed from dark blue bricks and a slate covered roof which had an M-profile with double gables to east and west.

- 8.3.3 The **south elevation** of Structure 16 was relatively plain consisting of six bays created by piers and panels inset by the width of a header (*Plate 16.4*). The lower half of the south elevation had been rendered for its full width and presumably this reflects the fact that several extensions were added along this wall (first shown on 1958 map). The bay to the east of the centre line had a secondary inserted doorway and the other five bays had relatively squat windows which were all secondary insertions (although they were boarded on the outer face). It appears that five of the bays would originally have had taller windows similar to those in the east face and the crest of segmental brick arches could be seen projecting just above the render line. However, it appeared that the segmental arch in the second bay from the west was wider than the others (although they were only partially visible).

- 8.3.4 The **east elevation** comprised of two large gables, each with crow's feet detailing and each with three bays divided by piers (*Plates 16.1, 16.3*). The elevation survived in relatively unaltered form and was dominated by two vast 24-light windows set high in the central panel of each gable. The northern gable had a primary door in the central panel, above which there was a segmental arch and through which a single track had originally entered the building for trains to unload stores. This door had been bricked up and a much smaller goods door inserted, beside which there was an even smaller pedestrian doorway. There were concrete lintels over both, and a roller shutter in the goods entrance. A small, modern steel sign between them read '*Stores Enquiries*'.

- 8.3.5 In keeping with the symmetrical nature of this elevation, both gables had had four original windows at ground floor level, each with segmental arches and sloped brick sills, and represented in pairs in the outer panels of each gable. However, the northern two windows of the northern gable had been infilled and replaced with a roller shutter door beneath a concrete lintel, and with a concrete ramp. Curiously, the segmental arch of the northernmost of these windows had also been replaced,



perhaps because it had collapsed when the alterations were taking place (*Plate 16.7*). A very faded sign to the right of the doorway read 'Stop-Look-Listen Beware of Locomotives'. Just above mid height in the eastern and central panels of the northern gables there was a line of nine tie-bar plates. These had been inserted, possibly to support an internal structure. The primary upper windows had opening four-light centres and metal frames. The southern gable differed from the northern gable by featuring two pedestrian doorways in the central panel rather than a train portal. The southern doorway had a slightly higher segmental arch but both doorways appeared primary. A huge clock sat above the upper window of the southern gable (*Plate 16.13*), and there was also a modern window inserted jarringly in the southern panel of this gable at high level.

- 8.3.6 The **west elevation** was formed of two large, relatively featureless gables (*Plate 16.6, 16.12*), of very different character to the eastern elevation reflecting the fact that this side of the building formerly adjoined the great engine shed prior to its demolition in the mid 1960s. This was clearly not originally an external face, a fact made apparent by the lack of decorative features, the fact that it was not smoke blackened (unlike the other walls) and by the patches of a former white paint to a height of three-quarters the way up the elevation. There was no clear horizontal line or evidence for a lead flashing line to the top of the adjoining structure. Historic photographs show that the roof of the former adjacent engine shed continued the profile and line of the Stores building.
- 8.3.7 The main features in the elevation were a pair of very large 24-light windows (one in each gable), to match those in the east elevation although the window in the southern gable was very noticeably off-centre. This is a feature that occurs regularly in primary buildings throughout the yard. The elevation had numerous small infilled patches and infilled pipes.
- 8.3.8 A covered walk-way for pedestrians was added along the base of the elevation after the demolition of the engine shed and this enclosed various features (*Plate 16.15, 16.16*). In the northern half of the elevation there were two segmental arches, the heads of which protruded above the walkway. An EWS sign described this as the 'Safe Walking Route'. Inside the walkway there was another walkway, now infilled and the head for which was slightly lower. The doorways in this half of the elevation were all secondary and had concrete lintels. In the southern half of the elevation there was a primary doorway with a segmental arch, bullnose bricks, and special bricks 2m above ground level to effect the change between the bullnose and straight bricks. To the right of this doorway was a steel sign which read 'Team Leaders Office Rest Room Gents Toilet'. There was another segmental arch in this half of the wall, below which a roller shutter door had been inserted. At the south end of the elevation there were two boarded windows of the same modern age as those in the south elevation.
- 8.3.9 Within the walkway the primary wall was painted with a distinctive colour scheme of white over mulberry, separated by a thick band of yellow. This is continued on the light partition that formed the lower half of the southern wall of the walkway, above which were four light horizontal windows. The walkway roof was formed of softwood rafters which supported clear corrugated sheets.



8.3.10 The **northern elevation** was the least altered wall of the building (*Plate 16.1*). It was formed from six bays, of large bricks (7.75 cms x 23 cms x 10.5 cms) in English Bond adjusted in places to accommodate the width of the panels. All panels except the southernmost had windows with segmental arches and blue brick sills formed of very large sill bricks (15 cms width). Plinths of blue bricks with sloped shoulders formed the base of each panel (*Plate 16.14*). The very western edge of the elevation had been reformed with bricks of a different colour in order to repair the damage caused by the removal of the engine shed in 1963. The rainwater goods were of cast iron, and retained the original hoppers. An inserted water pipe and an industrial tap protruded from the centre of the elevation, just above the height of the window sills. Each pier has three indented bricks, possibly to hold pipes or services. This elevation was very smoke-blackened, except curiously, for two of the three panels in the eastern half. The plinth carried a bitumen damp-proof course just above ground level. The easternmost panel contained a door rather than a window. The segmental arch was set at the same height as the arches for the windows, meaning that there was a blank brick panel above the door, which was a primary opening but had a modern door and a concrete lintel. The windows were of attractive timber 'eight over eight' sashes with finger recesses on the lower bar to allow the sash to be slid up. Internally, there were plain timber sills with simple moulded architraves. All had been painted white.

8.3.11 *Internal description*

8.3.12 The Stores building appears to have essentially remained in its primary function throughout its life and the layout of the building in its final incarnation (when recorded in 2010) was very similar to that shown on the earliest historical plans. The interior comprised a very large central hall (21 x 17.5 m) which was open to the roof and would have formed the main storage space, with smaller blocks of rooms to the north and south as well as a smaller group of rooms at the south-east corner of the hall.

8.3.13 The **central hall** was a vast empty space when the recording was undertaken and although this was visually impressive it no doubt provided a false impression of how this store building would have appeared for most of its history.

8.3.14 The most striking element of the hall was the **roof** which was visible from the ground and close inspection of this structure could be made from the mezzanines around the hall. The roof had an M-profile with two identical east-to-west bays, each one with sets of, north-to-south Polonceau-type trusses.

8.3.15 The trusses were of composite construction with softwood (pine) members in compression (principal rafters as well as a raking struts and a vertical to each side of the truss) steel rods acting in tension. The steel tie-rods were formed of three sections with the central section raised and further steel rods formed a triangle at the centre of each truss. Each truss included two large cast connecting members, one to each side of the truss, to link the various members (*Plate 16.31, 16.36*). The steel bars passed through holes in the connector and the threaded ends were fixed by a bolt, while the softwood struts sat in shoes within the connectors. The connectors also fixed the ends of lateral rods which extended between trusses and which braced the building.



- 8.3.16 The trusses were of structural interest in their own right, particularly the unusual connecting pieces, but they are also of interest because it is known that the engine shed had similar trusses prior to its demolition in 1964-5. There are various historical photographs showing trusses in the engine shed with similar connectors that survived in Structure 16 and there also survives an original engineers drawing detailing the trusses of the engine shed roof (Gen Fig 14). These are essentially the same as those from the Stores building. The drawing confirms that the bars in the trusses were formed from mild steel (working in tension) and the rafters were of pitch pine. The drawing does not specify whether the connectors were of cast iron or cast steel but there is a note to show that the same trusses were also used at Small Heath (in 1905).
- 8.3.17 The east-to-west spine at the centre of the building comprised a steel composite beam which supported one end of each truss and latticework bracing which hung down from the beam (*Plate 16.25*). This loadspreading bracing would have been relatively advanced when it was constructed in c.1903-6. The spine beam was supported at its midpoint by a cylindrical central, cast-iron column which also acted as a downpipe for the gutter in the central valley and was one of the most interesting features of the building (*Plate 16.28*). This column was stamped 'GWR W'hampton Dec 1903' and carried a giant head.
- 8.3.18 There were two large rooflights to each slope – one immediately below the ridge piece and a second further down. The lower lights were secondary – the purlins being truncated to allow for their insertion and the current arrangement does not match as it would have done if all had been primary. There were nine purlins to each slope, not including the ridge piece, and each was held to the rafter by a triangular-shaped wooden block – there were no apparent fixings. The upper rooflights were supported by an extra purlin which did not extend beyond the edges of the windows and had a 'Z'-shaped scarf joint. The scarfs on the genuine purlins, just above the principal rafters, was much less clear (it looked like a narrow notch taken out and then infilled).
- 8.3.19 The roof structure also contained clear evidence of a former system of vents and/or an earlier set of rooflights. On all pitches there were pairs of bolts through each principal rafter at c.1m below the ridge and just below the fourth purlin. Each bolt was c.0.2m apart and had fixed a tie-bar to the principal rafter. The tie-bars had gone, leaving either the bolts only or a complete bolt end that had remained when the rest of the bar had been sheared off. The bars would almost certainly have helped keep in a vertical position the louvred vents that are shown on photographs of the building from the 1950s and earlier and had been replaced by the lower row of rooflights. The bolts only appear on the inner three pairs of trusses. Another interesting feature were the c.0.6m long blocks of shaped wood which were attached to the principal rafters below the upper row of rooflights. These had presumably served a function in the support or mechanised operation of the features which the rooflights had replaced.
- 8.3.20 The southern wall of the hall was blank except for a flight of open timber treads leading to the mezzanine level above the block (the underside of these steps had later been boarded off). The iron balusters were widely spaced, at c. 0.90m apart, and carried a timber handrail (*Plate 16.17*). A set of stairs is shown at this location on the early plan and there seems little reason to doubt that it was a primary feature. Below



this flight was a fire door below a concrete lintel. A magnetic display board by the bottom of the steps was divided vertically between different classes of locomotives, and magnetic part numbers were stuck in columns below the name of each class. Beside this board was a sign reminding staff that *'Recharged fire extinguishers are stock item (sic) to be booked off'*.

- 8.3.21 The internal western wall of the building provides a few clues for the external arrangement of details. The reason for the offset window in the southern half of the gable was for it to avoid a chimney stack that vented a fireplace in the angle between the gable and the north wall of the southern mezzanine block (ie at the south-west corner of the hall). The join between the flue and the fireplace was achieved by the rising stepped arrangement seen elsewhere across the yard. The stack rose to just south of the apex of the roof. A fireplace (labelled *Hob Grate*) is shown in this location on the early plan of the building although it had been bricked up, possibly in the 1960s alterations.
- 8.3.22 A second chimney rose to meet the valley between the two halves of the building. This had a blocked hearth illustrated by a small segmental arch beneath which was a ventilation grille. Again a small fireplace is shown at this location on the early plan.
- 8.3.23 Three segmental arches in the western gable were visible from the floor of the main bay, including a large arch above the roller shutter doors that suggests there was once a large goods entrance at this point. Another sat above a modern pedestrian entrance in the northern half of the gable. Otherwise, the internal face of the gable, which had been painted white, was characterised by a network of water pipes, electrical conduits, ventilation ducts, cables, electrical switchgear and modern signage.
- 8.3.24 At the north-western corner of the hall was a flight of steps that provided access to the northern mezzanine but this set of galvanised steel steps was clearly modern. An earlier set of steps is however shown on the early plan in a similar location and when the recording was undertaken there was some evidence surviving of this feature. The evidence included a row of bricks set north-to-south into the floor which would have marked the base of the steps and a scar in the adjacent wall from the line of the former stairs.
- 8.3.25 Along the eastern side of the hall there was a narrow block of three rooms, although the southernmost one (G9) was locked and inaccessible at the time of the recording in 2010-11. The northern room (G10) was a secondary addition but the central office (G8) was essentially primary and is shown on the early site plan (Gen Fig 6).
- 8.3.26 In the primary room (G8) the walls were of painted brick (not plastered) above mid-height tongue and groove boarding and there was a large glazed partition above the tongue and groove in the west wall. This glazing however was almost entirely obscured by later alterations including a low suspended ceiling, fluorescent lights and modern plasterboard. The glazing was only visible in the void above the modern ceiling. The ceiling abutted two sash windows in the east wall, each of which had glazed shuttered doors to form a basic form of double glazing. This additional glazing



pre-dated the modern ceiling and the fittings were suggestive of a mid 20th-century date or from the inter war period.

- 8.3.27 The **northern block** inside the building was partitioned off from the central hall by a brick wall which ran the full width of the building from the northern jamb of the original train arch in the eastern elevation. This block originally divided into two areas: an Enginemens's mess room to the east (G5 – see Fig 16.1) and a cleaners stores room to the west (G6-7). The outline of this could still be traced in the final building (2010) although the western area (cleaners stores) had been further subdivided by later partitions. The eastern area (Mess Room) retained its primary footprint although as detailed above a map from 1966 shows that by this date this room had been converted to Filter Cleaning Plant.
- 8.3.28 The only access between the central hall and the northern block was via a doorway towards the western end of the main dividing wall with a segmental arch over a square-headed lintel. This was the result of the original door being infilled and a door re-inserted. This opening, which would have allowed access into the cleaners stores is shown on the early plan (ref: 2515-409-1516. Gen Fig 6). Immediately to the east of this there was a blocked opening with a low concrete lintel, the base of which was c.1.5m above the ground. The door led into a small room (G7: part of the former cleaners stores) with a concrete floor, inner partition walls formed from concrete blocks, all painted white, and simple skirting. Doorways in the north-eastern angle of this room led either into a relatively narrow space lit by the northern windows of Structure 16 or into a small room to the east (G6). A double timber door in the western wall had wired glass windows and a concrete lintel. The ceiling was modern, but masked an earlier tongue and groove ceiling covered with a flaky brown paint. There was a high level window in the northern wall of this room to let light in from an adjacent corridor, which was itself lit by the primary windows in the north elevation of Structure 16. The window also allowed some airflow through a section which was covered in gauze rather than glass.
- 8.3.29 The room to the east (G7 - still within the former Cleaners Room) had a concrete floor and painted walls, the western and northern of which were concrete block and the southern and eastern primary. Its main feature was a chimney breast in the north-east corner, in the same location as a small fireplace on the early plan of the complex (ref: 2515-409-1516). A stepped chimney to service this is pictured in external photographs of the yard from the 1960s. The fireplace had been infilled, but the small, low segmental arch survived, and a vent at c.2.3m above floor level in the chimney had its cover missing, through which the original 25 cm diameter ceramic flue was visible. Just to the north of the fireplace was a break in the construction of the breast. All had been painted white. There was a second vent at head height in the southern wall. On the stores side of the wall this was covered with a slatted grille.
- 8.3.30 There was a door in the northern wall of the eastern room, just beside the chimney breast, and to the left of this was a high level window looking out into the corridor, again with gauze in one quarter of its width. The corridor itself led to pairs of simple double doors which gave access to the covered walkway along the western elevation of Structure 16 or into the space to the east of Room G. The doors were painted blue



and had higher level panes of wired glass. The corridor was heated by floor-mounted space heaters, electrically powered, below the external windows.

- 8.3.31 The eastern half of the north block was a large open-plan room (G5) and historical plans suggest that it remained as a single space from the original construction of the building until its demolition in 2011. As outlined above this area originally served as the Enginemen's mess room until its conversion, probably in the 1960s, to house Filter Cleaning Plant (*Plate 16.23*).
- 8.3.32 Originally there was no access to this room from the rest of the Stores Building and the only access into it was from the outside, via a doorway at the eastern end of the north elevation. This double doorway remained at the time of the 2010 recording but access was also now possible via an inserted doorway in the west wall, from the corridor of the area to the west, and also through the large inserted doorway in the east external wall with roller shutters.
- 8.3.33 At the west end of the room there was a large projecting chimney breast (the other side of the chimney breast noted above) to the south of the inserted 1960s double doors. A 6 ft cooking range is shown here on the early plan of the building and the segmental arch from this range remained visible at the time of the recording although the opening had been bricked up. The opening was c.1.9m wide.
- 8.3.34 The floor in this room was of concrete and generally painted red but there were three large patches where it was unpainted.
- 8.3.35 Heating had been latterly provided in this room by water radiators attached to the northern elevation. A concrete lintel without apparent purpose was set into the southern wall, close by the wall with the hearth. The floor of this room was painted red, but there were a series of unpainted rectangular patches in the southern half of the room. The room was lit by the primary windows in the northern elevation, and by hanging fluorescent strip lights. Large air conditioning ducting was attached to the underside of the ceiling – this vented through the eastern elevation of Structure 16 beside the roller shutter doors. Items left after the room had ceased to be used, and soft stripping had started, included a sign reading 'Battery Room'.
- 8.3.36 The **southern block** of Structure 16 was divided from the main stores area, like the northern block, by an east-to-west aligned brick wall that looked to be of primary build and is shown on early plans. This wall formed the north side of a primary corridor, with plastered walls and concrete floor, that extended across the full width of the building with external doorways at both ends. As outlined above the area to the south of the corridor was originally divided into three rooms (Enginemen's room, Clerks room and Foreman's Room) but when the recording was undertaken in 2010 this layout had been replaced by a new arrangement. The layout was probably altered in the 1960s, largely with the insertion of new partitions but apparently retaining one section of original internal wall.
- 8.3.37 At the western end of the corridor was a lobby partition, beyond which was a modern fire door which let out into the walkway. There was a modern suspended panelled ceiling. There was also a fire door at the eastern end, again beyond a short lobby.



This end was lit by the high level window above the external door. Just inside the lobby door was a blocked door in the wall which had led into the main storage area, opposite which was a door that lead into a room of gents toilet cubicles and washbasins (G2). This room was situated in the south-eastern corner of Structure 16, and so benefited from primary windows in the eastern elevation, and an inserted modern window in the southern elevation. The bottom two-thirds of the walls were tiled with square, white glazed tiles. A bank of four little hand-basins were attached to the eastern wall, and there was also a square Belfast sink set a little lower on the same wall. Two urinals were attached to the northern wall. There was blank staff noticeboard.

- 8.3.38 To the west of the toilets was a mess room (G3), with a small computer server room with stud walls and a stairwell in the south-eastern corner. The server room contained various steel office filing cupboards, one marked 'EWS Storage'. The mess room contained a glass fronted, lockable notice board marked 'Union Notices', with various notices inside dated to 2006 and 2007. As an example, there was an EWS Engineering Bulletin, issue 03, which carried information on the limits of wear for Class 47 Locomotive Brake Blocks. Electric space heaters were attached to the southern wall and there was a suspended panel ceiling. In the south-western corner of the room was a simple kitchen unit with a modern stainless steel sink and a microwave. The window was as the remainder on this elevation – inserted rectangular softwood frames of six lights and standard stock. The blocked doorway in the southern wall was a part of that visible in the external elevation – the stairwell partition post-dated this blocking and it is evident that a wider doorway had been bricked up and replaced with a narrower fire exit door. There was an EWS noticeboard attached to the stairwell partition wall. The winder stairs were of softwood construction, stained brown, with open stair rails. At the foot of the stairs was the Fire Exit door in the southern elevation of Structure 16. There was a high-level glass panel in the northern wall of the mess room that let light into the narrow corridor beyond.
- 8.3.39 A door in the western wall of the mess room gave access to a small lobby. This contained doors into the corridor, and a door into the Team Leaders Room (G4). This was situated in the south-western corner of the building and contained a linoleum floor, desks, a key cabinet, racks for forms, a clocking in rack, a Westclox clock mounted high on the eastern wall and a modern coat hanger rail. The room was lit by two of the modern windows in the southern elevation, and two modern windows in the western gable. There was a suspended ceiling.
- 8.3.40 The southern block returned part way along the eastern wall of Structure 16 and both these elements carried a **mezzanine** level, the southern return being protected by a K-Klamp tubular metal rail within which there was a swing gate to allow goods to be hoisted upwards. The rail here was clearly a replacement of an earlier installation, but the simple, primary rail and baluster survived on the eastern wing of the mezzanine. The southern part of the southern mezzanine was partitioned off to create a separate space. Along the east wall of the mezzanine (as far as a chimney stack) this partition had been well constructed from vertical tongue and groove boards, diagonal bracing and subtle stop chamfers to all the main members. The work appeared primary to the construction of the building, although there was also a secondary phase of tongue and groove partitioning adjacent to the top of the stairs and another east-west section



towards the north end of the mezzanine. This secondary work was of simple horizontal and vertical slats without diagonal bracing, without stop chamfers. But to the west, ranged against the southern wall, was a modern partition wall, possibly dating to the 1980s, which formed office space. It was into this space that the stairs in the ground-floor meeting room climbed. These rooms had uPVC windows, rendered south walls and suspended ceilings.

- 8.3.41 Throughout the building were signs and handwritten pleas which spoke of gallows humour and the staff's daily frustrations. Beside the roller shutter door in the western elevation someone had hand painted the words 'CLOSE SHUTTER SLOWLY', underlining the word 'slowly' twice. In the stairwell of the northern offices was a blue circular sign which said 'This staircase and exitway to be kept clear of goods, bins, rubbish and obstructions'. Beside the top of the stairs on the southern mezzanine was a handwritten sign saying 'BOOK OUT EACH FILTER NOT A BOX', the words 'filter' and 'box' having been underlined. A stray piece of paper exhorted 'DONT (sic) FORGET ITS ONLY A GAME!! SMILE!!'. Someone had responded to a printed poster saying 'Let's respond to this crisis in an intelligent, adult manner ...!' with the words 'Don't worry!!! Much too late!!'.

Structure 16 Plates

- Plate 16.1: General view from north-east
- Plate 16.2: Looking west between Buildings 15 and 16
- Plate 16.3: East elevation of Building 16 from south-east
- Plate 16.4: South side of Building 16 from south-east
- Plate 16.5: South end of east elevation
- Plate 16.6: General view of west elevation
- Plate 16.7: North end of east elevation
- Plate 16.8: Detail of east elevation
- Plate 16.9: Section of north elevation
- Plate 16.10: North bay in east elevation
- Plate 16.11: Door detail in south bay of east elevation
- Plate 16.12: West elevation: south bay
- Plate 16.13: Clock in east elevation
- Plate 16.14: Typical sill detail
- Plate 16.15: Walkway against west wall
- Plate 16.16: Walkway against west wall
- Plate 16.17: Primary stairs at south end of main hall
- Plate 16.18: Primary stairs at south end of main hall
- Plate 16.19: Mezzanine at east end of south bay
- Plate 16.20: Offices etc at east end of hall
- Plate 16.21: View from north mezzanine down to offices on east side of building
- Plate 16.22: Offices along east side of building
- Plate 16.23: Room along north side of building looking west
- Plate 16.24: General view of southern bay looking west
- Plate 16.25: East to west load spreading member
- Plate 16.26: Bearing plate in east wall for east-to-west load spreader
- Plate 16.27: View to north-west from south-east corner of mezzanine
- Plate 16.28: Capital of central column
- Plate 16.29: Roof above south bay
- Plate 16.30: East mezzanine looking south
- Plate 16.31: Truss connecting piece
- Plate 16.32: Roof: north slope of south bay looking north-west



Non-listed Built Heritage Recording at Old Oak Common, Acton Event Code XSU10
C254-OXF-T1-RGN-CRG05-50001rev2

- Plate 16.33: Small pulley wheel above northern mezzanine
- Plate 16.34: South slope of north bay of roof
- Plate 16.35: Roof from northern mezzanine
- Plate 16.36: Truss connecting member

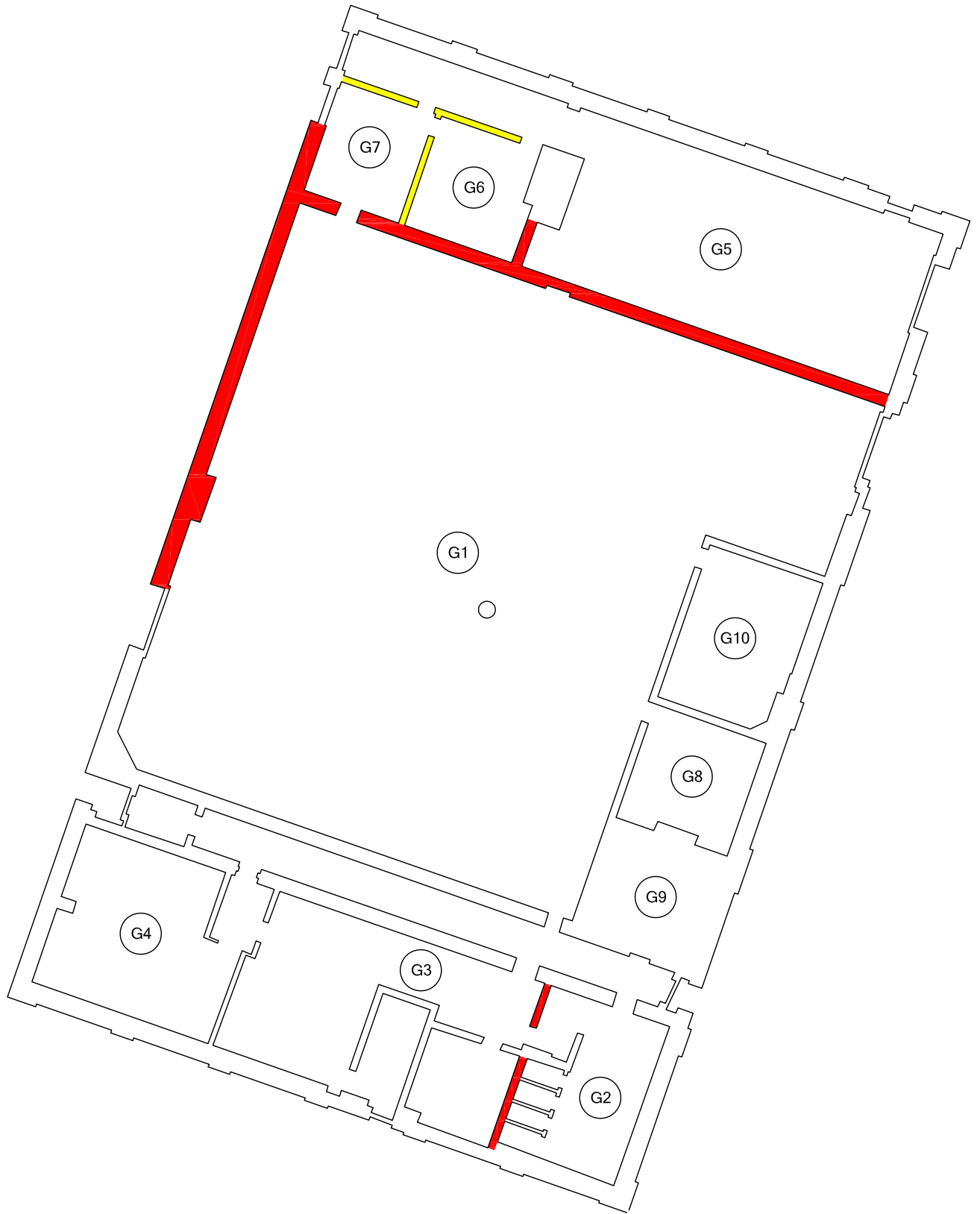
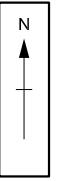

0 10 m
Scale 1:200

Figure 16.1: Building 16, Groundfloor

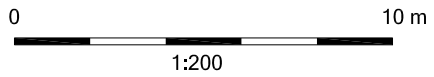
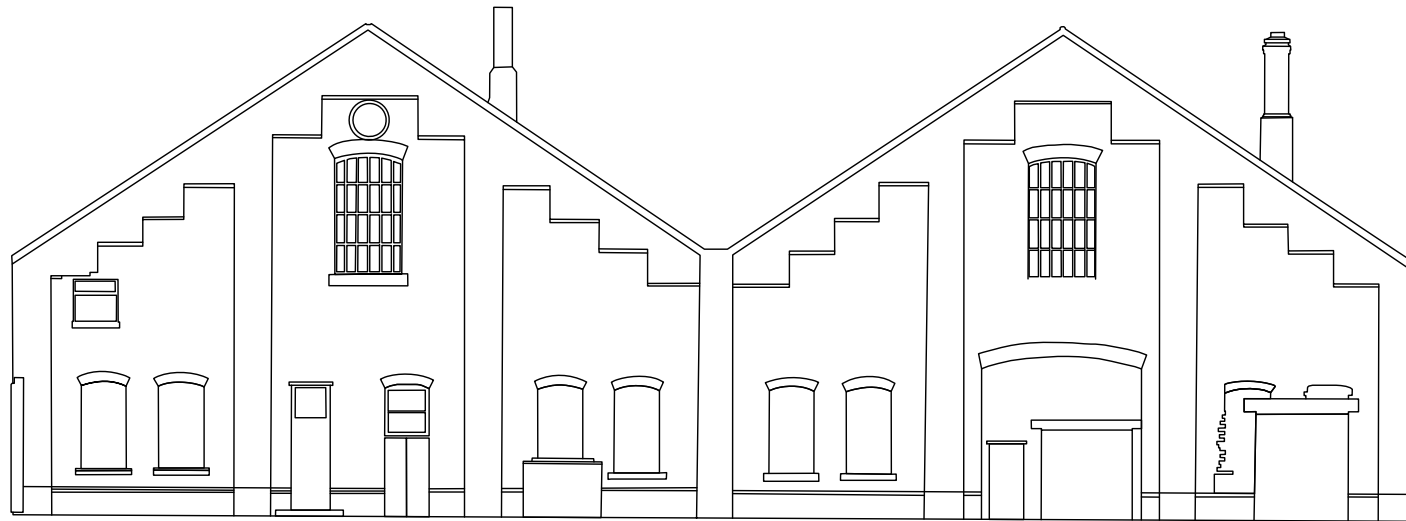
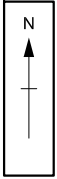

Figure 16.2: East Elevation, Building 16

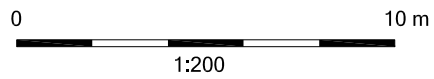
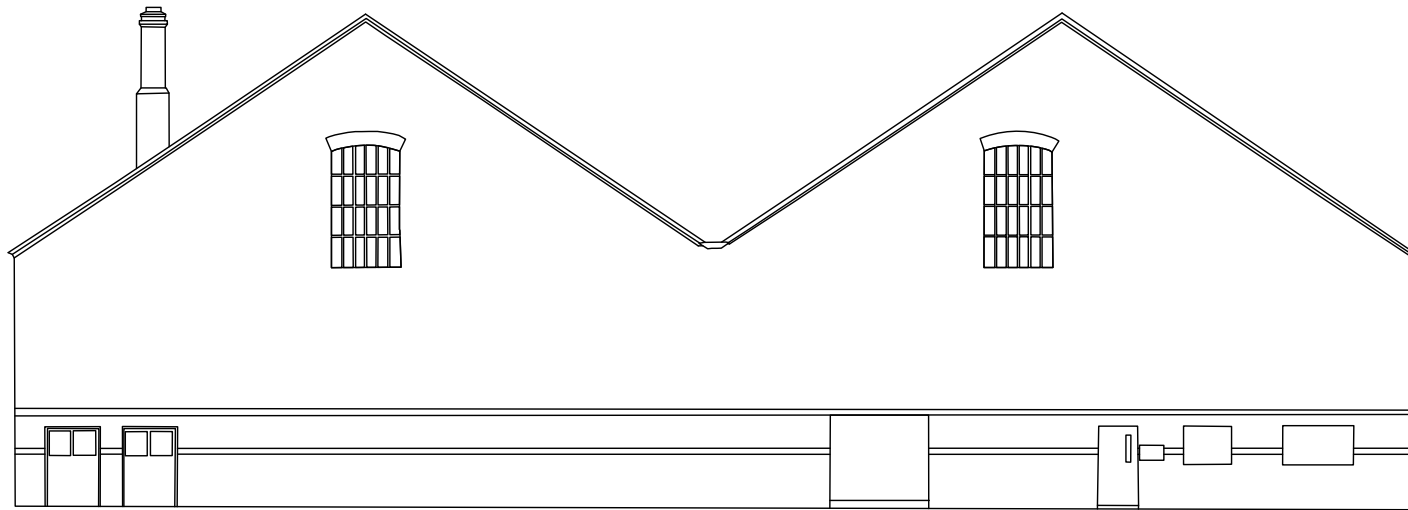

Figure 16.3: West Elevation, Building 16

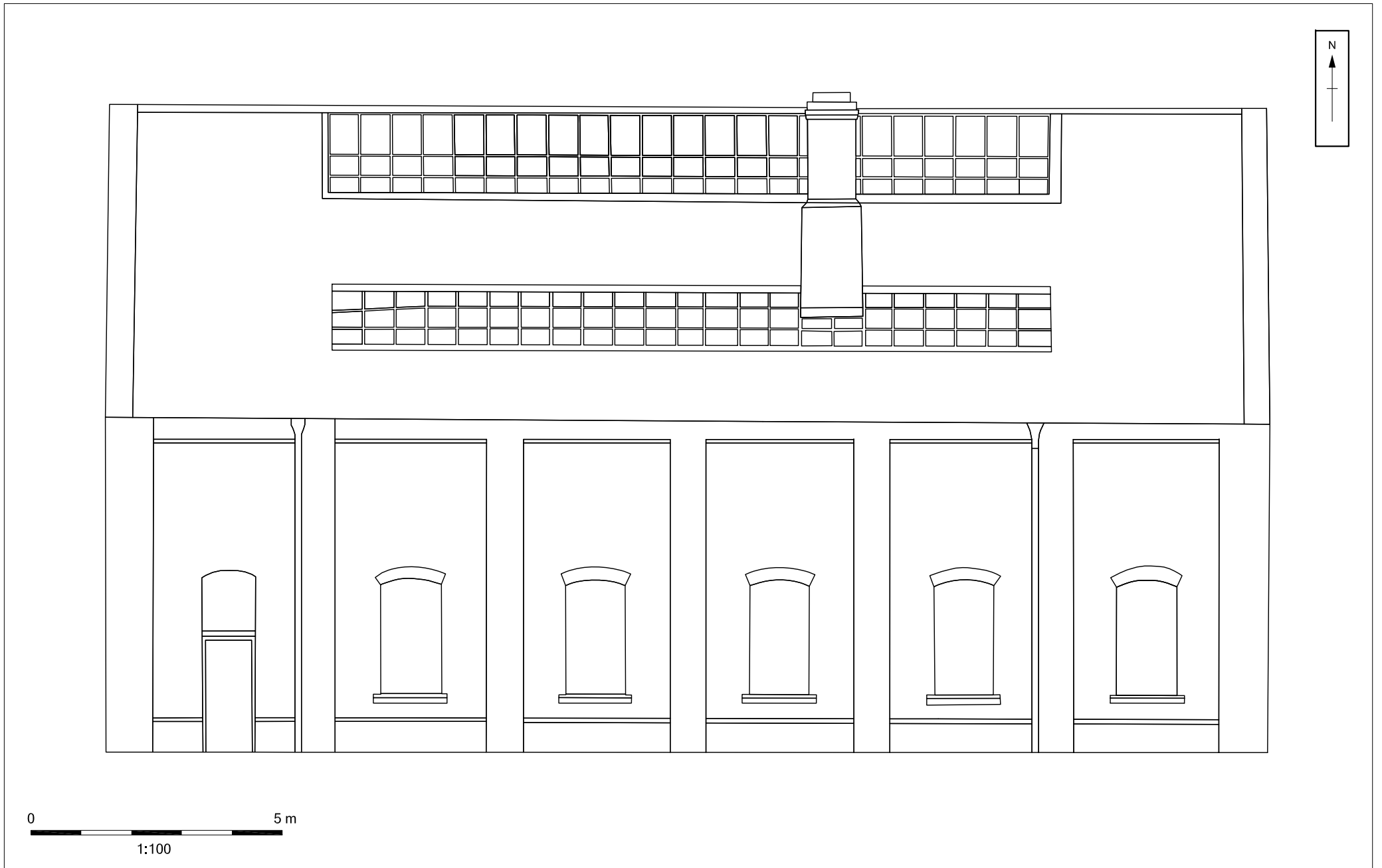
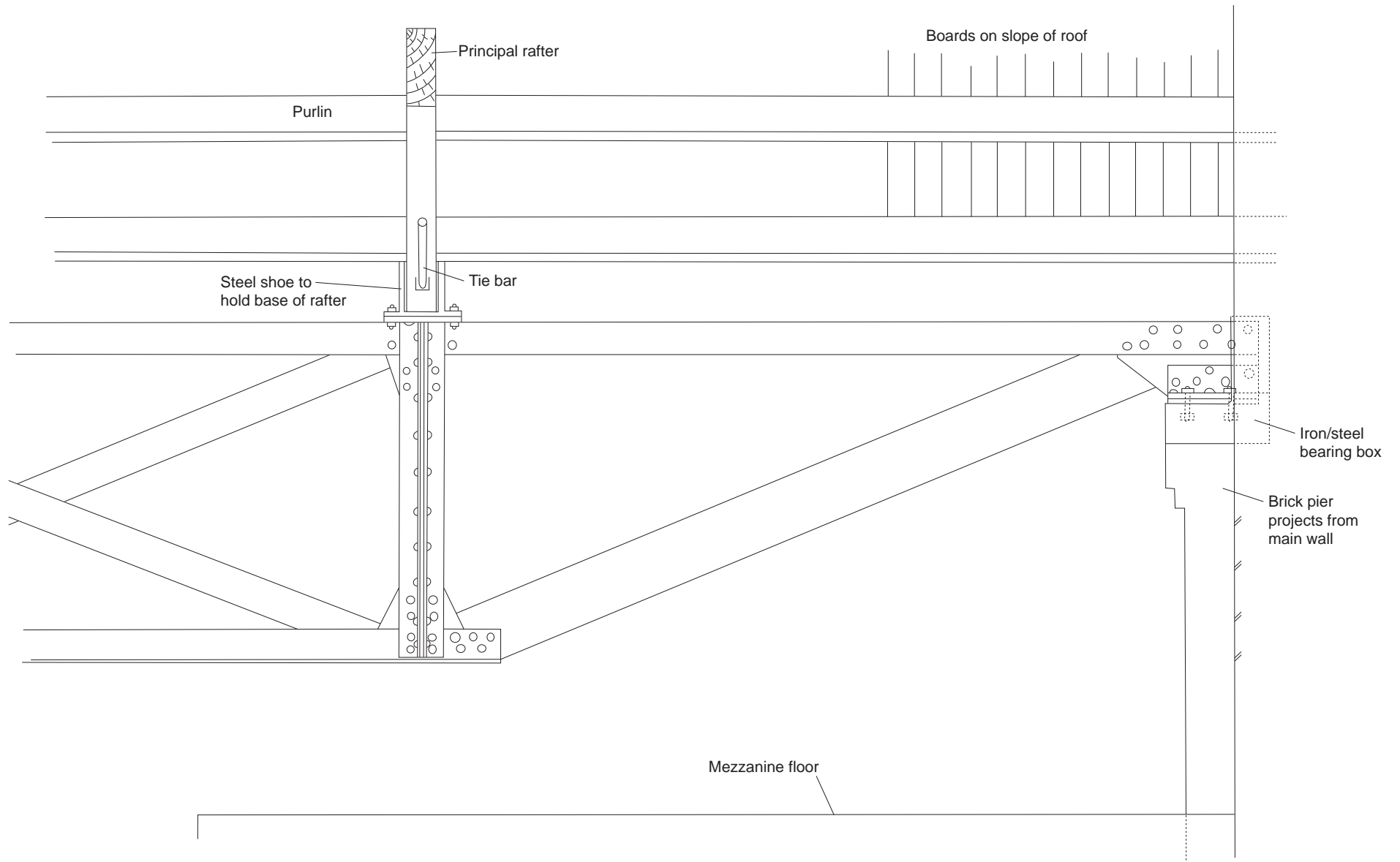
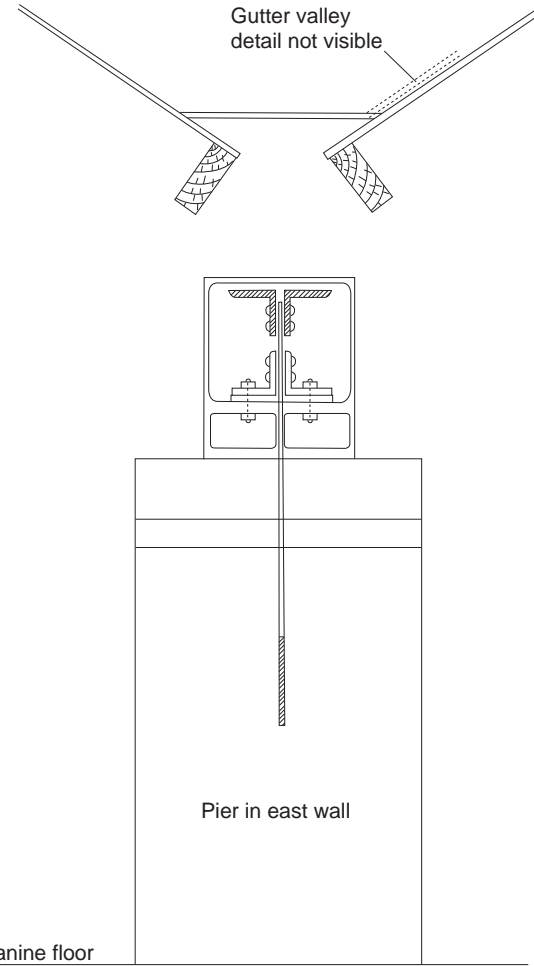
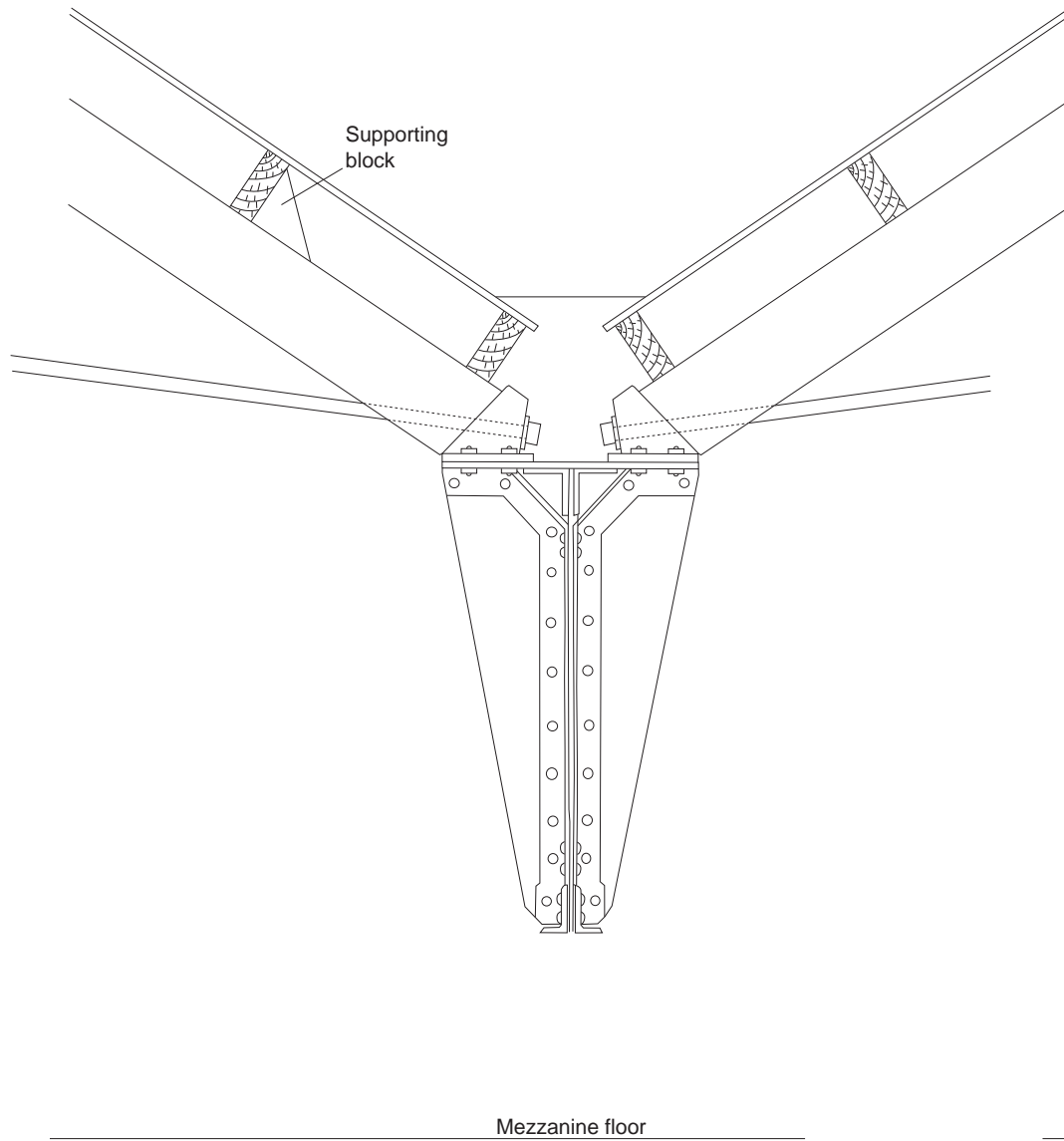

Figure 16.4: North Elevation, Building 16



0 1 m
1:25

Figure 16.5: Structural detail against east wall looking north



0 1 m
1:25

Figure 16.6: Detail of roof supports accessible from mezzanine



Plate 1



Plate 2



Plate 3



Plate 4



Plate 5



Plate 6



Plate 7



Plate 8



Plate 9



Plate 10



Plate 11



Plate 12



Plate 13



Plate 14



Plate 15



Plate 16



Plate 17



Plate 18



Plate 19



Plate 20



Plate 21



Plate 22



Plate 23



Plate 24



Plate 25



Plate 26



Plate 27



Plate 28



Plate 29



Plate 30



Plate 31



Plate 32



Plate 33



Plate 34



Plate 35



Plate 36



9. **STRUCTURE 17A: OFFICE & AMENITY BUILDING, PREVIOUSLY THE CANTEEN**

9.1 **Introduction and summary**

- 9.1.1 Structure 17a was constructed as a General Office building as part of the original 1904-6 Old Oak Common depot and it was located to the south of the Stores (Structure 16). It would originally have been adjacent to the south-eastern corner of the large engine shed which was demolished in the 1960s. The building was converted into a canteen in the Second World War and it was then substantially enlarged, probably in the during the very early 1960s, with the construction of Structure 17b. Together these latterly formed a large amenity building.
- 9.1.2 The DDBA assessed Structure 17a to be of regional significance. It has been recorded in the current project at EH Level 3.
- 9.1.3 The extension (Structure 17b) was recorded at Level 1 and is therefore included separately below.

9.2 **History and map evidence**

- 9.2.1 An original drawing survives from 1903 showing a section through the building and roof details (see Fig 17a.1). The building is also shown on numerous general site plans, initially as a free-standing General Office, separated from the engine shed by a narrow passage. A useful plan shows the ground floor layout as comprising a central spine corridor with offices to each side, fireplaces in most rooms, WCs at the north-west corner, and apparently a spiral staircase in the north-eastern part of the building. (see Gen Fig 6). This plan was re-drawn in 1959 from a damaged earlier plan which was clearly from before the Second World War when the building was still a General Office.
- 9.2.2 A site plan from 1938 confirms that at this date the building was still offices and with little change from the earlier plan while another from 1941 shows that by this date the building (still Offices) had had two small extensions added to its north side. A plan from 1946 shows that by this date the building had been converted to a canteen and there were three narrow extensions shown on the north side of the structure. A plan from 1958 shows a similar arrangement to that from 1946 but a plan from 1966 confirms that by this date the large extension (Structure 17b) had been built. This plan labels the building as Amenities Offices.

9.3 **Description**

9.3.1 **External description**

- 9.3.2 Structure 17a was a two-storey tall, rectangular plan building constructed from red brick and it shared the same general detailing as the other primary buildings from the complex. The brickwork was essentially English bond but with occasional inconsistencies such as isolated piers appearing as headers in stretcher courses, and the bricks measured 23 cm long by 11 cm tall by 7.75 cm tall. Distinctly wider bricks were used at these points. Bullnose bricks softened the corners of the structure and a



high plinth formed from dark blue bricks wrapped around the building. The roof was gabled and clad in secondary tin.

- 9.3.3 The **western elevation** of Structure 17a (*Plate 17a.1, 17a.2, 17a.5*) would originally have faced directly onto the east wall of the large engine shed (demolished in the 1960s) with a passage between the structures, and the elevation reflects the fact that the wall was historically largely hidden. The wall was partially obscured by a steel fire escape to a central door at first-floor level, as well as by an adjoining central walkway at ground floor and a small concrete block enclosure at the north end which blocked access to the stairs. There was one landing in the staircase. The first floor door had re-formed brick jambs and a concrete lintel and was clearly a later insertion. To the north of the door were four small inserted windows, in two matching pairs and with the same type of concrete lintel as the door. The sills were of sloping tiles, and the window frames of metal. The windows gave the appearance of a pair of lavatory windows. Above them, off centre, was a high-level segmental arch. There were no corresponding jambs, but the brickwork below the arch indicated clearly that a window had been blocked. At ground floor level there was a wide, primary segmental arch above a large window in the southern half of the elevation. The window was boarded over with plyboard sheeting. Much smaller segmental arches covered a series of three identical boarded-up windows in the northern half of the elevation.
- 9.3.4 Towards the centre of the west elevation were two ground-floor doorways, one at the centre of the gable line being a primary door opening, now altered, but with bullnose bricks to the jambs surviving. A segmental arch survived at high level above this doorway, below which there was a surviving window and then a section infilling where the roof of the modern walkway led away to the west. The primary detailing to the blue brick plinth survived – there were bullnosed bricks at the edges of openings and two rows of chamfered bricks to form the shoulders to the plinth top. On the third plinth course from ground level two render filled holes had been made in each brick, presumably to aid injection of a damp-proof course. To the south of the main central doorway was a much smaller door beneath a concrete lintel. Although its jambs had been reformed it was clear that this was also a primary opening as the plinth at this point was stopped with bullnose bricks. At first floor level there were several infilled holes in the southern half of the elevation, suggesting that there must have been a walkway or adjoining structure at one point.
- 9.3.5 The main architectural feature of the **south elevation** (*Plate 17a.4; Fig 17a.4*) were 12 attractive full-height windows, each with segmental arches and sloped blue brick sills. Most windows were separated by four bricks in the stretcher courses, but there were two intervals of seven brick widths, and one of five. The window frames were uPVC replacements. The roof covering had been replaced with a functional grey-coloured corrugated tin system, except where irregularly-spaced rooflights survived towards the apex on both pitches. Rainwater goods were modern steel replacements. A small structure, which probably served as a secure transfer box into the building, had been constructed between and below the fifth and sixth windows (from the western gable). This had been built of brick with a sloping concrete roof and had an impressively solid-looking stainless steel door and surround. Towards the eastern end of the elevation a door opening of double width had been inserted into the bottom half



of the tenth window from the western end. This had a broad concrete hood covered with lead flashing.

- 9.3.6 The **northern elevation** (*Plate 17a.3*) was probably originally similar to the southern although it had been more significantly altered and historic map evidence shows that there were formerly three small, narrow extensions along this elevation. Only one of these extensions still survives: a small concrete-rendered lean-to at the western end. Nine windows, identical to those in the southern elevation, survived. A large opening had been inserted towards the eastern end of the elevation, its lintel height being equal to the top of the window's segmental arches. The surround to the opening was of thin-profiled concrete, the jambs of which were battered curiously outwards towards the ground. This surround contained a large lower panel, boarded, above which was a row of four square lights. The inner edge of the surround had been clad with blue tiles, some of which were now missing. There were two square ventilation grilles at high-level, marked 'Brooks Ventilation Units Ltd' (a company founded in 1984). There was a door in the eastern end of the northern elevation and five small high-level windows, three in the northern elevation. This looked like a WC.
- 9.3.7 The original **east elevation** of the building was entirely enclosed (or removed) by the construction of the adjoining Structure 17b in the very early 1960s.
- 9.3.8 Internal description**
- 9.3.9 The **ground floor** of the building (*Fig 17a.2*) appears to have been substantially altered in the c.1960 conversion from a canteen to the amenity/offices and the layout redesigned. Presumably when the building functioned as a canteen it would have been relatively open plan but the c.1960 works returned the plan of the building closer to that of the original Edwardian structure with 12 small rooms (offices), arranged to either side of a central spine corridor.
- 9.3.10 The rooms were accessed from the double door in the southern elevation and the central door in the western elevation. The rooms performed a variety of different functions. The central corridor that served these rooms was made an awkward space by a row of central concrete columns, 0.32m square, with a heavy 'Y'-shaped head carrying longitudinal RSJs. The RSJs must have carried transverse beams, because the primary floor construction at first-floor level was of longitudinal joists. The same line of concrete Y-posts continued through into Structure 17b.
- 9.3.11 In the north-western corner Room G1 was lit by the four little windows in the west gable, and also two windows in the northern elevation. The westernmost of these had been bricked up except for the top 0.4m, in order to accommodate the lean-to. A concrete column supported the upper floor. The adjoining room, G2, had a sign on the door for 'Virgin Trains booking on point' and various noticeboards on the west wall in glass-doored cabinets. There was a primary (Edwardian) 8-over-8 sash window surviving in the north elevation with wedge-shaped non-moulded glazing bars and little finger plates at the bottom to pull up the sash. Room G4, to the east of G2, was lit by one window, of similar type to that in G2.
- 9.3.12 Room G7 beside G4 had two rows of water pipes situated c.0.3m above the floor, possibly indicating that the room had been used as a drying area (*Plate 17a.8*). There



were two windows – the western window was primary, that to the east secondary, albeit still a timber sash with four over four panes. The room also contained a large board with hundreds of little hooks, possibly so that staff could hand in their uniform for drying and be given a token to ensure that they are returned the correct uniform (*Plate 17a.7*). Room G8 was featureless except for one secondary four over four sash window.

- 9.3.13 Room G3, in the south-western corner, featured a carpet-tiled floor (*Plate 17a.11*). There were three main windows, all uPVC replacements, but their moulded architraves (*Plate 17a.13*) indicated that this room was, and had been originally, of higher-status. Although the ceiling was formed from 1960s panels where some of these were missing an original moulded cornice and ochre-coloured walls were visible (*Plate 17a.12*). The cornice extended along the whole of the south wall and three-quarters of the way along of the eastern and western walls. The break in the cornices on these walls was probably due the presence of a since removed east-to-west aligned partition that would have separated the room from a corridor entered by the former door in the west gable. Breaks in the skirting board also reflected this. In the north-eastern corner of the current room there was a studwork and plasterboarded lobby. What appeared to be a chimney-breast was present in the east wall and on the south corner of this was a roll moulding detail.
- 9.3.14 Room G5, to the east of G3, also had carpet tiles and a suspended ceiling (*Plate 17a.10*). There was a sink unit set into a worktop with cupboards beneath against the south wall, around which the carpet gave way to square brown floor tiles. A modern wall-mounted boiler provided hot water. The skirting was plain, and there was no original cornice. The plain architrave was another sign that this room was originally of lower status. The windows were all replacement uPVC set into primary openings. A series of 1960s hatches along the north wall had been boarded up in the 1980s. The inner door of the secure transfer box was situated to the east of the sink unit. G5 had been partitioned by the construction from concrete blocks of a small room in its north-eastern corner (Room G6). This contained several safes (two at floor level and a third at picture rail level) and a cashier style hatch formed by a thin horizontal tray below a glazed window, a door that opened internally, and a shelf and cupboard to the right. The heavy-duty door into this room was clad in a timber veneer, but may have encased a steel door. Certainly, the frame was of angled steel. There was a small observation window glazed with security glass in the door. The floor level safe beside the door had two doors, enabling goods to be passed into the room without the main door being opened. The outer of the safe doors corresponded with the inner door of the secure transfer box in the outer wall of Structure 17a, thus enabling goods to be passed from outside the building via the narrow corridor to the south of G6, and directly into the safe room.
- 9.3.15 Room G9 was to the east of G5/G6 and it had three primary window openings with uPVC fittings and plain architraves. The east and north walls were of studwork, the west wall of concrete block (being G6) except where a short passage allowed access via a door into G5. There was a hatch in the centre of the north wall, a nib of masonry at the south end of the east wall and where some tiles from the suspended ceiling were missing the primary plastered walls were visible. There was no cornice.



- 9.3.16 Rooms G10 and G11 occupied the north-eastern corner of the ground floor and were effectively one space, being separated by a wall with a wide opening at its southern end (*Plate 17a.9*). Both rooms had functional racks made from steel fencing pipes, below which were low-level hot water pipes. The east wall masonry was probably primary but had been plastered over – the west wall and south walls of both rooms were of studwork. The large opening in the north wall (described externally above) was boarded over, indicating at least three phases of building work. There were large, simple high level windows in the south walls of both rooms.
- 9.3.17 The **first floor** of Structure 17a divided into three main distinct sections:
- 1) at the eastern end, adjacent to the c.1960 extension (Structure 17b) was an area (F7) flanked by primary brick walls which contained the main staircase to the upper floor and comprised a concrete slab floor at the lower level than that of the main primary upper floor.
 - 2) at the western end was a further narrow block of three rooms flanked by primary brick walls. These rooms included WCs and they continued towards the eaves (thereby with a longer slope to the ceiling).
 - 3) In the main central part of the floor, between the blocks at either end, was a long section which contained a row of rooms along the spine of the building. To either side of these (ie to north and south) were substantial roof voids. This area had been much altered by secondary works although the primary trusses remained.
- 9.3.18 The *easternmost block* (F7) contained the main north-to-south dog-leg staircase as well as two small rooms located in the northern part of this area (Rooms 7a & 7b). This end of the building had been significantly altered by the c.1960 works, including the insertion of a concrete slab floor c.1.15 m below the rest of the primary first floor, and the stairs clearly also dated from this phase of works.
- 9.3.19 The stairs (*Plate 17a.14*) were of concrete with a good quality wooden handrail of rectangular section with curved turns, carried on circular steel banisters painted black. The landing was lit by two windows, both of which had originally had wooden jambs and architraves, and which finished at floor level. High-level brackets had carried roller blinds. The landing had been lit by a fluorescent strip above the windows. The landing floor was of concrete, with a rounded detail where it met the walls. The steps had white lines painted on the edges of the treads, and the risers were slightly angled. The first, shorter flight had two sets of banisters and handrails, and landed facing north. Beyond was a small studwork and plasterboard cover which separated the stairs from the remainder of the ground floor.
- 9.3.20 F7 contained a firehose on the east wall beside the door into F6. The walls of F7 were all plastered, and painted cream above a greyish blue. The walls to the west and east were all primary brick, that to the north was concrete block. The ridge was visible above the level where the ceiling had been (recently) removed. The south pitch contained an extra purlin which had been added directly above the third purlin up. In this area the original purlin stopped before the west wall and at this point several roof boards had been replaced. The primary roof lights had clearly once extended across the westernmost two-thirds of F7 but these had been boarded-up in the 1960s. Trimmers on the south pitch were evidence of a now boarded-up 1m wide rooflight,



probably added in the 1960s, between the fourth and fifth purlins. This would have presumably helped light the top landing of F7. The east wall of F7 had a door that let into Structure 17b to the east, thereby providing the reason why the floor was lower. Above this door, in the east gable of Structure 17a, was a high level rectangular window with a painted concrete lintel.

- 9.3.21 At the head of the stairs was a landing of there were two further rooms off this to the north (F7a to the west and F7b to the east) each accessed by separate doors in F7's north wall. F7a had concrete block walls to the south and east, and original brick walls to the west and north walls (*Plate 17a.15*). There was original render on the west wall up to c.1.3m, and at the south end the west wall was covered with large patches of lime green paint above a pink paint, with a clearly defined line at dado rail height between the two. The doorway into this room was of double width single-panel doors. The original timber was exposed and had been painted white. Room F7b was similar to F7a, but was smaller and contained a simple Belfast-style ceramic sink behind which the wall was covered with square blue tiles. The function of this room is not clear, but the fact that the sink had a metal strip attached to its leading edge, and a hinged heavy duty rack that folded down to rest on the strip, suggested that this was not a room for general staff use.
- 9.3.22 *The westernmost block* of Structure 17a included a number of utility or service spaces. Room F1 provided access to the fire exit door and escape noted above in the western elevation (*Plate 17a.27*). There was painted brick to the east and west walls and vertical tongue and groove boarding (possibly primary) to 1.25m on the south wall. The west wall contained the external fire door and a rectangular six-light timber window, the upper three lights opening inwards. The sill was simply angled concrete. The purlins were exposed but the boards they carried had been obscured by hardboard panelling. All had been painted white. A single panel fire door gave access into the room to the east. There were floorboards of 14cms width, almost certainly primary, over joists measuring 20cms by 8.5cms. The joists ran east-to-west in the southern third of the building, but north-to-south across the remainder. There was a rooflight.
- 9.3.23 The north wall had two doors, the one to the east to the gents WC (Room F2), the one the west to the ladies WC (Room F3). The door to the gents was an attractive four panel timber door (possibly primary), that to the ladies a replacement single panel version. Both carried pleasingly designed signage. The gents had two attractive ceramic hand basins attached to the east wall, and a northern wall of tongue and groove panels. Equally attractive was the thin cast-iron radiator attached to the southern wall, above which was a steel cowl, and to the left of which was an over-square hatch into the crawl space beyond. The floor was of linoleum over floorboards and there was plain blue-painted skirting. The toilet was in a separate cubicle against the east wall of Structure 17a, accessed via blue-painted four-panel door and lit by a little window.
- 9.3.24 The *central part* of the first floor was quite different to the end blocks and contained three office-type rooms along the spine of the building (F4-6). These were created by concrete block walls along the length of the building and beyond these walls were



substantial roof voids to the eaves. The primary first floor structure largely survived in this area.

- 9.3.25 These rooms between the brick end bays were divided into six bays by five primary queen post trusses. The form of these trusses remained close to that shown on the 1903 cross section drawing (see Fig 17a.1) although they were partly obscured by the concrete block walls which ran parallel to the trusses and were aligned with the queen posts. The queen posts themselves remained in-situ, abutted by the concrete block walls. The posts, originally painted white and then a light brown/beige, measured 22cms x 7.5cms. There were six purlins to each slope, each of which measured 23cms x 9cms, as did the collars. The trusses carried rails for fluorescent strip lighting and there were full length roof lights to either side of the apex.
- 9.3.26 All rafters and boards were exposed, but this was a recent development. The floorboards were stained by grime, presumably from a use prior to the most recent offices. The crawl spaces at the foot of each pitch were lit and contained several discarded cupboards and shelf units, one of some height and with labelled compartments. There were also many elaborate coathangers with wire trays at the base. The rafters in the crawl spaces were white washed.
- 9.3.27 The largest room in this section was the central one (F5) and this was marked as *Training Room* on the fire door into F6 (*Plate 17a.20-22*). This room contained a large set of built-in shelves in the north-eastern corner of the room, an attractive cast iron wall-mounted radiator and ventilation fan on the southern wall, and a 1960s' water-fed heater. This room was three bays long and the two sets of primary trusses were clad in hardboard painted blue.
- 9.3.28 Room F4 was to the west of F5 and it was two bays wide. This room was raised by c.5cms, presumably because of an additional floor covering. The walls were all plastered with a plasterboard stud wall to the east and concrete block walls to the north and south (*Plate 17a.17, 17a.18*). The concrete block walls separated F4 from the crawl spaces behind.
- 9.3.29 The smallest room in this section was that at the east end (F6) and this was essentially a small lobby between F7 in the eastern block and the office rooms to the west. The room incorporated a flight of eight dark softwood steps up to the higher primary floor level. The western, northern and southern walls of this room were of concrete block, but the eastern wall was of primary brick. Although the majority of the east wall was painted the upper part, above the line where the original ceiling would have been, was exposed and displayed the original brickwork. The floor was boarded. Doors in the south and north walls gave access into the crawl space towards the eaves and beneath the roof. Insulated heating pipes ran along base of the south wall. The exposed, original, roof was formed of joists measuring 0.08m by 0.27m, covered with boards of 14.5cms width and 3cms depth.

Structure 17a Figures

Figure 17a.1: Original drawings of Offices (Building 17a) from 1903

Figure 17a.2: Ground floor plan of Building 17a

Figure 17a.3: First floor plan of Building 17a



Figure 17a.4: South elevation of Building 17a

Structure 17a Plates

- Plate 17a.1: West and south elevations
- Plate 17a.2: North and west elevations
- Plate 17a.3: North elevation
- Plate 17a.4: South elevation
- Plate 17a.5: West elevation
- Plate 17a.6: Primary plinth detail
- Plate 17a.7: Room G7 looking south
- Plate 17a.8: Room G7 looking north
- Plate 17a.9: Room G9 looking south-west
- Plate 17a.10: Room G5 looking south-east
- Plate 17a.11: Room G3 looking south-east
- Plate 17a.12: Exposed fragment of primary ceiling cornice in G3
- Plate 17a.13: Primary window detail in G3
- Plate 17a.14: Top of the stairs (F7) looking south
- Plate 17a.15: Room F7a looking north
- Plate 17a.16: Room F7 looking west into Room F6
- Plate 17a.17: Room F4 looking west
- Plate 17a.18: Room F4 looking east
- Plate 17a.19: Truss detail
- Plate 17a.20: Room F5 looking east
- Plate 17a.21: Room F5 looking west
- Plate 17a.22: Room F5 looking west
- Plate 17a.23: Detail of apex connector in truss
- Plate 17a.24: View within Loft space (crawl space)
- Plate 17a.25: Detail of roof truss in loft space
- Plate 17a.26: First floor window at west end of building
- Plate 17a.27: Room F1 looking south-west
- Plate 17a.28: Inner face of wall at west end of first floor



Figure 17.2: Building 17a, Ground floor plan



Figure 17.3: Building 17a, 1st floor plan

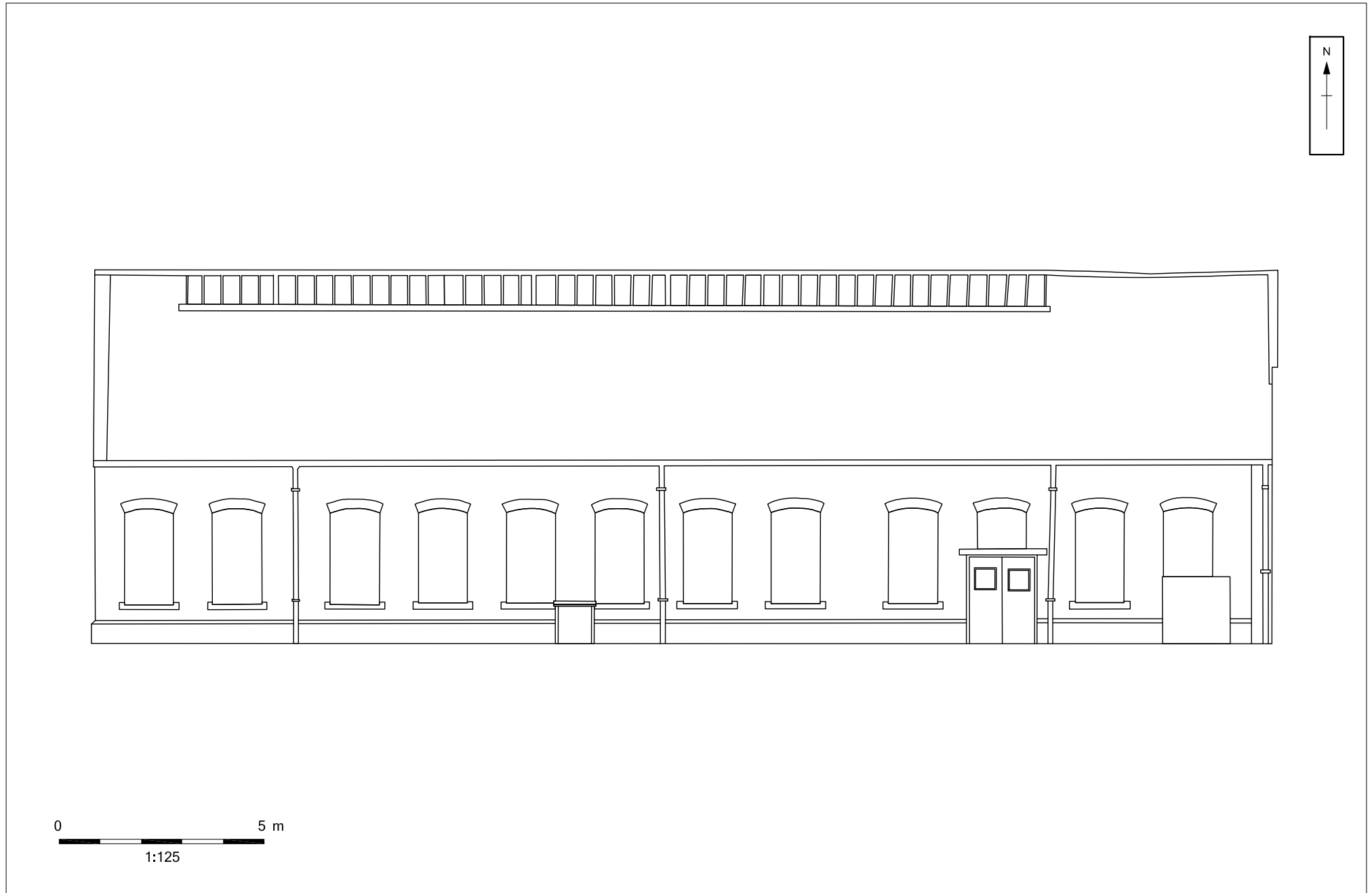

Figure 17a.4: Building 17a, South facing elevation

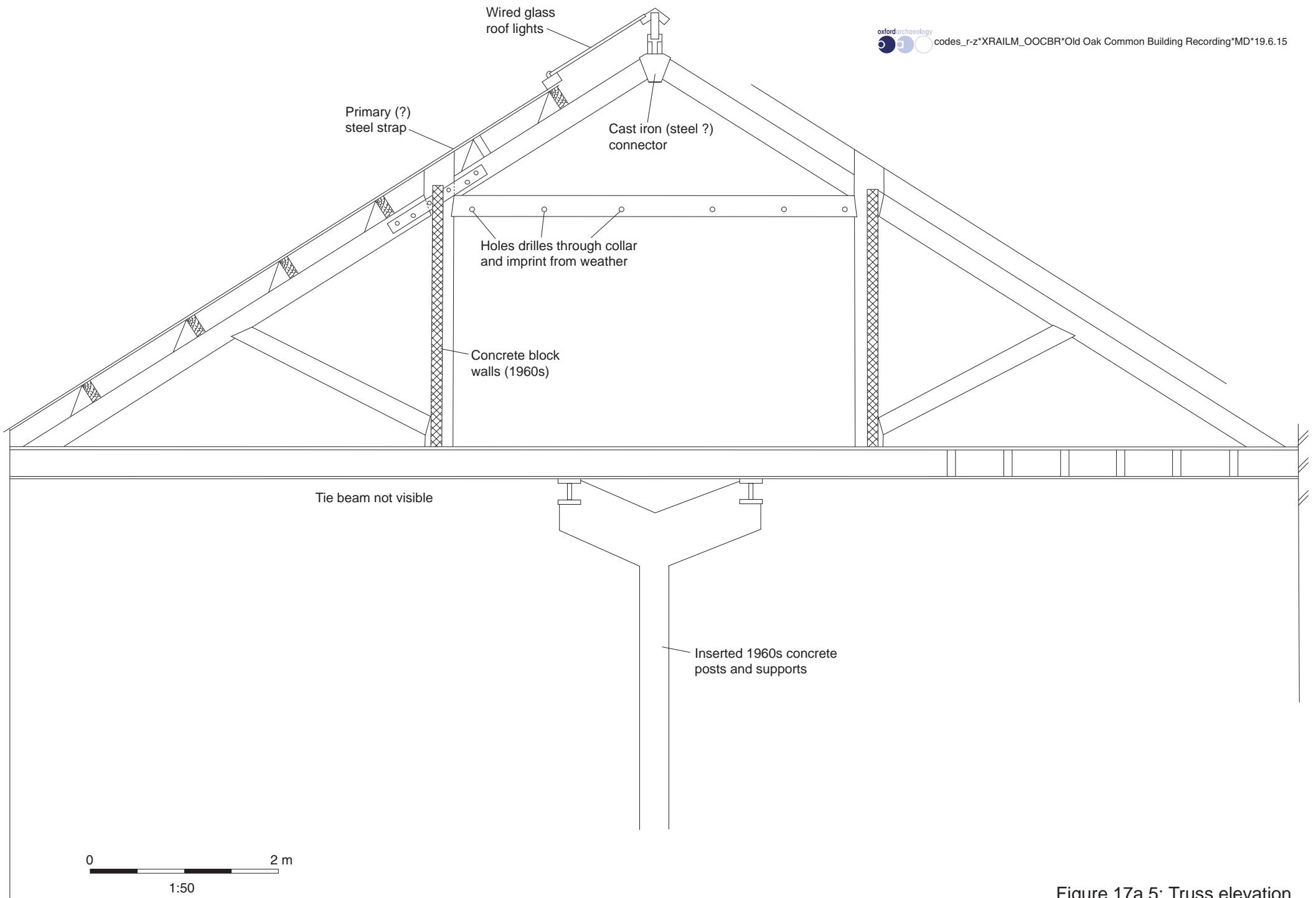

Figure 17a.5: Truss elevation



Plate 1



Plate 2



Plate 3



Plate 4



Plate 5



Plate 6



Plate 7



Plate 8



Plate 9



Plate 10



Plate 11

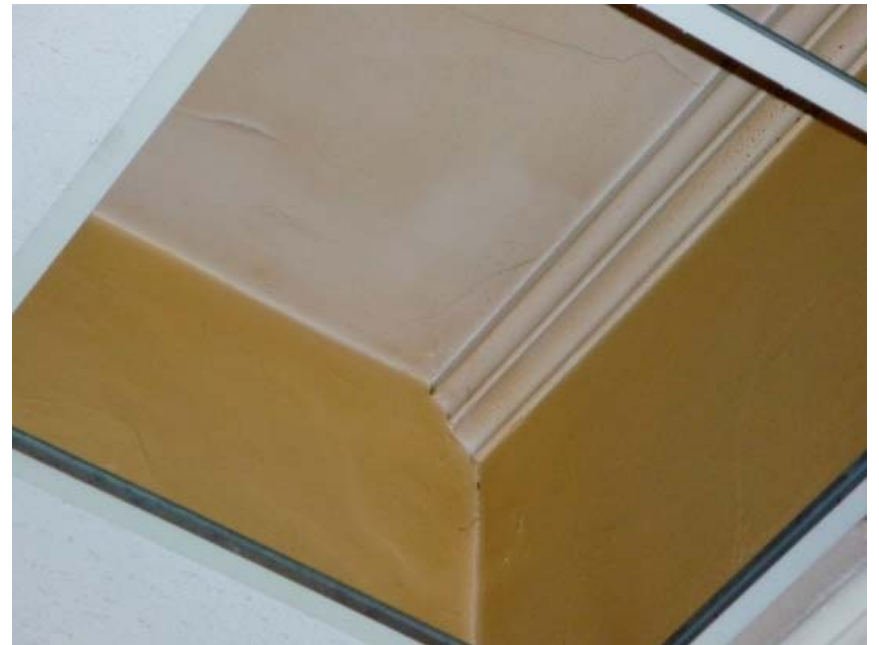

Plate 12



Plate 13



Plate 14



Plate 15



Plate 16



Plate 17



Plate 18



Plate 19



Plate 20



Plate 21



Plate 22



Plate 23



Plate 24



Plate 25



Plate 26



Plate 27



Plate 28



10. **STRUCTURE 20: WORKSHOP, PREVIOUSLY THE MESS ROOM AND SAND FURNACE**

10.1 **Introduction and summary**

10.1.1 Structure 20 was part of GJ Churchward's original Old Oak Common complex (1904-6) and it was located towards the south-western part of the complex. It faced onto the north elevation of the Pullman Shed (Building 22) but it was originally constructed against the south wall of the primary engine shed that was demolished in the 1960s. Indeed this one of the few parts of the complex that retained fossilised parts of the engine shed; in this case part of its southern wall.

10.1.2 The DDBA assessed Structure 20 as being of regional significance. It has been recorded in the current works at EH Level 3.

10.2 **History and map evidence**

10.2.1 Although archaeological evidence suggests that Structure 20 was a secondary addition, constructed against the external wall of the engine shed, documentary evidence and historic maps suggest that it formed part of the original 1904-6 complex and must therefore have been a very early addition.

10.2.2 A drawing survives from 1902 including a plan, sections and elevations for the Sand Furnace House at Old Oak Common and this strongly appears to be the same building that was erected. A site plan of 1906 (Fig 7) shows the Sand Furnace against the south wall of the engine shed, as well as another similar sized Sand Furnace against the north wall of the shed. Structure 20 is similarly shown on a plan of 1930 (Fig 8), again labelled as a Sand Furnace, but we know that in the later 1930s (or possibly very early 1940s) it was converted to a mess room.

10.2.3 A proposal plan from 1937 survives entitled 'Proposed New Messrooms in Old Sand Furnace House and New Cloakrooms in Old Messrooms' (2515/406/1370, Fig. 20.1). The plan indicates that the existing sand furnace and coal bunk was to be removed, and replaced with two messrooms and a kitchen area against the south wall with a sink, gas ovens and a gas boiler, and a zinc counter against the northern wall to service two serving hatches. Each messroom was served by one hatch, in front of which there was a rail. The eastern room was to house up to 62 men (cleaners), whilst the larger western room was to accommodate 108 men (mechanics and shed staff). A wall separated the areas which were entered by separate, but adjoining, doors, both later replaced by the sliding door recorded in 2010. The building was increased in size by removing the western gable and extending the structure westwards by 24'. Other alterations included the chimney being taken down, vent openings in the roof closed and hoppers taken away and openings bricked up. The floor was to be of 'Decolite' over 6" of concrete. A new sand furnace house was constructed against the northern wall of the Engine Shed.

10.2.4 Although the proposal plan is dated 1937 we don't know exactly when the conversion works were undertaken because a site plan from October 1938 still labels the building as a Sand Furnace. A site plan from 1941 confirms that the works had been



undertaken by this date because although the function of the building is not labelled the new layout is indicated. A further plan from 1943 also shows the building divided into three sections with the mechanics mess room to the west, the cleaners mess room to the east and a kitchen in between. A plan from 1949 shows that by this date an ambulance room had been added in an extension at the west end and a plan from 1958 shows a small workshop at the east end.

10.3 Description

10.3.1 External Description

10.3.2 Structure 20 comprised two distinct elements: the main primary Edwardian building and an extension at the west end that was constructed in the 1940s as an Ambulance Room (see historical background above). The main building was a largely single storey structure (other than a mezzanine at the east end) with a rectangular plan (31.5 x 8.75 m) and with a monitor profile roof where the central section was raised slightly to allow long lines of vertical slat vents. The roof was clad in modern pre-fabricated panels.

10.3.3 The building was constructed of red brick and the general detailing was similar to the other early buildings, clearly intending to closely match, but it was not slavishly identical. The detailing generally appeared to be on a slightly smaller scale. The similarities were found in the stepped top of each panel, where the undersides of the frogs were visible (similar to Structure 15a), the sills formed from large sloped special bricks, the dark blue brick plinths (although lower than elsewhere), and in the English bond bricks. The main walls were 50 cm thick.

10.3.4 The **south elevation** facing the road had seven 20-light windows although the westernmost one had been converted to a doorway (*Plate 20.1; Fig 20.3*). With this western bay the upper part of the window had been bricked up (12 courses) with modern brickwork and a plain fire-exit door inserted beneath. The fact that this was clearly formerly a window was shown by the fact that the plinth had been cut to allow for the doorway. Each of the windows in this elevation were square-headed and with a brick-faced lintel (vertically laid bricks with concrete lintel on inside face of wall). The plan from 1937 (*Fig 20.1*) shows that these windows were inserted in this phase of work. The lower 1.75 m of the elevation had been painted white and although this obscured the colour of the bricks in the plinth it was clear that they were the same dark blue as in other primary buildings.

10.3.5 The south-east and south-west corners of the elevation were formed of bullnose bricks with a stop chamfer at 1.95m above floor height. Four cast-iron downpipes were attached to the outside of the south wall. These were not primary – the plinth had been cut to accommodate their passage.

10.3.6 The **northern elevation** (*Plate 20.6; Fig 20.4*) was among the most interesting parts of the building because this represented one of the small surviving parts of the great engine shed which would have dominated the original Old Oak Common depot but which was demolished in 1964. Therefore the external (north) elevation of Structure 20 was originally an internal wall within the engine shed and it appears that the internal (south) face of this same wall was originally (briefly) the external face of the engine shed. The internal face of this wall is described further below in the internal



description. The fact that this was originally an internal wall was illustrated by its relatively plain nature and the way that the wall was fully painted white.

- 10.3.7 The elevation divided into three distinct sections, each of broadly similar size. The western end was of most interest as it was largely of primary engine shed brickwork and it retained two primary windows, also from the great shed (Plate 20.8 – 20.10). These windows comprised segmental arches, with standard metal glazing bars separating four rows of six tall lights, and standard sills sloping into the building. A simple line of flashing continued across the windows (presumably added after the demolition of the shed) and although much of this wall was of primary brick the upper section at the west end appeared slightly different. The brickwork here was distinct but it was very similar to the original and it may have been added when the sand furnace was added, shortly after the construction of the engine shed. At the very western end of the wall, in the area where it faces the 1940s Ambulance Room, the brickwork appeared to incorporate sections from both the original engine shed and the 1940s alterations.
- 10.3.8 The central section of the north elevation comprised a large opening roughly inserted into the wall (post-dating the demolition of the shed) with two sliding steel doors. The lintel was formed by an RSJ, above which concrete blocks had been laid to complete the alteration. The 'jambs' were roughly finished.
- 10.3.9 In the eastern part of the north elevation the brickwork was largely primary but with various alterations (Plate 20.7). Here there was an inserted doorway with reformed jambs and reformed brickwork over an inserted concrete doorway. This lintel had simple stop-chamfer detailing similar to that found in internal beams in the 1940s Ambulance Room at the west end of the building. To the west of this doorway was an inserted window within a large section of secondary brickwork but it was interesting to note that this brickwork was broadly in the shape of a doorway and above it was a partially surviving, 3-brick high segmental arch lintel. This suggests that there was a doorway here between the sand furnace and the engine shed and this is confirmed by the 1902 plan of the building. Approximately half the former lintel appeared to remain in-situ and the full width lintel would probably have been 20 bricks wide.
- 10.3.10 The **eastern gable** (Plate 20.4) had a monitor profile with raised central section which would have formed an end to the slat vents which extended along the sides of the building. The east wall also had crow-stepped panels to match the site's other original buildings, and a centrally placed, circular, bullseye slatted vent towards the top. An inserted doorway was situated towards the south end, the brickwork around it having been reformed using old bricks. This had a concrete lintel and contained a signed fire door. The roof ridge was not quite central to the line adhered to by the vent and inset panels, probably because the wall width differential caused by re-using the south wall of the engine shed made symmetry difficult.
- 10.3.11 An outside urinal, measuring 1.8m by 3.6m externally, was attached to the north-east corner of Structure 20. This comprised a small building with a flanking wall protecting the doorway. A window was let into the northern wall which remained a part of the engine shed, the external plinth of which was still visible. The urinal, being built of Fletton bricks, was of mid 20th-century date and must pre-date the demolition of the



engine shed in 1964 because it incorporates a section of the wall of that structure. The brickwork of the urinal is suggestive of a post-war date and it must have replaced a smaller urinal, shown on the 1937 plan, which was detached from Structure 20.

10.3.12The **west elevation** of the original building was largely obscured externally by the construction of the low extension apparently first shown on the 1949 plan (*Plate 20.1*). The upper half of the original elevation was visible above the extension and similarly to the east wall it had a monitor-roof profile to the gable with crows-step detailing to the panelling. The 1940s extension was constructed from Fletton or Brindle bricks and its shallow-profile concrete roof was supported by three concrete beams angled downwards towards the west.

10.3.13Internal Description

10.3.14The primary building comprised seven bays, with six primary roof trusses, and a secondary wall dividing the eastern bay from the rest of the building. This wall towards the east end appeared relatively old but it was not shown on the conversion proposal drawings from 1937 so clearly post-dated these works. Indeed, there is relatively little evidence of the layout of the building either from the original sand furnace phase or from when it was a mess room. Most of the features relate to when it was a workshop or store.

10.3.15Among these were various yellow lines painted on the concrete floor demarcating storage areas – ‘Equipment for Repair’, ‘Keep Clear’, ‘Damaged Parts’, ‘Daily Parts’, ‘Sourced Parts’ and ‘Damaged Goods’. The outline of a former room in the north-eastern corner of the main room was indicated by scars for its ceiling on the east and north walls, and its plastered walls. This former room is not shown on the 1937 plan. Other minor evidence includes a base for a small machine against the north wall.

10.3.16The internal west wall of the main part of the building (*Plate 20.12*) was painted white, above blue. The original windows in the west gable were blocked due to the construction of the later adjoining block, but were almost certainly the same size and height as those in the south wall (as indicated by the 1937 plan). The concrete lintels from these former windows survived, well disguised by the white paint. Two noticeboards, one of them in a glass cabinet, flanked an inserted doorway to the north of the centreline of the west gable.

10.3.17The south wall displayed inset panels (within which the main 20-light windows were set), at the base of which were double-chamfered plinths (*Plate 20.15, 20.16*). Four-light horizontally pivoted opening casements in the centre of these windows were operated by a looped catch at the top that would have been operated by cord. One of these had been replaced by a single pane of glass, within which a motor-driven ventilator had been set. The glazing bars of these windows had a triangular section to the rear (internal) side. At the west end of the south wall a fire door had clearly been inserted into one of these window spaces. There were rendered internal sills, of specially formed sloping bricks. Interestingly, whilst the external jambs of these windows carried an arch, internally the windows had a horizontal concrete lintel. A set of pipes and electrical conduits ran the entire length of the south wall above window height. These connected to large, square, louvred heaters attached to the west wall



- 10.3.18As referred to above there survived two primary windows from the engine shed, towards the west end of the north wall of Structure 20. These had 4 rows of 6 tall lights (much larger than the main windows in Building 20) with metal glazing bars, a segmental arch lintel and a typical sill similar to those in other primary buildings. In the bay to the west of the primary windows was another panel with primary detailing but this one was blind. The sill and panel detailing on this side of the wall is strongly suggestive of this having been an external face of a wall.
- 10.3.19The separate eastern bay contained an inserted floor supported on timber joists held by metal posts (*Plate 20.20 - 20.23*). This was structurally independent from the surrounding walls, and was accessed via contemporary stairs at the north end. A modern door had been let into the east wall of this room. At the north-western corner of this room was a brick flue which measured 0.70m by 0.87m and which post-dated the north-south wall that it abutted. It contained grilles close to floor level, above which on the eastern sidewall were a stack of three steel panels. A square duct emerged close to the top of the flue – a scar on the north-south wall showed that this had vented southwards. The flue structure did not reach as high as the roof of Structure 20.
- 10.3.20The **roof** of the primary building was supported by six trusses formed from full width tie-rods with 'T'-sectioned raking struts (*Plate 20.14*). Vertical tie-rods met the flattened ends of each strut, and their threaded ends passed through a flattened eye in the centre of the horizontal tie rod. The flattened ends and eye were bolted together by nuts on the threaded end of the rod. 'T'-sectioned principal rafters were secured to the struts by riveted plates. Together, the structure was simple and lightweight. The pitches each had two purlins formed from 'T'-sectioned steel carrying timber bearers. The bearer on the lower purlin of the north pitch was slightly offset, possibly because it was supporting a gutter.
- 10.3.21In the 1940s **western extension** there was a sink in the south-eastern corner, a window beside it in the southern wall, and counters by an external door in the western elevation and the internal door into the main space (*Plate 20.24*). The walls were drylined and the floors were covered by office carpet tiles. A third doorway was let into the northern wall. There were three original windows, and these had large sloped brick sills which looked like elements from primary (Edwardian) buildings at the complex and may have been re-used from elsewhere. A narrow fourth window had been let in beside the west doorway, which looked primary but had clearly been widened because the north jamb was a later insert.

Structure 20 Figures

Figure 20.1: Plans from conversion of Sand Furnace in 1937

Figure 20.2: Building 20, Ground floor plan

Figure 20.3: Building 20, south elevation

Figure 20.4: Building 20, north elevation

Structure 20 Plates

Plate 20.1: Western end of Building 20

Plate 20.2: South elevation of Building 20

Plate 20.3: Window in south wall of Building 20

Plate 20.4: East elevation of Building 20



- Plate 20.5: 1940s extension at west end
- Plate 20.6: North elevation (formerly within engine shed)
- Plate 20.7: Eastern end of north elevation (formerly within engine shed)
- Plate 20.8: North elevation (ie formerly internal wall of engine shed)
- Plate 20.9: North side of 1940s extension at west end
- Plate 20.10: North side of window from engine shed
- Plate 20.11: East end within Building 20
- Plate 20.12: West end within Building 20
- Plate 20.13: Roof trusses within Building 20
- Plate 20.14: Roof trusses within Sand Furnace (Building 20)
- Plate 20.15: Internal face of windows within Sand Furnace (south wall)
- Plate 20.16: Internal face of windows within Sand Furnace (south wall)
- Plate 20.17: Sliding doors within north wall of Building 20
- Plate 20.18: North wall within Building 20
- Plate 20.19: Internal face of primary window in south wall of sand furnace
- Plate 20.20: Upper part of easternmost block looking south
- Plate 20.21: Upper part of easternmost block looking north
- Plate 20.22: Ground floor of block at eastern end of Building 20
- Plate 20.23: Ground floor of eastern block
- Plate 20.24: Interior of 1940s block at the west end of Building 20

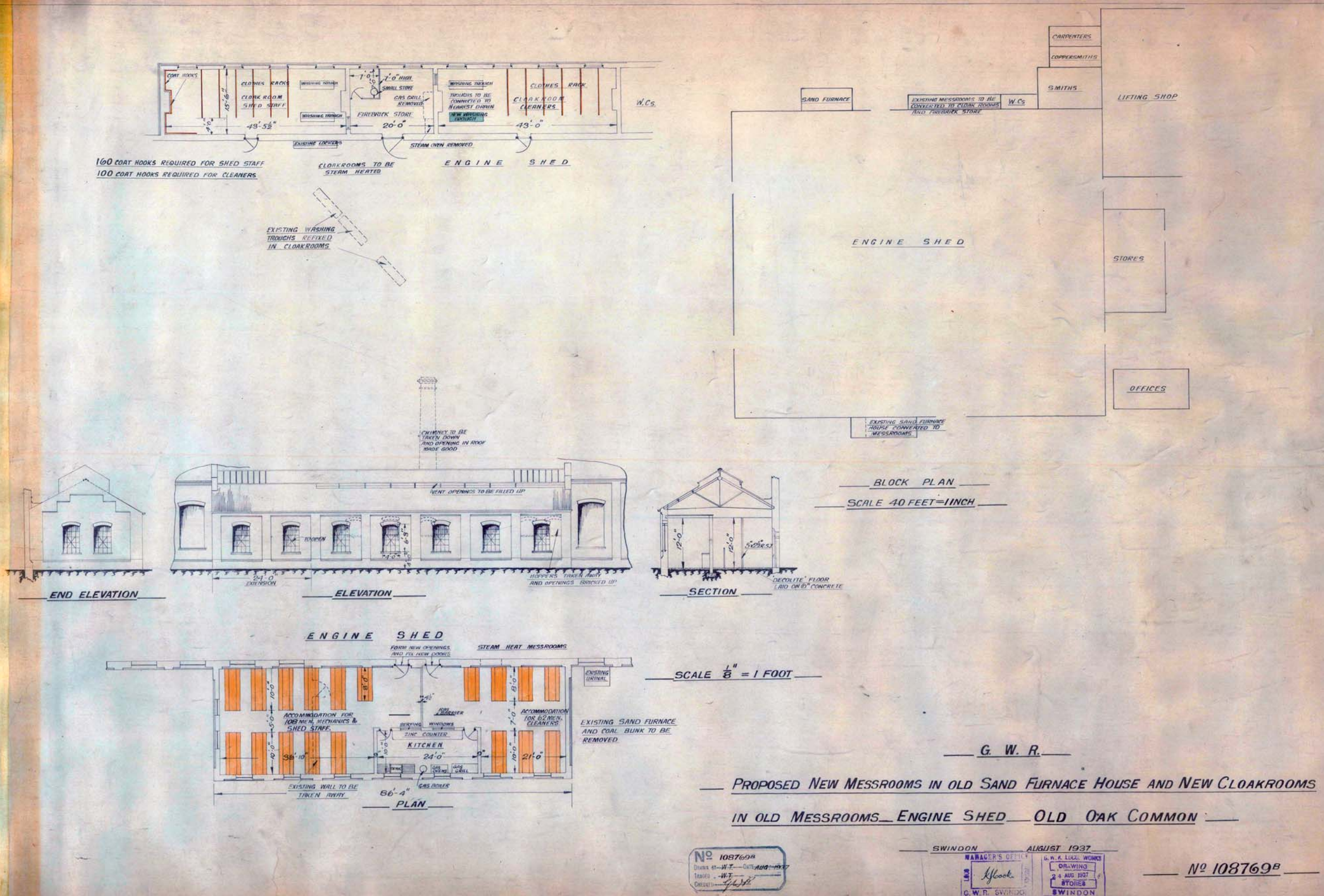

Figure 20.1: Plans from conversion of sand furnace in 1937

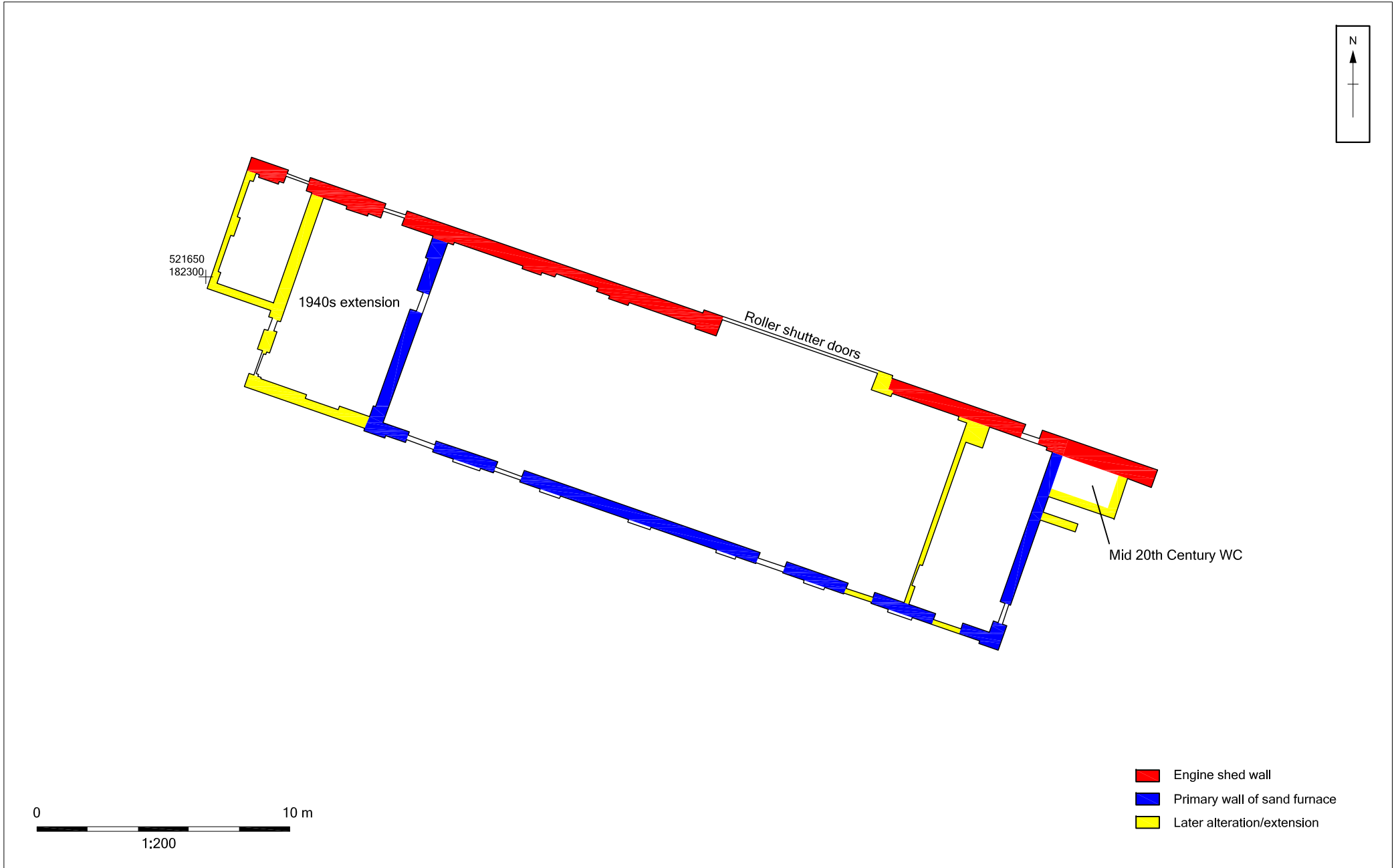

Figure 20.2: Building 20, Ground floor plan

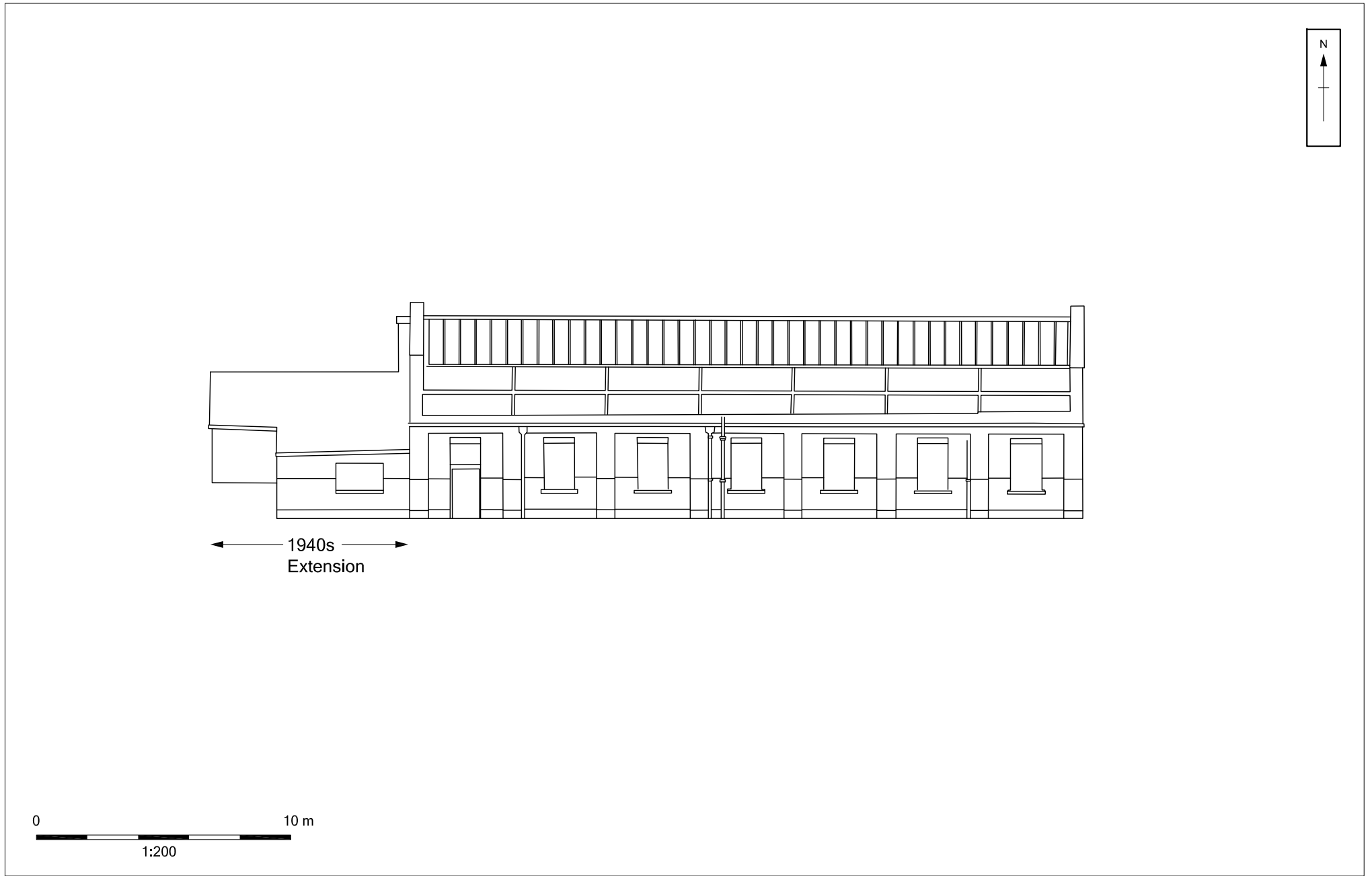
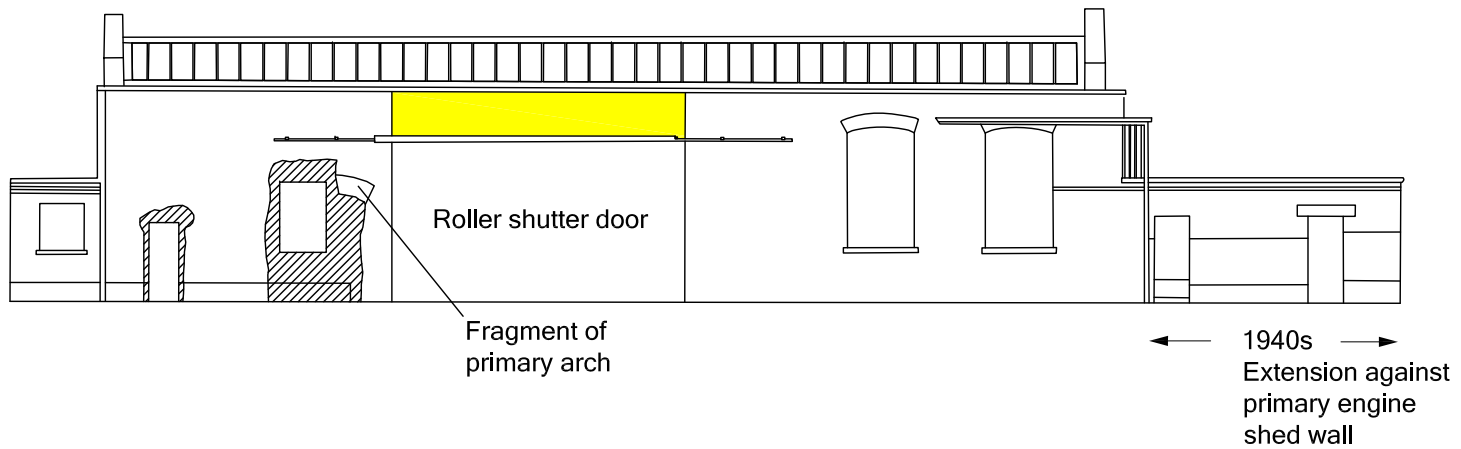
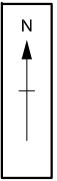

Figure 20.3: Building 20, South elevation



0 10 m
1:200

Concrete block

Figure 20.4: Building 20, North elevation



Plate 1



Plate 2



Plate 3



Plate 4



Plate 5



Plate 6



Plate 7



Plate 8



Plate 9



Plate 10



Plate 11



Plate 12



Plate 13



Plate 14



Plate 15



Plate 16



Plate 17



Plate 18



Plate 19



Plate 20



Plate 21



Plate 22



Plate 23



Plate 24



11. **STRUCTURE 26: ELECTRICITY SUBSTATION B2**

11.1 **Introduction and summary**

11.1.1 This structure sat in the centre of the site, a short distance to the east of the Office/Stores (Structure 16b). The building comprises two clear constructional phases and the older part of the building appears to survive from Churchward's original Edwardian complex (1904-6).

11.1.2 The DDBA assessed this structure as being of regional significance. It has been recorded at EH Level 3

11.2 **History and map evidence**

11.2.1 The original part of Building 26 is shown on a plan of 1906 (Fig 7) and it is assumed to be a part of the original 1904-6 complex. On this plan it is labelled Electric Distributing Centre. The subsequent plans show an identical arrangement up to that of 1966 which labels the building as Sub-Station and shows the southern extension.

11.3 **Description**

11.3.1 Structure 26 divided into two clear distinct phases of construction each of which comprised a rectangular plan building adjoining the other. The earlier build formed the larger rectangular-plan structure (8 x 5 m) to the north while on the south side of this had been added a roughly square-plan extension (5 x 5.5 m). The extension was probably constructed in the third quarter of the 20th century and as mentioned above it is first shown on a plan from 1966. Two transformers were situated to the east of the structure enclosed with modern steel railings. A maker's plate indicated the transformers dated to 2003.

11.3.2 The original building was of red brick laid with a stretcher bond, sat on a deep plinth of blue bricks and a stepped shoulder of two chamfered brick courses. The four corners of the building were all formed from bullnose bricks with attractive stop bricks just below a flat roof – the chamfered shoulder also had bullnosed bricks on the corner. The brickwork was of the same character and same detailing as other primary buildings in the complex (eg Structure 15). The flat roof had a simple boarded fascia (1980s?) which also continued around the secondary extension.

11.3.3 The doorway (*Plate 26.1*) into the original part of the building was set into the western elevation and had a deep concrete lintel. There was a large, steel four-panelled door with iron hinges, set into a steel frame. The heavy oval door handle (*Plate 26.12*) was stamped internally with 'Ratner Safe Co Ltd'. Identical maker's plates were attached to the upper exterior panels and read 'Ratner London'. There were recent soffits and fascias, through which a cast-iron downpipe passed. A cast iron warning sign attached to the southern elevation at chest-height read 'B.R.-W.R. Caution. Buried Electric Cables'. An attractive steel sign reading 'Danger High Voltage' was also attached to the northern elevation.



- 11.3.4 The c.1960s extension tried to match the original (at least superficially), with red stretcher-bond brick above a blue brick band although the newer building was simpler and did not have the chamfered plinth detail or rounded corners (*Plate 26.2, 26.4*). The same fascias and soffits were carried round the extension, but the cast iron downpipe in the angle between the two builds was clearly an original fitting re-used from the earlier building (*Plate 26.3*). Simple square grilles were set into the top-left and bottom-left of the western elevation and the top-right of the eastern elevation. A double door was set into western elevation and had been panelled over with plyboard, now delaminating. A second door was set into the eastern elevation. Both doorsets had thin concrete lintels. On the east elevation the two phases of brickwork were crudely keyed together.
- 11.3.5 Internally, the primary building was a single open space housing a large bank of electrical plant towards the centre (*Plate 26.6, 26.7*). The walls of the original structure were of painted brick (unplastered English bond) and the roof structure was seen to be of cast concrete, the underside attractively shuttered into shallow barrel vaults (*Plate 26.9*). A shallow internal brick arch relieved the primary single door and both the internal and external jambs of this doorway were bullnosed. The steel frame of this doorway was fixed to the brick jambs with large steel screws. Light switches (*Plate 26.11*) were of old brass toggle-type in steel boxes although the lights themselves were relatively modern fluorescent tubes. The floor was a concrete slab although it incorporated steel sheets which presumably covered sunken cable ducts.

Structure 26 Plates

- Plate 26.1: West wall of primary Building 26
- Plate 26.2: General view of Building 26 looking north-east
- Plate 26.3: Junction between original building and later extension
- Plate 26.4: General view of Building 26 from south-east
- Plate 26.5: Detail of plinth brickwork at doorway
- Plate 26.6: Interior of original building looking west
- Plate 26.7: Interior of original building looking west
- Plate 26.8: Lintel above doorway in west wall
- Plate 26.9: Detail of vaulting above primary Building 26
- Plate 26.10: Door jamb detail
- Plate 26.11: Light switch detail
- Plate 26.12: Primary door handle detail



Plate 1



Plate 2



Plate 3



Plate 4



Plate 5



Plate 6



Plate 7



Plate 8



Plate 9



Plate 10



Plate 11



Plate 12



12. STRUCTURE 39: THE MESS ROOM

12.1 Location and summary

- 12.1.1 Structure 39 was a small structure located at the very eastern tip of the site, at its junction with the mainline railway, and it served as a mess room to those working at the remote throat to the yard.
- 12.1.2 As a probable original element of Churchward's depot the DDBA assessed this building as being of regional significance. It has been recorded in the current works at EH Level 3.

12.2 History and map evidence

- 12.2.1 Unfortunately most of the plans of Old Oak Common complex don't extend east as far as the site of Building 39. Therefore map evidence cannot confirm whether it was an original feature. The structure is however shown on the 1914-1916 Ordnance Survey map, and it is very likely to be an original feature of the depot. The DDBA speculates that it may have been associated with the former locomotive yard signal box (now demolished) which was located a short distance to the south.

12.3 Description

- 12.3.1 **Exterior:** This small single-storey building was constructed from red brick and had a rectangular plan with a double-pitched roof. The roof was clad in slate (although many had fallen off when the recording was undertaken) and there were white timber barge boards to each end (*Plate 39.1 - 39.3*). Building 39 comprised two distinct structures: the main primary building and a small outbuilding at the west end.
- 12.3.2 The walls of the main building were laid in a Flemish bond with burnt headers particularly noticeable in the west gable end. There was inconsistent use of blue headers and red stretchers, except on the eastern and western elevations where the effect was of a chequer board. Occasional bricks were stamped 'HAMBLET'S LTD' on the outer face and the bricks measured 7.5 cm x 22 cm x 10.5 cm. In the south wall there was a segmental arched window with a bull-nose brick sill (*Plate 39.4*), whilst the entrance was in the east wall. The doorway in the east wall had a segmental brick lintel (*Plate 39.2*). An ogee cast-iron gutter and downpipe were likely to be original fittings. Much of the south elevation was covered with a thick black paint extending from the east end of the elevation to just beyond the window. A cast-iron ventilator was provided in the gable of the western elevation. The north elevation was featureless and faced onto the embankment wall, 60 cm away.



- 12.3.3 A small brick outbuilding with a single-pitched corrugated iron roof was attached to the western elevation (*Plate 39.1*). This had the initial appearance of being a rough extension but it is also shown on the 1916 map and it was constructed from the same bricks as the original structure and with the same bond. The two buildings are also roughly keyed in so they may be contemporary with each other. The roof of this structure was later and was supported by three east-to-west timbers, two of which also provided the wall plates to the northern and southern elevations. There was a simple, single door opening in the southern elevation and a brick-paved floor. Fitted timber shelves showed it had been used as a storeroom.
- 12.3.4 **Interior:** The interior of the main building was divided into two very unequally-sized rooms by a north-to-south aligned brick wall and a door, and a timber tongue and grooved studwork return and door. The southern end of the wall was formed from bull-nosed bricks. Two coat hooks on a wooden plate were attached to the southern side of the studwork – the hooks looked to be original fittings. The doors to this room and the main room were both original and constructed from timber in a traditional four-panelled design. There was a little wall-mounted boiler in the small room and a high shelf (*ie* above door height) on the north, south and east walls. Electric lighting and power outlets were powered by metal conduits screwed to the internal walls and false ceiling. Much of the interior was painted white.
- 12.3.5 The roof structure was of narrow timber boards over rafters supported by several collar beams. The main room was originally open to this roof structure, but a more modern ceiling with timber joists had been inserted; the smaller room retained its original ceiling. The main room had a small, interestingly stepped chimney breast with a brick infilled fireplace in its north-western corner. The design of the chimney breast was reminiscent of an example in the Stores building. A tall brick chimney on the north-western corner of the building is shown in 1959.
- 12.3.6 Two undated plans of the oil gas main arrangements in the yard (WSHC 2515 410 0359 and 2515 410 0425(2)) identified the hut as 'P.W H', perhaps meaning 'Permanent Way Hut'.

Structure 39 Plates

- Plate 39.1: South elevation of Building 39
- Plate 39.2: Building 39 from south-east
- Plate 39.3: Building 39 from south-west
- Plate 39.4: Window in south wall of Building 39
- Plate 39.5: Door at east end of Building 39
- Plate 39.6: Detail within Building 39
- Plate 39.7: Old boarding within Building 39
- Plate 39.8: Blocked fireplace in Building 39



Plate 1



Plate 2



Plate 3



Plate 4



Plate 5



Plate 6



Plate 7



Plate 8



13. STRUCTURES 6 AND 53: HEAVY OIL FUELLING DEPOT (DIESEL/OIL) PUMPHOUSE, BUNDED WASTE OIL AND DIESEL OIL TANKS

13.1 Introduction and summary

- 13.1.1 This pair of structures was located along the northern edge of the site to the north-east of the Factory (Structure 15). The diesel oil pump house is Structure No.6 while the adjacent bund is Structure No. 53.
- 13.1.2 The DDBA assessed that these buildings were potentially the most significant structures at the Old Oak Common site, being of regional to national significance. This was despite them not being part of the original Edwardian complex and only having been erected in 1946/7.
- 13.1.3 The DDBA felt that they were particularly significant due to the structures' being associated with two important secondary periods in the site's history. They were originally constructed during a period of austerity that followed the Second World War as part of a heavy fuel oil storage depot. It was used by a small number of coal fired locomotives which were converted in this period to run on oil due to the coal shortages of the time. The second, relatively short period with which these two structures were associated was from 1949 when the depot was remodelled as a fuelling plant for two experimental gas turbine electric locomotives. Following the abandonment of this experiment by the late 1950s these two structures continued to be used as a diesel fuel depot.
- 13.1.4 Due to the significance of the buildings they have been recorded at EH Level 3.

13.2 Historical background and map evidence

- 13.2.1 The 1906 site plan (Gen Fig 7) confirms that at this date Structure 53 had not yet been constructed although there was a pump house in this general vicinity (apparently slightly to the north of Structure 6). The 1930 plan (Gen Fig 8) shows a filter house in this area and the 1931 shows a slightly larger structure here. Several plans from the later 1930s and early 1940s suggest that in this period this area was relatively little used although there were several proposals for developments which were not undertaken.
- 13.2.2 As detailed in the DDBA the oil fuelling depot and pumphouse were constructed in 1946/7 as part of initiatives in the immediate post-war period to make the most efficient use of the country's limited fuel supplies and to reduce the railway's dependence on coal. General fuel supplies for domestic, industrial and transport use had become depleted and in order to try to maintain coal supplies the big four railway companies each launched initiatives to convert coal-fired locomotives to run on oil. In the spring and summer of 1946 the GWR converted a series of locomotives to run on oil and oil fuel storage tanks were set up at a number of depots, including at Old Oak Common. Plans for the new oil fuelling tank at Old Oak Common, on the site of an old coal stacking ground, were drawn up in Sept 1946. These plans show two vertical, heavy fuel oil tanks each with a capacity of 176,000 gallons as well as a boiler house



to drive the steam pumps in the pump house (ie Building 6). The boiler house was to be immediately west of Building 6.

- 13.2.3 In the later 1940s the GWR was also undertaking experiments into gas-turbine locomotives in order to reduce their reliance on coal, and this was also closely linked to Structures 6 and 53 at Old Oak Common.
- 13.2.4 In 1946 the GWR board had authorised the acquisition of a prototype gas-turbine electric locomotive, to be run on heavy fuel oil, although this was not delivered until after the nationalisation of the railways in 1948. Plans were then drawn up in March 1949 to convert the 1946-7 heavy oil depot at Old Oak Common into a dedicated gas turbine locomotive fuelling facility (Fig 53.2). The proposal was to replace the westernmost vertical oil tank with a pair of 30ft x 9 ft horizontal tanks, reused from Didcot, which would store the heavy oil for the gas turbines. It appears from later plans that only one of these horizontal tanks was actually fitted. The tanks were to be connected by pipes to the boiler house and pump house to the east of this complex.
- 13.2.5 The experiment to introduce gas-turbine locomotives does not appear to have been as successful as initially hoped and only two locomotives were ever brought into service by British Railways (No. 18000 and 18100).
- 13.2.6 Information from Wikipedia suggests that BR18000 was the prototype initially ordered in 1946 from Brown, Boveri & Cie and then delivered in 1949. This locomotive was withdrawn from service in England in 1960 although it was subsequently reused (in much altered form) on the continent. In the early 1990s it was secured for preservation and it is understood to now be at the Didcot Railway Centre. BR18100 was constructed in 1951 by Metropolitan Vickers of Manchester and was a different model to 18000. It was withdrawn from service in 1958.
- 13.2.7 In c.1960 the plant at Old Oak Common was remodelled again to allow for the servicing of diesel locomotives and these proposals are shown on a plan of September 1960 (Fig. 53.1). This plan shows that the boiler house which was immediately to the west of Building 6 had either already been demolished or what to be removed in the proposed works. It also shows that the low walls of the compound/bund were to be altered and that the existing vertical heavy oil tank was to be converted for light oil storage. It is interesting to note that the one vertical tank on the western base was to be retained as a heavy oil tank for gas turbine locomotives. This appears to support the evidence on Wikipedia that suggests that in 1960 there was still at least one gas-turbine locomotive operating.

13.3 Description

13.3.1 This complex of structures comprise a series of elements, the main ones of which are:

- a small rectangular plan pump house to the east (Structure 6)
- a tall vertical cylindrical tank to the west located with a bund or compound formed by a low wall (Structure 53).



- 13.3.2 In addition the complex also includes a series of associated plant such as pumps to the east of the pumphouse (*Plate 53.1*), numerous pipes, some of which extend west away from this group (*Plate 53.10*), and a tall vertical jib for unloading diesel oil (*Plate 53.1*).
- 13.3.3 The **pumphouse** (Structure 6) was a single-storey, roughly square plan (7.25 x 7.25 m) building constructed of red brick in stretcher bond. The walls were surmounted by a heavy concrete wall plate containing ventilation bricks which carried a cast reinforced concrete roof of very shallow double-pitch (*Plate 6.1*). A former doorway with a concrete lintel was situated in the northern elevation – this had been infilled with Fletton bricks (*Plate 53.5*). The north-western corner of the building had been rebuilt in a different brick and this probably related to the demolition of the former boilerhouse which was constructed in c.1946/7 and formerly adjoined to the west side of the building.
- 13.3.4 The western elevation was divided between the southern half, of the same red brick as the main build, and the northern half, of later light grey ‘bricks’, possibly actually of concrete (*Plate 53.9*). The later brickwork in this elevation also clearly related to the former boiler house which adjoined the building at this point. This secondary section of wall contained a pedestrian doorway with a concrete lintel with a simple, vertical-board door. The division between the two brick types was marked a pier of 0.40m width and of the same brick as the replaced north-western corner.
- 13.3.5 The southern elevation (*Plate 53.3*) contained a double-door towards the west end with a concrete lintel and two doors of the same type as the northern elevation. The eastern elevation contained two tripartite windows, each with a concrete lintel (*Plate 53.1*). The outer parts of the timber windows were divided into three vertical lights and the central one had a low light beneath a casement.
- 13.3.6 The interior of the pumphouse comprised a single open-plan room with painted brick walls, brown to the lower half, white to the upper half (*Plate 53.12*). The concrete roof was hidden by a plasterboard ceiling fixed to battens. There were two voids in the floor of 0.75m x 1.50m size and 0.8m depth and a central internal east-to-west concrete beam, with stop chamfered edges, to support the roof. Switchgear and other electrical apparatus, plus noticeboards and an electric fuel level gauge, were fixed to the internal side of the western wall (*Plate 53.15*).
- 13.3.7 A well-preserved network of pumps, pipes and valves were situated against and in front of the eastern elevation of Structure 6. Two valvesets on concrete bases survived – another two bases suggest others had been removed. Castings on two of the valves show they were made by ‘Plenty’, an engineering company established in Newbury in 1790 who latterly specialised in pumps and were acquired in 2001 by SPX. A feed pipe into the valves extended eastwards for perhaps 50m, to the immediate north of which was a siding. Regularly-spaced flanged valvegear in this pipe suggest that oil tankers would have been discharged from this siding. At the north-eastern corner of the pumphouse is a tall vertical pipe bolted to the floor and this is shown on the 1949 plan, labelled as a diesel oil unloading point.



- 13.3.8 The **bunded waste oil and diesel oil tanks** (Structure 53) were located immediately to the west of the pumphouse. This structure number comprises the fuel oil storage tank, associated pipework, and the bund that contained them. The concrete ground surface within the bund was lower than surrounding ground levels and had been cast in 4m x 6m bays with a very thin joint between them. The bund was formed from yellow stock brickwork, bonded with cement mortar in English bond, to a height of 15 courses from internal floor level and surmounted with a concrete block parapet. This brickwork appears to be later than the base of the tank itself and probably dates from the c.1960 modifications. A 0.2m deep, 1m wide trench was situated against the external elevation of the north wall, set into the concrete apron that ringed this side of the bund.
- 13.3.9 An octagonal brick base inside the bund supported a large, cylindrical oil tank, apparently surviving from the 1946-7 establishment of this complex. This base was ten courses tall, topped by a brick soldier course. All bricks were of red stock, laid in English bond and were earlier in date than those in the wider bund wall. The walls contained a mass concrete base for the tank, finished to the top of the soldier course. There was a large valve and associated pipework in a recess on the southern side of the brick base that was fed from the base of the tank. A secondary pipe and valve – all heavy duty – entered the base of the tank on its northern side. This pipe, suspended above the floor of the bunded area, emerged through the east wall of the bund, passed to the north of the pumphouse, turned at the north-eastern corner and passed under the ‘Plenty’ valvegear described above.
- 13.3.10 The tank was painted grey and had been fabricated from rectangular welded and riveted curved panels, to six lifts in height. An external spiral staircase of steel wound up the southern side of the tank from the western side. This had two intermediate landing stages. The tank was crowned with a simple post and double-rail fence, again of steel. This was as it was depicted in a photograph of 1964 (Leigh 1993, 76), although then it was painted black. A cylindrical inspection entrance into the tank was situated at the foot of the staircase. Both were accessed from the floor of the bund by a short flight of concrete steps. The bund itself was accessed by a simple steel stile at the south-eastern corner.
- 13.3.11 A small sign attached to the external north-eastern corner said ‘Diesel Fuel Oil Offload’. Inside this corner of the bund there various pipes and valves, largely not *in situ*, and mounted switchgear and control panels. Other pipework was mounted overhead, to carry pumped fuel from the pumphouse towards the main body of the site. This pipework was supported either with slender brick columns or cylindrical steel columns mounted on concrete pads carried on square brick plinths.

Structure 53 Plates

- Plate 53.1: Pumphouse from east with tank behind
- Plate 53.2: Pumphouse and tank from south-east
- Plate 53.3: South side of pumphouse and tank behind
- Plate 53.4: East side of pumphouse with diesel unloading jib
- Plate 53.5: North side of pumphouse
- Plate 53.6: Bund and tank from north-east
- Plate 53.7: North side of tank
- Plate 53.8: General view from east



- Plate 53.9: West side of pumphouse showing infilled wall
- Plate 53.10: Pipes extending west from complex
- Plate 53.11: Ex-situ plant in bund
- Plate 53.12: Interior of pumphouse looking north-west
- Plate 53.13: Interior of pumphouse looking south-west
- Plate 53.14: Interior of pumphouse looking east
- Plate 53.15: West wall inside pumphouse
- Plate 53.16: North end of west wall of pumphouse



Plate 1



Plate 2



Plate 3



Plate 4



Plate 5



Plate 6



Plate 7



Plate 8



Plate 9



Plate 10



Plate 11



Plate 12



Plate 13



Plate 14



Plate 15



Plate 16



14. STRUCTURE 1: SHUNTERS CABIN

14.1 Introduction and summary

14.1.1 The shunter's cabin was situated at the east end of the complex, where the site narrows to a throat, and it was beside the foot of the embankment to the Grand Union Canal to the north. The DDBA assessed this building as being of local significance due to the number of other surface air raid shelters known to survive locally and nationally. It has been recorded in the current project at EH Level 2.

14.2 History and map evidence.

14.2.1 This building was probably originally constructed during the early stages of WWII to function as a surface air raid shelter and to offer protection to staff working the remote eastern end of the site. The adjacent embankment would have provided an element of blast protection. In contrast the other air raid shelters along the northern and western boundaries of the complex were buried. It is depicted on a GWR survey drawing of September 1943. It is also shown in the background of an image taken in 1959 contained on page 8 of *The Heyday of Old Oak Common and its Locomotives* by Chris Leigh.

14.3 Description

14.3.1 This thin, rectangular-plan, single-storey building was constructed from red engineering brick in English Bond except for the northern wall, which was of concrete block construction. The walls had been roughly painted black, probably during the Second World War.

14.3.2 The shallow double-pitched roof was also formed from rough concrete (large chips), with transverse shutter marks clearly visible internally. Two cast-iron vent pipes projected out of the west half of the roof (*Plate 1.2*). A thick, 'L'-shaped rendered brick blast wall covered in the remains of a concrete render protected an original door, which was set in the eastern elevation. All that remained of this low, infilled opening was the concrete lintel.

14.3.3 The south elevation (*Plate 1.1 - 1.3*) contained three windows with concrete jambs, Crittal-type steel window frames and sills of brick set on edge at a slight gradient to shed water. All three windows were of different size. The easternmost was of six-pane, double casement design, with one casement opening. The central window was deeper and wider, and the westernmost window shallower and wider. The 1959 image referred to above shows that the westernmost window had a three-casement window with single panes. All the extant openings post-dated the use of the building as an air raid shelter, and dated from its conversion into a worker's cabin, probably shortly after the end of the war.

14.3.4 There were doors on the southern side of the western elevation and the eastern side of the southern elevation. The latter was set in a timber frame within concrete jambs. The timber door in the west elevation was not protected like the door at the east end of the building and was almost certainly a post-war alteration.



14.3.5 There were two main rooms inside the shelter. The eastern room had been heated by a stove in the north-eastern corner, the enameled chimney for which survived. A second flue projected from the southern edge of the roof immediately to the west of the westernmost window. This had replaced a low brick chimney, as captured in 1959. Neither stove survived. A single metal-cased power conduit was attached to the central underside of the ceiling. This was controlled by a push-button metal switch attached to the jamb of the door in the southern elevation.

Structure 1 Plates

- Plate 1.1: Shunters Cabin from south-west
- Plate 1.2: South side of Shunters Cabin
- Plate 1.3: South side of Shunters Cabin
- Plate 1.4: Shunters Cabin from south-east
- Plate 1.5: Interior of Shunters Cabin
- Plate 1.6: Interior
- Plate 1.7: General view in Shunters Cabin
- Plate 1.8: General view inside building



Plate 1



Plate 2



Plate 3



Plate 4



Plate 3



Plate 4



Plate 5



Plate 6



15. **STRUCTURE 22: PULLMAN SHED (FORMERLY THE CARRIAGE SHED, PAINTSHOP AND THE ELECTRICAL SHOP,)**

15.1 **Introduction and summary**

15.1.1 The Pullman Shed was the longest building at Old Oak Common and was located towards the south-western corner of the site. It faced onto the main, sloped approach road into the site and the western end of the building was cut into this slope. It was built in 1939/40 as part of a government-backed railway works programme covering the four principal railway companies. It stands alongside the contemporary and similarly constructed Carriage Lifting Shop (Building 23).

15.1.2 The DDBA assessed this building as being of regional significance. The building has been recorded at Level 2.

15.2 **Outline history and map evidence**

15.2.1 The 1906 site plan does not appear to show any buildings on the site of the Pullman Shed (although this area is not fully detailed as it is outside the main part of the original complex). There also does not appear to be any significant structures in this area on any of the other pre-World War Two plans although Ordnance Survey maps do show a vast Carriage Shed further to the south (outside the current Old Oak Common footprint) surrounded by sidings.

15.2.2 There are a number of drawings from 1938 detailing the proposed construction of the new Carriage Lifting Shop (Building 23) and the Painting Shop (Building 22). These drawings include plans, sections, elevations and foundation details (see *Fig 22.1*). There also survives another plan from 1959 detailing the conversion of the paint shop to a building for Diesel Pullman Maintenance.

15.2.3 Most of the post-war site plans seen in the current project again focus on the historic centre of the Old Oak Common complex around the engine shed and they only show the northern edge of the Pullman Shed. The main exception is the plan of 1966 (Gen Fig 13) which shows the footprint of Building 22 labelled as the Diesel Pullman Maintenance Shop.

15.2.4 The building is known to have suffered bomb damage during the Second World War. The DDBA reports that in 1940 there was a day-light raid on the depot when at least one 500 lb bomb fell on Structure 22 (TNA RAIL 253/309) causing damage to the roof and the south-east gable end. A number of carriages inside the building were damaged and the DDBA includes three photographs (Plates 1-3) showing the damage caused to the east end of the building. A plan from October 1959 (2515/410/0690) shows proposals to convert the Carriage Paint Shop to use as the Diesel Pullman Maintenance shed.

15.3 **Description**

15.3.1 **External Description**

3



- 15.3.2 The Pullman Shed was a long, single storey building with a rectangular plan (181 m x 22.5) and it ran parallel to the adjoining, and slightly taller Carriage Lifting Shop (Building 23). The building had a steel structural frame although the wall stanchions were encased in concrete and this was expressed externally, with light brown/beige brick to the panels. The building had a gabled roof clad in corrugated sheeting and each slope of the roof had two full length roof lights as well as two walkways with railings. The roof lights appeared to be primary.
- 15.3.3 The **north elevation** (*Plates 22.1- 22.6*) faced the main access road into the site and had a standard repeated form of 48 bays divided from each other by a series of concrete posts encasing steel stanchions. A similar concrete beam spanned between each post three quarters of the overall height of the elevation and above this there was a brick parapet of 18 bricks. The main bays had primary, 20-light metal-framed windows (five rows of four lights) but the lower two rows of the window in Bay 15 were blocked up. The middle four panes of the upper two rows of these windows opened, and were hinged on their central axis. Here there was a door that re-used as its lintel the original sill from the window. Bays 11 and 13 had been bricked up, Bay 12 similarly (this also had a bricked-up door beneath). But Bay 1 and Bays 3 to 10 remained as primary windows. In Bay 2, the window was formed of only three rows of four panes, and the panes were squatter than those of the other windows of this elevation. This left room beneath for a plain door with a concrete lintel. Bay 16 contained roller shutter doors – the window above was the same as that in Bay 2, suggesting that there was a primary doorway beneath. This window had a primary sill, but the brickwork beneath had been replaced, presumably at the same time as the roller shutter door was inserted.
- 15.3.4 Bay 17 of the northern elevation displayed two primary doors to the lean-to, and a high primary window. Bay 18 also contained a high, primary window. There was an inserted door in Bay 19 – the former window has been blocked although the sill was still *in situ*. Bays 20 to 32, 34 to 45 and Bay 47 displayed their original 20-light windows, and in Bays 33 and 46 there was a primary 12 light window above primary doors, that in Bay 33 being marked as a fire exit. In Bay 48 there was a small, tall primary window by stairs – Bay 49 was in a room. The western half of the north elevation was relatively unobstructed, although partly hidden by the adjacent bank, but towards the east end there were a number of small simple extensions and projections.
- 15.3.5 The western of these was a partially primary WC (*Plate 22.6*) block with a lean-to roof. The eastern two-thirds of this structure was primary (peach/beige brick) but the western one third was an extension formed from a more red brick. The primary part overlay two bays in the main building and in each of these there was a small higher primary window just beneath the concrete wall plate. The secondary part of this extension, which formed a cleaners cupboard and appeared to be an early alteration (1940s-50s) abutted tall primary windows.
- 15.3.6 To the east of the WC block was another similarly sized lean-to which is not shown on the original plans of the building and was a secondary extension (*Plate 22.2*). It appeared to be contemporary with the the western third of the other lean-to (red brick) and it overlay three primary windows. To the east of this there was another low



compound with two tall tanks and adjacent to this was another small modern structure constructed from pre-fabricated panels.

- 15.3.7 The eastern end of the north elevation had been partially reconstructed following Second World War bombing (discussed further below) and this was visible in the use of a slightly different coloured brick.
- 15.3.8 The **south elevation** of Building 22 was largely obscured by the adjoining Lifting Shop (Building 23) but the easternmost 15 bays (*Plate 22.9*) were external and were very similar to the bays in the north elevation. They had the same arrangement of concrete posts, beams, parapet and primary 20-light windows although Bay 2 had a primary door with 12-light window. In Bay 15, the insertion of a door had required the removal of the lowest row of lights. Similarly to the north elevation, the eastern end of the south elevation had been partially reconstructed with a more grey beige brick following war-time bomb damage.
- 15.3.9 The **east elevation** was a prominent feature of the Old Oak Common complex as it faced onto a large open part of the yard. The elevation comprised three large openings at ground floor to allow for three sets of tracks (roads) to enter the building. Each opening had vertically sliding roller shutter doors and to either side of each opening there were two large stone blocks built into the brickwork which would formerly have supported the hinges of the original double doors. The inner faces of these jambs had blue bullnose corners (now painted) and 'stop-bullnose' bricks at the height of the lower hinge stone (c.2 m high).
- 15.3.10 The gable end above the concrete lintels was formed from a slightly different coloured brick (grey beige) to the original pink/beige which was used in the main long elevations and in the piers of the east end. The south-east corner of the building was also constructed from the more grey coloured brick and it seems highly likely that the differences at this end of the building are due to rebuild after Second World War bomb damage. As mentioned above it is known that this end of the building suffered wartime bomb damage and required some reconstruction.
- 15.3.11 The upper part of the gable is also divided into three by two vertical piers aligned with those at ground floor and it is interesting to note that the original plans of the building (see *Fig 22.1*) show a large circular bulls-eye window towards the apex. This circular window is again shown on the plates in the DDBA which show the building after the air raid, but it does not appear to have been included in the rebuilt gable and there was no evidence of the window when the building was recorded in 2010.
- 15.3.12 The **west elevation** (*Plate 22.7*) was far less prominent than the east elevation because it faced into a bank but this end of the building remained very close to its primary form. The elevation was gabled with three recessed panels to the upper section of the gable although unlike the partially rebuilt east elevation this end of the building retained its central bulls eye window. The lower half of the elevation had a row of five, 8-light metal framed windows at first floor, above a similar row of primary windows at ground floor. Each of these had concrete sills and lintels and the upper four lights were horizontally pivoting hopper lights.



15.3.13 Internal description

- 15.3.14 The interior of Structure 22 was very largely a single vast open space, open to the roof and with three roads in the concrete floor. The tracks of the northern road extended the full length of the building, up to the narrow two-storey block of rooms at the west end, although other than the easternmost section this road had been infilled prior to the 2010 recording. The south road (Road 4) extended west as far as the former air raid shelter (detailed further below) although it had again been filled. The tracks were still visible and the buffers on this road remained *in situ*. The central road (Road 5) was the same full length as the northern one and at the time of the 2010 recording it remained open in the eastern three-quarters of the building. The open section had inspection pits with lights similar to those in Building 15.
- 15.3.15 The main **south wall** of Structure 22 was shared with the adjacent (and contemporary) Building 23 and comprised a huge girder set high up with a light-weight partition beneath clad in corrugated cladding which was either primary or an early addition (*Plate 22.24*). The main girder was formed from an steel 'I' beam with intermediate vertical braces rivetted to the side. This was supported by steel posts at every third truss. The frame that supported the cladding was formed of lightweight vertical and horizontal members with simple 'L'-shaped brackets. Four horizontals – one at sill level, one at the top just below the main girder, and two intermediates. The verticals aligned in each bay with the trusses.
- 15.3.16 In this wall there were a series of sections where the cladding had been replaced and these may have formerly been openings. This cladding could be seen to be a later work because it was fixed with square-headed fixings whilst the earlier cladding was fixed with circular fixings and washers. One such section was at the east end and this appeared to be secondary but there were a further six openings in the cladding west of this point and these appeared to be primary. Each of these openings had simple pintle hinges on each jamb to support former doors.
- 15.3.17 One of the interesting features of the building in relation to its former use was a set of eight pipes with lagging, fixed by large brackets to the north wall and extending virtually the full length of the building (*Plate 22.18*). These were all fixed to the upper half of the wall, above the windows, and it is believed that they were used to dry the painted wagons from when this building was originally the Painting Shop. In addition there were also three further pairs of long pipes suspended from the trusses with a metal shield directly over each pair to reflect the heat down into the building (or onto the newly painted trains). In addition the pipes along the north wall linked to another set of heaters suspended from the trusses and set between the roads. These were large metal boxes with numbers on and they had louvres to control air flow. The numbers seemed to start at 35 at the east end and they climbed up to 66 towards the west.
- 15.3.18 The **roof** of Structure 22 was supported by 48 lightweight steel trusses typical for the mid 20th century (*Plate 22.16*). Each truss was constructed from L-section steel members joined by rivetted steel connecting plates. Each truss had seven vertical struts and six raking struts, together with principal rafters and tie-beam. The vertical struts were formed from single L-section steels while the other main members were formed from coupled pairs of L-section steels. There were three timber purlins to each



slope supporting the raised roof lights as well as L-section steel purlins onto which the cladding was fixed. The north ends of the trusses were supported by a steel plate in the wall which was itself supported by principal stanchions every third truss. The south end of most trusses were supported by the large steel girder in the wall between Structure 22 and 23 which is also supported by stanchions every third truss.

15.3.19 Some of the trusses were panelled (cement paste panels) to form bays, far more so in the east half of the building than the western half. The trusses thus panelled were 4, 7, 10, 13, 16, 19, 22, 25, 34, 37, 43 and 46 (counting from the east). These panelled sections corresponded with large overhead heaters, all of which had been individually numbered, and were serviced by large-diameter overhead pipes which had been clad. Truss 25 had deeper panels, extending below the tie beam to a separate frame. This, in effect, split Structure 22 into two halves. Between Trusses 21 and 22 there was a large extraction hood (c.3 m x 1.75 m) in the shape of a funnel over the central track. Another extractor was situated between Trusses 19 and 20, this time of square section, not a hood.

15.3.20 A curious quirk was that some of the primary windows – ie in Bays 21 to 24 and the windows in both sides of Bay 2 - appeared to have been fitted backwards, made apparent by the fact that the remainder had flat-faced Crittal-type bars on the inside and 'arrow'-shaped bars to the outside. It is significant to note that each of the opening windows in these 'reverse' examples had been welded shut, to prevent the logical consequence, of rain pouring in should they have been opened. There were various isolators and pieces of electrical plant along the east wall while there was another large bank of isolators was fixed on the south wall

15.3.21 At the west end of Structure 22 was a **two storey set of offices** adjacent to the open-plan hall (*Plates 22.6-22.8*). The character of this area suggests that the ground floor housed various workshop functions and a simple mess room while the first floor had higher status offices and a balcony overlooking the main hall. The east face of the east wall (facing the hall) had many fuse boxes and electrical gear fixed to it.

15.3.22 An overlay plan from 21 November 1940 (2515/403/0361) shows proposal drawings which suggest that the ground floor of this block was converted to a sleeping shelter (ie air raid shelter). The date of this plan suggests that the works must have been undertaken shortly after the 500 lb bomb which fell on the paint shop and was probably part of the rebuilding works. The DDBA does not state the exact day that the bomb fell but it does mention another raid on 24th September 1940 and then adds that 'just over a month later' the bomb fell on the paint shop (TNA RAIL 253/309). The drawing shows that the converted ground floor area would have comprised two main rooms of similar size to each other with a smaller mess room at the south end. The building would have provided 96 bunks and the works would have included the addition of new RSJs to supplement the existing beams and strengthen the ceiling. A new wall would have been added to the east side together with baffle walls to protect the entrances.

15.3.23 At the time of the recording in 2010-11 the layout of the ground floor area still partially reflected the 1940 arrangement when it was an air raid shelter, although a



secondary partition had been inserted into the main southern sleeping shelter. The rooms had exposed ceilings with concrete beams and RSJs ('Earl of Dudley Steel') which were almost certainly the secondary beams added in 1940 during the conversion works. These beams were supported at their east end by brick piers in the painted brick wall (not plastered). The RSJs were supported by an intermediate steel post but it was off centre to the west (shown on the proposal drawing). The floor in the northern room was concrete to the west half but boards to the east half while the floor in the southern room was entirely covered in thick boards. There were telescopic shutters (like an old lift) over the entrance to the central room. There was a blocked door in the west half of the north wall of the north room (ie the external wall)

15.3.24 The first floor of this block was reached by a simple flight of open-tread, north-to-south steps adjacent to the hall. The balcony had a cornice to the main painted brick wall and largely appeared to retain its primary arrangement of windows and doors. To the west of the balcony the first floor was divided into seven rooms generally with plastered walls, tongue-and-groove boarded ceilings, skirting and simple cornice. The southernmost room has a primary 8-light window in its south wall, similar to those in the west wall, which overlooked the hall in the adjacent Carriage Lifting Shop (Structure 23). The northernmost room is a ladies WC and is one of three small rooms at this end of the block which seem to have been converted from a single previous large room.

15.3.25 Towards the western end of the building there was a **detached single-storey structure** (Plate 22.25) against the south wall adjoining the Carriage Lifting Shop. This rectangular plan structure (30 m x 6.5 m) had painted brick walls and a concrete slab roof supported by RSJs. The walls were formed from single skin brickwork with piers for strengthening and there were windows with concrete lintels. In its eastern room there was a window in the north wall, lots of vents and a clocking in/out machine. The middle room contained a workbench and two windows in the north wall, and in the adjacent room three windows in the north wall, a linoleum floor covering linoleum tiles, and a little sink. Rooms to the west contained toilets. This structure is not shown on the original plan of the building (2515-403-0360) and there is some uncertainty as to when it was added. The DDBA suggests that it was probably added when the building was converted to Diesel Pullman Maintenance (c.1959-60) although it is possible that it was added earlier.

Structure 22 Plates

- Plate 22.1: North elevation of Building 22
- Plate 22.2: Towards east end of north elevation of Building 22
- Plate 22.3: North elevation of Building 22 viewed from east
- Plate 22.4: Towards central section of north elevation of Building 22
- Plate 22.5: Eastern end of north elevation of Building 22
- Plate 22.6: Partially primary lean-to on north side of Building 22
- Plate 22.7: West elevation of Building 22
- Plate 22.8: North-west corner of Building 22
- Plate 22.9: East end of south elevation of Building 22
- Plate 22.10: West end of north elevation of Building 22
- Plate 22.11: General view of interior looking east
- Plate 22.12: East end of interior
- Plate 22.13: Interior looking north-east



- Plate 22.14: General view of interior looking west
- Plate 22.15: Interior looking west
- Plate 22.16: Roof trusses and vents looking west
- Plate 22.17: Roof trusses and vents looking west
- Plate 22.18: North wall of Building 22 with heating pipes
- Plate 22.19: Trusses and vents in roof
- Plate 22.20: General view looking east
- Plate 22.21: General view looking east
- Plate 22.22: Interior looking south-west
- Plate 22.23: Looking west at buffers
- Plate 22.24: South wall adjoining Building 23
- Plate 22.25: Detached building possibly added c.1960
- Plate 22.26: Offices at west end
- Plate 22.27: Offices at west end
- Plate 22.28: Offices at west end



Plate 1



Plate 2



Plate 3



Plate 4



Plate 5



Plate 6



Plate 7



Plate 8



Plate 9



Plate 10



Plate 11



Plate 12



Plate 13



Plate 14



Plate 15



Plate 16



Plate 17



Plate 18



Plate 19



Plate 20



Plate 21



Plate 22



Plate 23



Plate 24



Plate 25



Plate 26



Plate 27



Plate 28



16. **STRUCTURE 23: LIFTING SHOP (FORMERLY THE CARRIAGE LIFTING SHED)**

16.1 **Introduction and summary**

16.1.1 The Lifting Shop was a long building located towards the south-western corner of Old Oak Common which stood adjacent to the longer, but lower, Pullman Shed (Structure 22). It was built in 1939/40 as part of a government-backed railway works programme covering the four principal railway companies.

16.1.2 The DDBA assessed this building as being of regional significance. It has been recorded at EH Level 3 in the current project.

16.2 **Outline history and map evidence**

16.2.1 Map evidence suggests that there were no significant structures in this area prior to the 1930s although Ordnance Survey maps do show a vast Carriage Shed further to the south (outside the current Old Oak Common footprint) surrounded by sidings.

16.2.2 There are a number of drawings from 1938 detailing the proposed construction of the new Carriage Lifting Shop (Building 23) and the Painting Shop (Building 22). These drawings include plans, sections, elevations and foundation details (see *Fig 22.1*).

16.2.3 Most of the post-war site plans seen in the current project focus on the historic centre of the Old Oak Common complex around the engine shed and they only show the northern edge of the Pullman Shed. One exception is a plan of 1959 which is principally to detail the conversion of the adjacent Structure 22 but also shows Structure and labels it as the Carriage Lifting Shop (2515/410/0690). Another plan from 1966 also shows the footprint of Building 23 although this time it's function is not labelled (2515/410/2172. See Gen Fig 13).

16.3 **Description**

16.3.1 **External Description**

16.3.2 Structure 23 was a single-storey building, which ran parallel to the adjoining Structure 22, and it had a rectangular plan (125 m x 21.5 m) and a gabled roof. The roof was covered in a corrugated cladding and incorporated two rows of slightly raised roof lights to each slope. At the south-western corner of the building were a group of small, related structures (principally substations) which are numbered as Structure 36 and described in a separate section of this report.

16.3.3 The general construction of the building was very similar to that of the contemporary Structure 22 (although it was taller), comprising a steel structural frame with stanchions encased in concrete and a pink/beige brickwork to the infill panels.

16.3.4 The **south elevation** (Plates 23.1) formed the main face of the building, facing out onto open ground, and comprised 34 similar bays articulated by the structural frame (steel encased in concrete). Similarly to the main side walls of Structure 22 the main bays of the south elevation had a narrow 'plinth' panel at the base, a larger panel



above this with a window and a parapet at the top which was above the structural frame and which hid the building's eaves. However, the greater height of Structure 22 meant that there were two further blank brick panels in each bay between the windows and the parapet.

16.3.5 Bays 1 to 17 in the southern elevation all contained primary 36-light windows. In the middle of the elevation's length, against Bays 18 and 19, there was a narrow primary WC projection, with a flat roof covered in asphalt. This is shown on the original construction drawings. As a consequence, Bay 18 has a 24 light primary window, and Bay 19 a 12-light window that appeared to have been inserted. In these two bays the window sill was raised, and looked to be part of the structural frame. Bays 20 to 28 and 30 and 31 had primary 36 light windows. Bay 29 contained a roller shutter door and Bays 32 to 34 were plain brick panels. All the windows in the south wall had 'arrow' glazing bars facing inwards, but in this case, unlike Structure 22, the windows do open the right way.

16.3.6 The **western elevation**, (*Plates 23.3-23.4*) facing the bank at this end of the site, displayed four large windows, all five rows of six lights each with a four-light pivoting window at the top, and a high-level bullseye. Similarly to the adjacent end of Building 22 the upper part of the gable was divided into three shallow recessed panels. The windows had flat-faced glazing bars to the inside.

16.3.7 The **east elevation** (*Plates 23.8-23.9*) again had a tri-partite design with three large openings at ground floor for the roads (numbered Roads 1-3) and above this three slightly recessed panels in the gable. There was a 12-light bulls-eye window towards the top of the central panel. Each of the ground floor openings had secondary roller shutter doors which replaced the primary double doors

16.3.8 Internal Description

16.3.9 The interior of Building 23 was an open plan hall, well illuminated by the long rows of roof lights and the structural frame at least partially exposed. This building had a more open and airy character than Structure 22, partly due to its greater height but also due to the fact that none of the trusses were closed with panelling (*Plate 23.10*).

16.3.10 The **roof** comprised 33 light-weight metal trusses essentially the same as those in Structure 22 and typical for the mid 20th century (*Plate 23.18*). Each truss was constructed from L-section steel members joined by rivetted steel connecting plates. Each truss had seven vertical struts and six raking struts, together with principal rafters and tie-beam. The vertical struts were formed from single L-section steels while the other main members were formed from coupled pairs of L-section steels. There were three timber purlins to each slope supporting the raised roof lights as well as L-section steel purlins onto which the cladding was fixed. The south ends of the trusses were supported by a steel plate, high in the wall and supported by tall stanchions every third truss, while the north end of the main trusses were supported by the large steel girder in the wall between Structure 22 and 23. This girder was again supported by stanchions every third truss.

16.3.11 Although all the trusses looked identical, this was not the case. Every third truss, the ones that coincided with the stanchions, had a deeper footing in the concrete for the



truss end. The post beneath this footing, that carried the load from the roof onto the main high-level girder between Structures 22 and 23, was also wider, meaning that it projected out further from the brick nogging than its neighbours.

- 16.3.12 The **north wall** of Structure 23 was formed by the immense high-level horizontal girder between Buildings 22 and 23, supported on 11 stanchions and described further in the section of Building 22. The five regular openings in the corrugated tin cladding between Structures 22 and 23 were primary; the steelwork seems to fit but the wider opening at the east end is secondary.
- 16.3.13 There had originally been five roads, although only three remained in use. Parts of the other two remained visible as tracks, but the majority had clearly been covered.
- 16.3.14 Perhaps the most impressive features of the building were a pair of large **travelling cranes** (*Plates 23.22-23.26 and 23.31-23.32*) constructed by Wharton of 'Stockport England', rated to 20 tons, which spanned the width of the building. These were structurally separate from the building and were supported on high-level, heavy duty rails on eleven stanchions by Dorman Long & Co. The stanchions aligned with the stanchions that supported the high-level girder between Structures 22 and 23, the two being fixed together by five spacer brackets. Lateral restraint was provided by cross-braced rods springing from a circular eye and bolted to the stanchions in the last bays but one at each end. The cranes allowed carriages to be lifted by means of two 'V'-shaped drop arms that could travel laterally across the width of the crane. Wharton Crane and Hoist Co Ltd was founded in 1906 and by 1961 were manufacturers of electric and hand overhead travelling cranes, electric and hand chain blocks and rope hoists, industrial lifting platforms and automobile lifts. They were in financial trouble by 1978.
- 16.3.15 The **floor to Structure 23** was largely of concrete, but at the west end of the building an interesting arrangement of wooden wedge-shaped blocks had been used instead. These had been tightly fitted together to form an interlocking pattern. This was interrupted by pads for posts and plates. Each block was c.35 cm long and the outer edge was 19 cm wide.
- 16.3.16 At one time perhaps all of the western end of the structure had been floored with these blocks, but over time patches of concrete had been inserted. An interesting plan from Oct 1938 (WHSC 2515-406-0900) shows the arrangement of machinery at this end of the building – two wheel lifts and an electric lift for carriage wheels. These wedge shaped blocks are believed to have been of teak and they used to be components of Mansell wooden wheels dismantled when steel became the favoured material for wheels. Mansell wheels were solid and included a central section of wooden blocks in place of spokes. Their reuse in features such as floors is relatively common and one example is at Liverpool's Edge Hill.
- 16.3.17 As mentioned in the external description there was a WC block towards the centre of the north wall, projecting outside the main footprint of the building, and this had impressively tall primary urinals (*Plate 23.30*). The WC was accessed by primary doors, the same as those in Structure 22, and it had windows in the western and eastern elevations.



Structure 23 Plates

- Plate 23.1: General view of south elevation
- Plate 23.2: Western end of south elevation
- Plate 23.3: West elevation
- Plate 23.4: Gable at west end of building
- Plate 23.5: Western end of south elevation
- Plate 23.6: Eastern end of south elevation
- Plate 23.7: General view of south elevation
- Plate 23.8: East end of Building 23
- Plate 23.9: East elevation of Building 23
- Plate 23.10: General view of interior looking east
- Plate 23.11: North wall, shared with Building 22
- Plate 23.12: General view in Building 23 looking west
- Plate 23.13: East end of Building 23
- Plate 23.14: Detail of upper panels in north wall
- Plate 23.15: General view of south wall
- Plate 23.16: Internal view looking east
- Plate 23.17: Typical view of south wall
- Plate 23.18: Roof detail
- Plate 23.19: Areas of wood-block floor at west end
- Plate 23.20: Areas of wood-block floor at west end
- Plate 23.21: Detail of wood-block floor
- Plate 23.22: Crane stanchion at west end of north wall
- Plate 23.23: Crane at west end of Building 23
- Plate 23.24: Detail of crane at west end
- Plate 23.25: Underside of crane at east end
- Plate 23.26: Underside of crane at west end
- Plate 23.27: Road looking west
- Plate 23.28: Typical rivetted stanchion against south wall
- Plate 23.29: Door to WCs against south wall
- Plate 23.30: urinals in WC lean-to against south wall of Building 23
- Plate 23.31: Crane at east end of Building 23
- Plate 23.32: General view of west end of Building 23



Plate 1



Plate 2



Plate 3



Plate 4



Plate 5



Plate 6



Plate 7



Plate 8



Plate 9



Plate 10



Plate 11



Plate 12



Plate 13



Plate 14



Plate 15



Plate 16



Plate 17



Plate 18



Plate 19



Plate 20



Plate 21



Plate 22



Plate 23



Plate 24



Plate 25



Plate 26



Plate 27



Plate 28



Plate 29



Plate 30



Plate 31



Plate 32



17. STRUCTURE 24: SUMP/OIL INTERCEPTOR

17.1.1 Introduction and summary

17.1.2 The sump oil interceptor was situated close to the centre of the site, immediately to the east of the Stores (Structure 16b) and adjacent to a bunded waste oil tank (Structure 52).

17.1.3 The DDBA assessed that the Sump/Oil Interceptor could survive from Churchward's original Edwardian depot (albeit with significant alterations) and that the surviving original railings were therefore of regional significance. It has been recorded in the current works at EH Level 2.

17.1.4 Description

17.1.5 Structure 24 comprised a sunken, shuttered concrete-lined sump-pit (c.3.5 m x 7 m in plan) above which was set a metal grille and pump plant set on an RSJ across the pit. The RSJ supported a large oblong steel tank or container sat centrally within the footprint of the grille, and twin sets of pumps to which flexible hoses were attached mounted to the south of the tank; another was located to the east. A grey control box was mounted to the western side of the tank (*Plates 24.3-23.4*).

17.1.6 A square hinged, steel inspection cover was contained within the grill at the western end of the structure, against which were three concrete blocks with the same profile as the surrounding edging. A small external plinth against these blocks looked like a step, but was too narrow to be so.

17.1.7 The grille, RSJ and pump were all secondary alterations but the sump-pit was surrounded by a set of attractive older steel/iron railings. There were two panels of railings on the northern and southern sides with one on the east. The panels were articulated at each end with larger square-section posts which were bolted to the concrete edging of the sump. The western side was open, but there was evidence that there were once gates here. The posts were modestly decorated cast items, with ball finials and do not accord with either the date of the apparatus sat within the fencing, nor the apparent age of the concrete edge. It is possible that they dated from an earlier version or iteration of this structure, or had been re-used from elsewhere.

Structure 24 Plates

Plate 24.1: General view of railing panel looking north

Plate 24.2: Detail of railing fixing

Plate 24.3: General view looking east

Plate 24.4: General view looking north.



Plate 1



Plate 2



Plate 3



Plate 4



18. **STRUCTURE 36: SUB-STATION B3 (BRICK-BUILT ELEMENT,)**

18.1.1 **Introduction and summary**

18.1.2 At the western end of the south side of Building 23 (Carriage Lifting Shop) there was a small group of structures which collectively comprised Structure 36. The principal structure was a brick building adjoining Building 23 at the very western end of the south elevation and this was probably contemporary with the late 1930s construction of the lifting shop.

18.1.3 The DDBA assessed this building as being of local significance. It has been recorded in the current works at EH Level 2.

18.1.4 The wider group of buildings that collectively comprised Structure 36 included a much later detached building formed from pre-fabricated metal but this is described below. The group also included two external transformers with fencing around them.

18.1.5 **Description**

18.1.6 The structure at the very western end of the south elevation of Structure 36 is a single storey brick building with a flat roof. The main primary building is constructed from a light pink/salmon colour, the same as the main carriage lifting shed and it has a rectangular plan (5.5 x 3.5 m). There was also a simple low shoulder six bricks above ground level.

18.1.7 At the eastern end of the southern wall (*Plate 36.4*) a small secondary extension had been added in a beige brick which was similar to the brick used in the reconstruction of the east end of Structure 22 (in c.1940). The west elevation of Building 36 had been largely rebuilt with the same beige coloured brick used in the extension (but without the low shoulder) and it may be that it was dismantled to allow the removal/replacement of a large transformer (or other plant) inside (*Plate 36.3*). To the north end of the west elevation was a simple set of double doors.

18.1.8 There was a similar simple set of double doors in the east wall of the building but the southern wall of both the primary Building 36 and the secondary extension were plain (*Plate 36.2*).

Structure 36 Plates

Plate 36.1: General view from south

Plate 36.2: View looking north-west

Plate 36.3: View looking north-east

Plate 36.4: View looking north



Plate 1



Plate 2



Plate 3



Plate 4



19. **STRUCTURE 3: CARRIAGE WASHING PLANT**

19.1.1 Introduction and summary

19.1.2 The Carriage Washing Plant was located towards the south-eastern corner of the site and formed a functional group with Structures 7 (Carriage Washer Treatment Plant) and 8 (Water Tower). These three structures were all probably constructed in the last quarter of the 20th century.

19.1.3 The DDBA assessed this building as being of negligible significance. It was recorded in the current works at EH Level 1.

19.1.4 Description

19.1.5 The Carriage Washing Plant was a long simple structure comprising a series of static and rotating brushes set on two upstanding fixed banks either side of a section of track. This allowed trains to pass between the brushes whilst being sprayed with water to clean the carriages. This machinery was relatively modern, dating to the last decade of the 20th century or later. The upstanding banks that housed the brushes had steel frames and were clad in metal sheeting.

Structure 3 Plates

Plate 3.1: View of washing plant looking south-east

Plate 3.2: View looking west

Plate 3.3: View looking west

Plate 3.4: View looking east



Plate 1



Plate 2



Plate 3



Plate 4



20. STRUCTURE 4: UNDERFRAME CLEANING SHED

20.1.1 Introduction and summary

20.1.2 The Underframe Cleaning Shed was a large prominent building located to the eastern edge of the main group of buildings and facing the front of the Factory complex (Structure 15). It was set alongside the large group of roads which approached the doors of the Factory. The building was probably constructed in c.1965 during the period when the depot was converted to a diesel MPD. The original building appears to have been re-clad, possibly during the 1980s.

20.1.3 The DDBA assessed this building as being of local significance. It was recorded in the current works at EH Level 1.

20.1.4 Description

20.1.5 This was a large rectangular plan building which straddled a centrally-placed single track. The lower parts of the walls were of brick, in stretcher bond, with the upper part and the roof structure formed from a steel frame covered with corrugated metal panels. The roof had a shallow double-pitch profile and was supported on steel joists. It was clad in corrugated steel panels interspersed with corrugated roofing light panels. Pedestrian access was via two doorways in the western end, whilst the eastern gable contained one pedestrian door and a larger, roller-shuttered door opening to allow vehicular access. A further door was located at the western end of the southern elevation. Large steel roller shutter doors in each end gable allowed trains to enter and exit. Lamps on the corners of the gable ends were accompanied by modern signs that read 'Warning No Unauthorised Entry when light is displayed'.

20.1.6 Ventilation was provided by high-level circular fans above the gable-end locomotive doors. A steel chimney emerged halfway up the northern elevation, and there was also a detached grey steel cabinet against the north elevation with its own, stainless steel, chimney and a steel duct entering the building. There was also another piece of external apparatus attached against the southern elevation, in the same relative position. A narrow, flat-roofed, brick-built extension was attached to the eastern end of the southern elevation. The roof was covered with roofing felt, through which a stainless steel flue protruded. Inside this structure, which was open to the remainder of Structure 4, were various items of machinery and pipework (see Plate XX).

20.1.7 The interior of the shed had an inspection pit running the length of the building between the tracks. A steel gantry on either side of the track provided a walkway at train roof height. These were fitted with pipework that were connected to a 'Scotkleen' pressure washer so that hoses could be attached at various points along the gantry. The pressure washer was exhausted via the chimney attached to the northern elevation. Wide metal grills in the floor on either side of the track allowed water to flow to drains beneath. The internal walls were of concrete block, painted white. The steel superstructure was exposed. A simple steel-framed work bench, covered in steel, placed against the internal southern elevation. carried a vice.

Structure 4 Plates

Plate 4.1: General view of exterior looking south-east

Plate 4.2: East end of the building



Plate 4.3: East end of the building

Plate 4.4: General view looking west



Plate 1



Plate 2



Plate 3



Plate 4



21. STRUCTURE 5: STEAM-RAISING PLANT

21.1.1 *Introduction and summary*

21.1.2 This structure was located towards the north-east of the main group of buildings at Old Oak Common and it was immediately to the west of the Underframe Cleaning Shed (Structure 5) for which it generated steam. It was contemporary with Structure 5 and was thus probably constructed in c.1965.

21.1.3 The DDBA assessed this building as being of local significance. It was recorded in the current works at EH Level 1.

21.1.4 *Description*

21.1.5 This single storey, rectangular plan building was faced with red brick laid in a stretcher bond over an inner construction of concrete blocks. The building had a flat roof with bitumen roofing felt overlapping the timber fascia boards that extended across the top of all four elevations (*Plate 5.1-5.2*). There were metal-framed, opaque glass windows set on concrete sills in both north and south elevations (the lintels were also of concrete). The east and west elevations contained pedestrian doors, the eastern an original opening with a pair of timber louvre doors. The western door was of recent steel roller-shutter type. The original entrance was in the south elevation where a pair of narrow, angled doors shared access to a triangular porch area, and gave access to three rooms, the largest to the west, with a small area only accessible from outside via the louvre doors at the east end. The modification of the western elevation with a new entrance and cement render implies a recent change of use.

21.1.6 A set of metal scales (rated to 220lbs) on a timber trolley with a metal handrail were situated inside the building (*Plate 5.3*). The maker's mark on the backplate read: 'H Pooley & Son LTD contractors BR (W) 11347'. The face of the scales indicated that they had been built in Birmingham. The serial number was S-584164. The firm was founded during the 18th century in Liverpool, where it remained until it moved to Birmingham in the 1890s. In 1913 the firm became part of the Avery organisation, although it continued to manufacture goods under its own name ('English Weights and Measures', online at: <http://home.clara.net/brianp/nameskp.html>). The firm was responsible for supplying and maintaining the weights and scales of many railway companies and continued to do so until after nationalisation, as this example attests.

Structure 5 Plates

Plate 5.1: General view of east side of building

Plate 5.2: West side of building

Plate 5.3: Scales inside building

Plate 5.4: East end of building



Plate 1



Plate 2



Plate 3



Plate 4



22. STRUCTURE 7: CARRIAGE WASHER TREATMENT PLANT

22.1.1 Introduction and summary

22.1.2 This was situated in the south-eastern part of the site, to the north of the roads leading to the Pullman Shed (Structure 22). It was a modern structure and was probably constructed in the last quarter of the 20th century. This building had a functional relationship to two other modern structures in this part of the complex, each of which were associated with the cleaning of carriages. These other two were Structure 3 (Carriage Washing Plant) and Structure 8 (Water Tower).

22.1.3 It was recorded in the current works at EH Level 1.

22.1.4 Description

22.1.5 **Exterior:** Structure 7 was essentially, a plain, rectangular box constructed from full-height, pre-fabricated structural glass fibre panels to walls and roof, with a plastic coating; There were 8 panels to each side and 5 panels to either end. The panels had a subtle decorative face showing interlocking hexagons, all fixed together internally with nuts and bolts. There is a small grille in the east elevation. The building had a very shallow double-pitched roof, again formed from glass fibre panels bolted together, and it was placed on a concrete slab. There were no windows and the only entrance was in the west elevation, comprising a pair of doors. A cylindrical steel tank with a conical roof was situated immediately east of Structure 7. This appeared to be contemporary with the main Building 7 and the tanks inside it.

22.1.6 The most interesting feature of this structure was an external emergency shower and eyewash station (*see Plate 7.4*) which drained into a central drain set in the external concrete apron in front of the western gable.

22.1.7 **Interior:** inside the building there were several sunken trenches within the floor for pipes, covered with grilles. There was also a large plastic tank at the west end with train cleaning detergent inside and a second tank containing soft water. The larger tank had a notice showing the contents as 'Mild Alkali Detergent Train/Tube Exterior Cleaner' and it was supplied by Bingham Traincare. The remaining space inside the building was taken up with many pipes, valves, switchgear cabinets *etc.*

Structure 7 Plates

Plate 7.1: South elevation of Building 7

Plate 7.2: East end of Building 7

Plate 7.3: North elevation of Building 7

Plate 7.4: West end of Building 7



Plate 1



Plate 2



Plate 3



Plate 4



23. STRUCTURE 8: WATER TOWER

23.1.1 Location and outline history

23.1.2 Modern water tower situated towards the southern end of the main group of structures at the site. From the nature of the steelwork the structure was probably constructed in the last quarter of the 20th century and certainly later than the other water tower (Structure 13). As referred to above this water tower was related to two other modern structures in this area which were used for cleaning carriages. The other two were structure 3 (Carriage Washing Plant) and Structure 7 (Carriage Washer Treatment Plan).

23.1.3 The DDBA assessed this building as being of negligible significance. It was recorded in the current works at EH Level 1.

23.1.4 Description

23.1.5 The walls of the tanks were formed from pressed square panels jointed together – the ends of the tank were three panels tall and four panels wide and the sides were five panels in length. Each side bay joint was supported on a RSJ (so six in total), in turn supported by two perpendicular RSJs. These RSJs were supported by a tower constructed from RSJs, bolted together into a modular frame of five lifts, each with diagonal bracing.

23.1.6 A steel ladder extended up the western side. This had two stages, the second of which extended to the full length of the underside of the tank. From here, a further ladder gave access to the lip of the tank. A simple post and bar fence protected the four sides of the tank, swelling out to provide space for personnel to stand on top of the ladder.

23.1.7 An insulation-clad pipe emerged from an underground chamber, angled twice, and then passed inside the tower towards the underside of the tank, being separated from it by a heavy-duty assembly that was attached to the tank.

Structure 8 Plates

Plate 8.1: view of water tower looking north-east

Plate 8.2: view of water tower looking south-west



Plate 1



Plate 2



24. **STRUCTURE 9-10: TEMPORARY METAL STORE**

24.1.1 **Location and outline history**

24.1.2 This building was located on the east side of the main central cluster of buildings at the site, just to the east of the water tower (Structure 13) and Water Softening Plant (Structure 12). It was a modern structure and was probably constructed in the last quarter of the 20th century. It was immediately adjacent to a similar sized building which was No.10 (Safety Store) in the official site numbering although this had been demolished prior to any recording works. On some plans there is inconsistency over which is No.9 and which is No.10.

24.1.3 The DDBA assessed this building as being of negligible significance. It was recorded in the current works at EH Level 1.

24.1.4 **Description**

24.1.5 The Temporary Metal Store was a very simple, single-storey, steel-framed shed with a rectangular plan and clad in corrugated metal sheeting. The only opening in the wall cladding was on the north side where there was a wide triple doorway with sliding doors. The steel walls were constructed from simple RSJ posts and three rails to each panel with occasional diagonal bracing. The corrugated cladding was bracketed to the steelwork.

24.1.6 The roof, which was also clad in corrugated sheeting, had a slight slope from north to south and was formed from coupled softwood rafters. The roof incorporated simple sky-lights although the interior was also illuminated by fluorescent lights. The single-cell building had a concrete floor and there was no clear evidence of the former use of the building. Graffiti inscribed in the concrete floor whilst wet read 'Pat C 1990'.

Structure 9 Plates

Plate 9.1: Western part of north wall

Plate 9.2: Eastern part of north wall

Plate 9.3: Interior looking west

Plate 9.4: West wall



Plate 1



Plate 2



Plate 3



Plate 4



25. STRUCTURE 12: WATER SOFTENING PLANT

25.1.1 Location and outline history

25.1.2 The water softening plant was situated directly east of the water tower (Structure 13), in the centre of the site and would have been fed from the water tank via underwater pipes. Its position, over the former coal stage sidings, confirms that it post-dated the conversion of the depot into diesel motive power in the mid 1960s and probably dated to that episode.

25.1.3 The DDBA assessed this building as being of local significance. It was recorded in the current works at EH Level 1.

25.1.4 Description

25.1.5 **Exterior:** The structure was a simple brick building with a rectangular plan, but with an usual stepped profile, so that it lifted in stages that were unequal in depth and height (*Plate 12.2*). The east wall was blank, the west wall had one window centrally placed within the lowest lift, and the south wall, the full height elevation, carried a central recess with windows set in it (*Plate 12.4, 12.5*). The north elevations (because, of course, there were three) were in stretcher bond in, like the rest of the building, a light brown brick. The lowest stage had a central, full height opening with a steel roller shutter, and a window to the right. Each stage had a flat roof with softwood fascias and skylights with opening ventilators. The windows were metal-framed; there were concrete lintels throughout. The east wall had been used to sign demarcated storage areas for consumables, for example antifreeze, each being noted with its individual part number. A simple external cage of tubular steel and wire mesh was situated against the south-western corner – modern sign stating ‘Danger No Smoking Full Bottles’ suggests this had been used to store gas.

25.1.6 **Interior:** The roller shutter doors gave access to the full length of the ground floor. The internal walls of the lowest bay, situated at the northern end of the building, were of brick painted white (*Plate 12.7*). The ceiling was formed from softwood joists with plasterboard cladding while the floor was of concrete. Two small areas to either side of the main entrance had been formed by an internal east-west brick wall. The western area was open, whilst the eastern area was closed by a short north-south wall – a modern panel door provided access into what had presumably been an office (the room had been lit by the two ground-floor windows of the building, both made secure by external steel bars, but these had been boarded internally to close them).

25.1.7 The side walls of the central bay were formed of concrete block internally. Stepped brick piers acted to separate the central and southern areas – these supported a high level RSJ which carried the northern wall of the southern bay. A frame of RSJs supported a metal grille floor at first-floor level in the eastern half of the southern bay – the western half had a plasterboard ceiling carried on softwood joists – this did not form a floor at first-floor level. A guard rail protected personnel working at first-floor height on this gridded floor – a central gap gave access into the western half of the southern bay. Access onto the metal-gridded area was gained via an external foot set into the northern elevation of the southern bay – there was no internal access.



25.1.8 A large water tank was situated in the uppermost part of the southern bay, above the metal grille floor (*Plate 12.6*). This was supported on two north-south RSJs. The tank was formed from the same modular steel panels as the water tower (Structure 13), two deep by one wide. Pipes and a valve exited the tank and were carried down the internal south-eastern corner of the structure – this system had been removed below the first floor before they were recorded. All electrical supply was carried by conduits attached to the walls – control units were attached to the south-east corner of the southern bay. The central bay was heated by an electric radiator.

Structure 12 Plates

- Plate 12.1: North elevation of Building 12
- Plate 12.2: General view looking south-west
- Plate 12.3: East wall of Building 12
- Plate 12.4: South elevation of Building 12
- Plate 12.5: Detail of south elevation
- Plate 12.6: Internal view in tallest section
- Plate 12.7: Internal view looking north
- Plate 12.8: General internal view



Plate 1



Plate 2



Plate 3



Plate 4



Plate 5



Plate 6

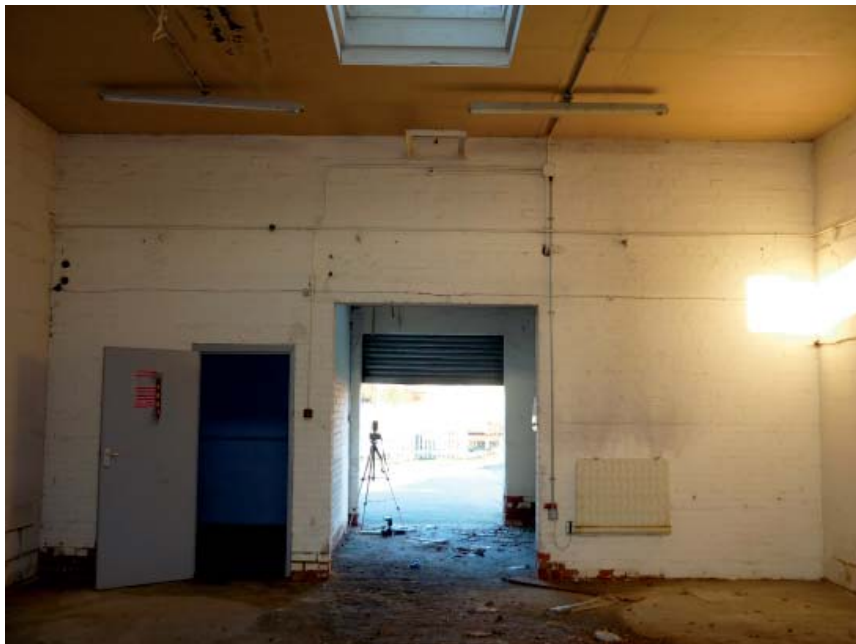

Plate 7



Plate 8



26. **STRUCTURE 13: WATER TOWER (SOFT WATER)**

26.1.1 **Location and outline history:**

26.1.2 This tower was situated towards the centre of the site, to the east of the Office/Stores (Structure 16b) and over the position of the former coal stage sidings. It tower either post-dated the conversion of the yard to diesel power in the mid-1960s or formed part of the mid-1960s conversion works themselves. The water tower fed the water softening plant (Structure 12) just to the west via underground pipes.

26.1.3 The DDBA assessed this building as being of local significance. It was recorded in the current works at EH Level 1.

26.1.4 **Description**

26.1.5 A large tank was supported at each corner by four heavy-duty stanchions set on concrete plinths (*Plate 13.1*). The stanchions were formed from two C-section RSJs braced by various plates and connectors rivetted to the RSJs. The stanchions, which were stamped 'Earl of Dudley Steel' supported two large horizontal RSJs which bore eight shorter transverse RSJ rails which carried the tank. The stanchions were joined mid-way to their height at each end, above which crossed tie bars further bracing the stanchions (*Plate 13.2*). The tank itself on top of the support structure was formed of modular square plates, impressed to add strength, and bolted together. The base of the tank was formed from four rows of seven plates, the long sides being of two rows of seven, and the sides of two rows of four. The top of the tank was open to the skies.

26.1.6 A steel ladder attached to the east elevation at a raked angle gave access to a platform projecting from the upper lip of the tank and supported by two raking struts. The platform did not carry edge protection, but the ladder did, in the form of simple handrails and hoops. Four vertical pipes emerged from the base of the tank, three of them protected with cork insulation. Valves stopped the easternmost set at chest height, with the single pipe to the west curving twice at ground level before entering the ground, and branching immediately beneath the base of the tank.

Structure 13 Plates

Plate 13.1: General view of water tower looking south-west

Plate 13.2: Detail of water tower structure



Plate 1



Plate 2



27. STRUCTURE 17B: NEW AMENITY BUILDING

27.1.1 Location and outline history

27.1.2 The New Amenity Building (Structure 17B) formed a mid 20th-century extension to the east side of Building 17a, an original structure from the Edwardian complex which was converted to a canteen during the Second World War (detailed in separate section above). The extension (17b) is known to have been constructed by July 1963 as it is shown on a photograph of this date for sale on Ebay in September 2013 (not reproduced here). From the architecture of the building it seems likely that it was constructed shortly before this date and a site plan from 1958 confirms that it had not yet been built. It is shown on a site plan of 1966 and together with Structure 17a it is labelled Amenities Offices.

27.1.3 The building had a modernist (Brutalist) design that contrasted sharply with the original brick Edwardian building to which it formed an extension and it was typical of many railway structures from the post-war period. The building reflects something of the architectural confidence of the post-war period and the British Rail architects appear to have felt no need to complement the existing structure or to blend the design of the new structure into that of the building's of the original complex. It was an attractive building, of modest scale, that used a variety of materials and showed a clear juxtaposition with Structure 17a.

27.1.4 The DDBA assessed this building as being of local significance. It was recorded in the current works at EH Level 1.

27.1.5 Description

27.1.6 **Exterior:** The New Amenity Building was a two-storey structure with a flat roof and an enclosed staircase tower at its eastern end (*Plate 17b.3*). The building was constructed from a concrete-rendered steel frame with the frame expressed externally and with infilling brown brickwork (bricks 6.5 cm x 22 cm). The ground floor had narrow windows at head height along its two long elevations (north and south) and above these windows the first floor structure was cantilevered by c.1.4m, supported by concrete beams (*Plates 17b.1, 17b.2*). Each of these long first floor elevations was glazed along its length with primary metal framed windows and low panels enclosed within the structural frame. The brown brickwork was laid to stretcher bond and there were expansion joints in the ground floor brick panels.

27.1.7 The frame was expressed on the east gable of the main block, between which were further brick panels. The eastern tower projection (containing the stairs and plant room) was of similar construction with concrete panels and brick infill but it had a strong vertical emphasis to juxtapose the horizontal emphasis of the main building. This gave the overall building the external appearance of two perpendicular blocks interlocking. At the north-east corner there was a covered external space.

27.1.8 Interior:

27.1.9 The internal layout on both floors consisted of large open plan rooms with rows of Y-shaped concrete pillars (32 cm²). These Y-shaped columns continue through the old adjacent range (17a) which was clearly reconstructed internally in the c.1960s works.



- 27.1.10 The ground floor was essentially a single open space with a row of concrete columns along the central line, and further lines along the northern and southern sides (3 rows in total) close to the edge of the building to allow the non-structural curtain walls (*Plate 17b.5*). Immediately to the east of the staircase was the women's WC, and then a much larger men's WC. The WC's ranged along the whole of the south wall. Large pairs of posts of reinforced concrete (or steel frame encased in concrete), similar to the first floor with a sloped head, beams project beneath floor level.
- 27.1.11 The first floor was also essentially a single open space, with partitioned offices along the southern aisle and a further partitioned-off room in the north-east corner. The floor was of concrete, painted red (*Plate 17b.6-17b.9*). There were two east-to-west rows of concrete posts along the northern and southern sides, offset inwards by 2.2m from the outer curtain wall. The posts tapered towards their bases and supported shallow load-spreading heads which, in turn, carried the north-to-south beams. This configuration was repeated six times along the length of the structure, but at the west end there was another pair to form part of the west wall of the building. Another anomaly was a third, central, post in the easternmost frame. There was a pair of rooflights towards the centre of each bay. The four offices along the southern aisle were formed from stud walls divided into three rows, with large areas of wire-glass window filling the upper two rows; there was a fifth office inboard of the eastern office. There were two sinks and a bank of worktops in the north-west corner providing, perhaps, an office kitchen but not a major catering area. One interesting feature was an incinerator set into a recess in the wall of the office in the north-east corner, but facing into the main room (*Plate 17b.12*). This had been constructed by Heenan and Froude of Worcester, and was labelled a Horsfall No 5 Destructor. The engineering company of Heenan and Froude was founded in Newton Heath, Manchester in 1881 and started to fragment into component parts in the late 1960s. There was a lid in the top, and its occurrence in this building starts to suggest that it was designed as a large open-plan office, with managers in the partitioned office spaces. It had fallen from use before the building itself because it had been panelled in and forgotten about.
- 27.1.12 The stairs at the east end wrapped round a vertical duct that contained pipes and climbed to a second-floor plant room.

Structure 17b Plates

- Plate 17b.1: South elevation of Building 17b
- Plate 17b.2: South elevation of Building 17b
- Plate 17b.3: Eastern end of south side of Building 17b
- Plate 17b.4: East elevation of Building 17b
- Plate 17b.5: Inside main ground floor room
- Plate 17b.6: First floor looking north
- Plate 17b.7: First floor looking north-east
- Plate 17b.8: First floor looking north
- Plate 17b.9: First floor looking north-west
- Plate 17b.10: First floor room
- Plate 17b.11: Sign within building (first floor)
- Plate 17b.12: Stove exposed at east end of first floor



Plate 1



Plate 2



Plate 3



Plate 4



Plate 5



Plate 6



Plate 7



Plate 8



Plate 9



Plate 10



Plate 11



Plate 12



28. STRUCTURES 11 AND 18: OFFICES

28.1.1 Location and outline history

28.1.2 These two portacabins were located close to the centre of the site, just to the west of the stores (Structure 16), and they were probably constructed in the period c.1990-2000.

28.1.3 The DDBA assessed this building as being of negligible significance. It was recorded in the current works at EH Level 1.

28.1.4 Description

28.1.5 These formed an 'L'-shaped group of semi-permanent, suspended, offices formed from portable cabins, within the footprint of Churchward's original Engine Shed and directly north of the diesel maintenance refuelling shed (Structure 19). A free-standing sign on the western elevation identified the buildings, rather grandly, as Churchward House, property of EWS Railways Ltd (although transfers on the north-facing fascia identified the smaller block as being called 'Reston House'). The complex was used as offices and classrooms for engineers and technical and clerical staff. The buildings, single-storey with a flat roof and panel clad had been provided with concrete steps to entrances and exits. Aluminium windows, barred, and a blue fascia at roof level. In the north-west corner there was a raised bed with bull-nose bricks and a raised path going round it.

Structure 11 Plates

Plate 11.1: south side of building

Plate 11.2: General view looking south-east



Plate 1



Plate 2



29. STRUCTURE 19: DIESEL REFUELLING MAINTENANCE SHED

29.1.1 Introduction and summary

29.1.2 The Diesel Refuelling Maintenance Shed was a large building located to the south-west of the main Stores (Structure 16). It formed an essential part of the British Railways plan to convert the depot from steam to diesel power and it opened in March 1965 on land which had previously housed the south-easternmost of the four 1906 turntables inside the Engine Shed. The DDBA assessed this building as being of local significance. It was recorded in the current works at EH Level 1.

29.1.3 Description

29.1.4 The single-storey building was rectangular, aligned east-west, with a double pitched roof and gables at the east and west ends (*Plates 19.1, 19.2*). It had three railway tracks running through the building, with steel roller shutters covering the openings at either end. The building was constructed from twelve pairs of vertical steel I-beams supporting the steel roof trusses, with the bays between infilled with concrete block on the inside and a skin of brown-coloured brick in stretcher bond on the exterior. Narrow, clerestory wired glass panels ran the length of the top of both north and south walls, ie above the RSJ wall plates. The external western part of the north wall had been divided into eight bays within which hand-painted signs stated which materials were to be found (eg EP 90, axle oil, detergent, machine cleaner or Stratford 7.30032 Chassie Cleaner [sic]).

29.1.5 The roof was clad in corrugated metal panels with eight large, projecting vents on each slope and two much smaller vents and walkway just above the roof. A very simple open-faced metal-framed shelter with a corrugated tin roof had been constructed against the southern elevation, to the east of which were steel signs with peeling vinyl graphics reading 'Scrap Steel Only' and 'Brake Blocks Only'. Exterior lights were attached to this elevation at intervals and were connected by steel conduit. Each gable contained large roller-shutter doors separated by brick piers, through which the tracks passed, and above which was a large window of wired glass which occupied the apex of the gable. The brickwork at each end of the gable was in Flemish bond. Large steel signs above each track have a number to the doors. The doors had at some time been painted in black and yellow stripes, but parts or all of the shutters had clearly been replaced since the painting was not universal. Wooden signs reading 'Stop Before Entering Shed' bookmarked the eastern gable, but these were absent from the western gable where instead there were a pair of pedestrian doors in timber frames. At the south-eastern corner of Structure 19 was a simple covered walkway between the door in this corner and Building 17a.

29.1.6 Several buildings had been attached to the northern elevation of the shed. Attached to the north-eastern corner was a concrete block structure with two high-level windows (on the northern and eastern elevations) and a door with a concrete lintel in the northern elevation. This had been used as a tool store and had clearly been constructed within the covered walkway that had provided covered access between Structure 19 and Structures 16a and 16b. Immediately to the west of the tool store was a long, single-storey structure of light brown brick in a stretcher bond – this was contemporary with the main shed. This had a flat, asphalt-covered roof, timber fascias and three windows set into the northern elevation – one of shallower depth but each



with metal frames and concrete sills and lintels. A full-height sliding door of timber was also set into this elevation. To the east of this door was a section of irregular, rebuilt brickwork – full height and extending underneath the adjacent window. The west elevation of the structure contained an inserted door and window. Beside the door was a spray-painted graffito reading 'QPR 1 CFC 0'. Re-used track had been used for three posts that were offset from the north elevation. Internally, the brick walls were painted and there were ceiling panels. Large openings with RSJ lintels between this building and the shed would have made it an integral part of the main shed activities – one of these was covered with a roller shutter door. There was a small room marked 'Switch Room' at the eastern end of the structure, with several transformers *etc* inside.

- 29.1.7 Attached to the NW corner of the long single-storey structure was a taller, rectangular almost double-height building (4.5m tall). This was of brown brick in stretcher bond, and was keyed into the building to which it was attached. A door with a concrete lintel was let into the northern half of the eastern elevation, and the north wall contained two windows with metal-framed casements and concrete sills and lintels. The windows were in the centre of the wall, suggesting the interior was of a single, double-height space. Flat roof with corrugated tin covering, and timber fascias carrying plastic guttering. The roof was supported on suspended joists with little bracing blocks. There was a work bench attached to the internal face of the north wall and an imprint in the wall above suggests there was a hood above the bench. The west wall was plain, but had had bays painted onto it to demarcate the external storage of materials (Thuran 80, M.O.80 and EP2). Above this hand-painted signage was a red and white enamelled sign reading 'No Smoking No Naked Lights'.
- 29.1.8 There were 12 pairs of principal rafters fabricated from 'I' section RSJs supported by the posts, which were of identical section. The rafter bosses and wall plates were bolted to the sides of the post heads. The south wall was of concrete block fill between the RSJ posts. A fire escape door towards the east end looked to have been inserted into a former larger opening, as indicated by the surviving over-sized lintel. The internal walls were painted a dark grey/blue up to c.0.45m from the floor, and then white above.
- 29.1.9 In the centre of the shed there were four evenly spaced diesel refuelling pumps. The three roads through the shed were separated by concrete aprons which had been finished to the top of the rails, with the centres of the tracks lying at the base of the rails outside of the pumps, and in deep inspection pits between the pumps. The pits had been lit by encased strip lighting housed within insets in the pit walls at close intervals. Perspex covers attached to the outside of the pit wall further shielded the lamps from accidental damage. Internal walkways were situated to the outside of the outer roads and to the south of the middle road, all at the height of the top of locomotives. 'Curtains' fabricated from corrugated tin sheets divided the three bays at high level, and must have been intended as smoke hoods. Towards the western end of the building there were two sets of refuelling pipes and valves between the pits. These were signed 'No Smoking, No Naked Lights'.

Plate 19.1: East end of Building 19
Plate 19.2: West end of Building 19



Non-listed Built Heritage Recording at Old Oak Common, Acton Event Code XSU10
C254-OXF-T1-RGN-CRG05-50001rev2

Plate 19.3: West end of Building 19

Plate 19.4: North-east corner of Building 19

Plate 19.5: Interior looking east

Plate 19.6: General view of interior

Plate 19.7: End of building Plate 19.8: East side of interior



Plate 1



Plate 2



Plate 3



Plate 4



Plate 5



Plate 6



Plate 7



Plate 8



30. STRUCTURE 21: BOILER HOUSE FOR PULLMAN SHED AND LIFTING SHOP

30.1.1 Introduction and summary

30.1.2 This was a large, rectangular, double-height building situated towards the south-west corner of the site and immediately west of the former Sand Furnace (Structure 20). It was also located at the corner of a prominent junction on the entrance track into the site.

30.1.3 The building was clearly a relatively modern construction and it was probably built in 1979 as the boilers inside have makers dates from this year. The structure acted as a boiler house for the Pullman Shed and Carriage Lifting Shop (Structures 22 & 23) immediately to the south.

30.1.4 The DDBA assessed this building as being of negligible significance. It was recorded in the current works at EH Level 1.

30.1.5 Description

30.1.6 **Exterior:** The south elevation contained four adjoining full-width doors with roller shutters, and a higher bay to the west covered in a louvred panel (*Plate 21.1*). The height differential between the doors and louvred bay was filled with vertical bars. All doors and the bay were surmounted by a corrugated steel panel, above which there was a steel fascia. The structure was of brown brick in stretcher bond. The remaining elevations were featureless, excepting for louvred timber pedestrian doors in the western and eastern walls. The north wall carried two small apertures with concrete sills and lintels, through which broad diameter ducts fed a large diameter, free-standing steel stack (*Plate 21.2, 21.3*).

30.1.7 Attached to the north-eastern corner was a metal cage with simple corrugated panels to the roof and western and northern sides. A steel sign attached to the cage doors warning of highly flammable LPG indicated the store's purpose. As the nearest wall to the site entrance, a collection of vinyl and steel signs were affixed to the south-western corner of the building. These provided warnings, directions or speed limits (5 mph). Three carried the stylised animal head logo and name of EWS.

30.1.8 **Interior:** Internally, the building was a single open space which housed three large boilers with maker's plates dating them to 1979 (B+E Boilers Ltd). Six boxed-in north-south RSJs were carried on brick piers and supported a flat roof with roof lights and vents operated by wires and simple pulley wheels (*Plate 21.4*). Other details included the electrical control boxes and cabinets, various compressors and pipework. A corrugated panel clad box sat on the north-eastern corner of the roof and presumably housed a water tank or machinery. Double timber doors on the south elevation gave access to this small, roof-top structure.

Structure 21 Plates

Plate 21.1: View looking north-east

Plate 21.2: North side of building

Plate 21.3: View looking south-west

Plate 21.4: Interior of building



**Non-listed Built Heritage Recording at Old Oak Common, Acton Event Code XSU10
C254-OXF-T1-RGN-CRG05-50001rev2**



Plate 1



Plate 2



Plate 3



Plate 4



31. **STRUCTURE 30: TOILET BLOCK/OFFICE/MESS ROOM**

31.1.1 **Introduction and summary**

31.1.2 The brick built toilet block was located immediately to the west of the 1904-6 'Stores' building (Structure 16), thus being situated on the footprint of the eastern side of the former Engine Shed. The building is later than a plan of the new diesel depot surveyed in 1966 (WSHC 2525/410/2172) and it was probably constructed in the 1970s.

31.1.3 The DDBA assessed this building as being of negligible significance. It was recorded in the current works at EH Level 1.

31.1.4 **Description**

31.1.5 The structure, of light brown brick in a stretcher bond, had a flat roof with a timber fascia board and was divided between a large room at the northern end of the building and several smaller rooms at the southern end. Access was via two doorways in the east wall of the building (the northern one with a roller shutter) and a sign on this wall stated that the southern door gave access to a Laundry Room, Ladies Toilet and Smoking Room. A single window in this wall had a uPVC frame. A small structure on top of the flat room was clad in roofing felt and presumably housed a water tank.

31.1.6 The southern rooms were latterly used as a laundry, ladies toilet and drivers'/shunters' mess room. There were three large Crittal-type frame windows in the western elevation, together with a door, now boarded-up, with a single, closed window above with wired glass, and two high-level windows, also boarded-up, that lit toilets. The northern room appeared to have been used as an office. The northern and southern walls were featureless.

Structure 30 Plates

Plate 30.1: north end of west elevation of Building 30

Plate 30.2: West side of building

Plate 30.3: East side of building



Plate 1



Plate 2



Plate 3



32. STRUCTURE 36: SUBSTATION B3, PREFABRICATED ELEMENT

32.1.1 *Introduction and summary*

32.1.2 At the western end of the south elevation of the Carriage Lifting Shop (Building 23) were a small group of electricity substation structures that collectively formed Building 36. The oldest part of these is a brick structure which was recorded at level 2 and therefore has been described above while to the east of the group was a detached structure constructed from pre-fabricated metal panels. This later structure was almost certainly constructed in the last quarter of the 20th century.

32.1.3 The DDBA assessed that the detached structure formed from pre-fabricated metal panels was of negligible significance. It was recorded in the current works at EH Level 1.

32.1.4 *Description*

32.1.5 This was a very simple, single storey building with a rectangular plan and formed from grey prefabricated panels. Within the panels there were two doorways in the south wall and a double door in the east wall. The east wall also had a single door. There were no windows and the building had a very shallow double-pitched roof. It was not possible to access the interior of the substation during the recording.



33. STRUCTURE 38A: SUBSTATION B5

33.1.1 Introduction and summary

33.1.2 This substation was located in the far south-western corner of the site. The fabric and design of the structures suggest that they were constructed in the latter decades of the 20th century, the brick structures apparently built slightly earlier than their metal counterpart.

33.1.3 It was recorded in the current works at EH Level 1.

33.1.4 Description

33.1.5 The substation consisted of two small single-storey structures built of red brick in a stretcher bond. The southern building was the slightly longer of the two; both were aligned in an approximately northeast-southwest direction parallel with the concrete boundary retaining wall. Both also had a flat roof with a timber fascia board on all four elevations, were windowless and were accessed by a pair of timber double doors. Between and in front (east) of the two buildings was a metal fence which restricted access to two large transformers. To the north of this group was a small, grey single-storey pre-fabricated metal structure with a very shallow sloping roof and a pair of metal double doors in its south elevation. Warning signs on the doors of this building indicated that its purpose was also to house equipment associated with high voltage electricity.



34. **STRUCTURE 52: BUNDED WASTE OIL TANK**

34.1.1 Introduction and summary

34.1.2 This structure lay to the east of the Office/Stores (Structure 16b), and immediately to the north of the sump oil interceptor (Structure 24). A rectangular structure in this position is shown on the 1955 Ordnance Survey map, but a likelier provenance is suggested by its appearance on a British Railways (WR) plan from 1962 (2515/410/1781).

34.1.3 It was recorded in the current works at EH Level 1.

34.1.4 Description

34.1.5 This large steel, cylindrical tank was mounted over an above-ground bund and set on three red brick piers within the bund. The bund was of four courses of concrete blocks treated to an internal render, sat on a concrete base. The tank, which was of later 20th-century date acted in tandem with the sump oil interceptor (Structure 24) which was of more interest and the railings that surrounded it could have been part of Churchward's Edwardian complex.



35. STRUCTURES 34 AND 54: OIL TANKS AND PUMPHOUSE

35.1.1 Introduction and summary

35.1.2 The Fuel and Heating Oil Tanks (34) and the Diesel/oil Tank Pump House (54) were located at the eastern end of the north elevation of the Pullman Shed. Both structures probably date to the end of the 20th century and the DDBA assessed the buildings as being of negligible significance. It was recorded in the current works at EH Level 1.

35.1.3 Description

35.1.4 The Fuel Oil Tanks consisted of two tall cylindrical steel tanks seated side by side within a concrete block wall that acted as a bund. The western tank had a vertical ladder fixed to its west side giving access to the top of both tanks, which were provided with handrails. The pumping equipment was housed within a small steel panelled shed adjacent to the base of the tanks.



36. SALVAGE ITEMS AND OUTSTANDING ITEMS

36.1 Salvage items

36.1.1 Throughout the pre-demolition and demolition phases OA/Ramboll provided guidance on the salvage of items of historic interest at the complex, most of which had previously been identified in the DDBA as being worthy of retention and/or reuse, either at Old Oak Common or elsewhere. The principal feature to be salvaged was the turntable. This was recorded separately

36.1.2 OA Ramboll's salvage recommendations were set out in document C254-OXF-W-RGN-CR076-50001. The items recommended for potential salvage or reuse were:

- One of three composite trusses from The Factory and/or from the Stores building
- Cast iron column and loadspreading steel from The Stores
- Cast-iron pulley wheels from Stores
- Teak flooring in Building 23 reused wedge blocks from Mansell wheels
- Cast-iron railings from Building 24 (sump oil interceptor)
- Metal door at west end of substation (Building 26)
- Diesel oil unloading jib at Building 6 & 53
- Timber apex truss from Building 17a
- Window from original south wall of engine shed (in Building 20)
- Weigh scales from Steam raising plant (Building 5)
- No.49 points lever in Locomotive Shunting Yard
- Large external clock on east wall of Stores (Building 16)
- Important Lifting Tackle' sign on west wall of Building 16
- Gantry cranes from Buildings 15 and 23
- Urinals from Building 23

36.1.3 OA Ramboll was not responsible for managing or monitoring the salvage although some further recording was undertaken on items which were removed and stored temporarily on site for potential reuse. OA Ramboll was not involved in the process of identifying bodies or repositories which could take the items and the current document does not attempt to record which items actually were salvaged successfully or where they are now.

36.2 Outstanding project requirements

36.2.1 The current document forms the final historic building recording report on Old Oak Common. Further archiving and other works to complete the project are required, comprising:

- Lodging copies of the final report with the Local Studies Library and the NMR ;
- Preparation of a summary sheet for the Greater London Sites and Monuments Record;
- Preparation of a 500 word summary report for publication within *London Archaeologist* or other appropriate publication;



Non-listed Built Heritage Recording at Old Oak Common, Acton Event Code XSU10
C254-OXF-T1-RGN-CRG05-50001rev2

- Completion and issue of OASIS form; and
- Submission of the project archive to the Museum of London (LAARC)



37. DISCUSSIONS AND CONCLUSION

- 37.1.1 The modernity of the GWR's Old Oak Common locomotive depot when it opened was, in the words of Hawkins and Reeve, 'fully deserving of a widespread and detailed coverage in the technical press' (Hawkins and Reeve 1987, 41). Described by these authors as the product of the 'Churchward 'leap frog' of absorbed technical experience' the depot was significant for its provision, finally, of facilities that allowed much heavier repairs than had hitherto been possible at Westbourne Park, and for those facilities for the first time to be gathered in one place in a logical and well-ordered manner. It was, to quote Hawkins and Reeve again, 'a quite extraordinary step' (Hawkins and Reeve 1987, 39). But the word 'extraordinary' needs to be seen in context. The GWR had neglected to update their 'outstation' repair facilities, so that by the time George Jackson Churchward assumed control in 1902 it was 'decades behind their rivals' (Hawkins and Reeve 1987, 2). Although complacency and self-satisfaction are likely culprits it would be interesting to know why the GWR's facilities had fallen so far behind their competitors, and what arguments Churchward advanced to persuade them to resume investment. Hawkins and Reeve have observed that 'his political might within the company must have been formidable indeed' (Hawkins and Reeve 1987, 4). Foremost surely of Churchward's arguments must have been the efficiencies to be gained by carrying out repairs 'on site' as it were, thereby removing the need for inefficient movements to and from Swindon.
- 37.1.2 In a departure from prevailing wisdom within the GWR, Churchward took and adopted what was best in existing practice, from wherever in the world it occurred, and used it 'in a flexible and open-minded way' (Hawkins and Reeve 1987, 2). By 1902, of course, railways were a mature industry whilst all of Churchward's predecessors had had in their own way to be pioneers. Churchward was particularly struck by the height of the North Eastern and Midland engine sheds, which he felt removed some of the corrosive effects of coal smoke, and he made sure that his new engine sheds also had high and airy roofs. Probably scarred by the difficulties inherent in a site as cramped as Westbourne Park, he was careful to select sites that offered the opportunity for later expansion, siting his new sheds 'almost as a military campaign' (Hawkins and Reeve 1987, 3). Electric power, then still in its infancy, was used extensively, most obviously in the Lifting Shop where the 30-ton traversing crane from Vaughan & Son Ltd of Manchester was electrically powered. So too were the four Ransome and Rapier turntables, although this appears to have been an afterthought.
- 37.1.3 Churchward was fortunate that the pinnacle of his career coincided with a period when the development of the railway industry, perhaps for the first time, paused for breath. What worked well was universally understood; bad or inefficient practice had largely been banished. The technological advances that would demand a new round of experiment and failure were still some years in the future, and the national demand for railway services was very well charted. Fully understanding what would be required of the new depot enabled Churchward to preside over a design that was clear and confident; one is struck by its simplicity. The design successfully translated process into form.



- 37.1.4 Churchward was also the first Locomotive, Carriage and Wagon Superintendent to pursue standardisation in a meaningful way. He wanted Old Oak Common to serve as a template for others that were to follow, and the depot's pattern was still evident in facilities that were being constructed twenty years later. Stourbridge, for example, had a square engine shed with a single turntable of 29 spokes. A repair shop was attached to its north-eastern corner, and a stores and office building to its south-eastern corner. This depot was built in 1926, although it needs to be acknowledged that its building programme had been set back 10 years by the war (Lyons 1972, 142).
- 37.1.5 Whilst he was alive to the possibilities of change, Churchward also continued with much that was standard GWR practice. For example, Old Oak Common's buildings were of red brick, embellished with round-nose blue engineering bricks, and roofed with slate. This was a style that had been employed in the GWR's station at Truro (rebuilt in 1897), and Westbury station and Truro East signal box (both erected in 1899). The company process of manual coaling of locomotives was also deemed adequate, although other companies using similar coals had moved to mechanical handling.
- 37.1.6 However, although Old Oak Common was justifiably seen as the superior of LNWR's neighbouring Willesden, and it was when it opened the first and largest of a major series of new locomotive depots for the GWR, it needs to be viewed in the context of what other companies had already achieved. It was up-to-date, but outshone only what had gone before it in the GWR canon. The flourishing of engine sheds into stables and repair shops was well underway in America, for example,
- 37.1.7 Old Oak Common's chief significance may have lain in its reflection of where the GWR found itself as the Edwardian period dawned. A certain sense of superiority lingered in the company empire, and it was still an instinctively conservative one. The timber and iron main roof design is highly distinctive, with a long pedigree from the work of Brunel. On the face of it Churchward appeared keen to break with tradition, but in practice it could be argued that he was happy to continue with what worked in order to concentrate his efforts in bringing the GWR into line with the best practice on offer at its competitors.
- 37.1.8 Parts of Churchward's Old Oak Common depot managed to survive the widespread cull of his buildings that occurred as a result of the British Transport Commission's Modernisation Plan. It was certainly his sole surviving heavy-lifting repair shop when it closed in 2010. It had become, partly by virtue of being the last to survive, a site of considerable interest in the fields of 20th-century industrial archaeology and the history of London's transport network. It was for this reason that the standing elements of the depot were assessed in the DDBA to be of regional significance.
- 37.1.9 Although none of the buildings on the site were Listed, the works reported on briefly in this report have produced a valuable permanent record of this important site prior to its demolition. Of particular interest were the structures which survived from the original complex, such as the Factory, the Stores and the Sand Furnace. The project has enhanced our understanding of the complex and complements the detailed historical research on the site previously undertaken for the DDBA, as well as the important collection of historical plans of the site.



Non-listed Built Heritage Recording at Old Oak Common, Acton Event Code XSU10
C254-OXF-T1-RGN-CRG05-50001rev2



APPENDIX 1 BIBLIOGRAPHY AND REFERENCES

- | | | |
|-------------------------------|------|---|
| Arup | 2010 | <i>Old Oak Common Worksites Site Specific Archaeological Written Scheme of Investigation</i> , CR-EG-00C-EN-SP-00001 Rev 3.0 |
| Crossrail | 2012 | <i>Heritage Items for Disposal Salvaged from Old Oak Common Depot</i>
: Document No. C160-XRL-T1-GPD-CRG03-50001 |
| Forsythe HG | 1981 | <i>Steam Shed portrait</i> |
| Hawkins, C
and Reeve,
G | 1987 | <i>An Illustrated History of Great Western Railway Engine Sheds</i> |
| Leigh, C, | 1993 | <i>The Heyday of Old Oak Common and its Locomotives</i> |
| Lyons, E | 1972 | <i>An Historical Survey of Great Western Engine Sheds 1947</i> , Oxford
Publishing Co |
| OA Ramboll | 2010 | <i>Non-listed Built Heritage Recording at Old Oak Common, Acton:
Archaeology Method Statement</i> , C254-OXF-W-GMS-CRG03-00004 Rev 4.0 |
| PCA | 2010 | <i>Old Oak Common Worksites Archaeological Detailed Desk-Based
Assessment: Non-Listed Built Heritage</i> , C150-CSY-T1-RGN-CR076_PT001-
00011 Rev 4.0 |
| Spooner A | 1986 | <i>Old Oak Engineman</i> |
| Tucker M | 2010 | <i>The 'Factory' Building (former locomotive lifting shop) at Old Oak Common
Railway Depot – its significance</i> (unpublished paper by Engineering
Historian) |

APPENDIX 2 SUMMARY OF SITE DETAILS AND OASIS REPORT

Client name: Crossrail Ltd

Site name: Old Oak Common Train Maintenance Depot: Non-listed built heritage recording

Site code: XSU10

Grid reference: TQ 2187 8239

Type of evaluation: Historic Building Recording

Date and duration of project: The main site recording was undertaken intermittently on many days between 12 November 2010 and 3 March 2011. Further isolated recording was also undertaken on 19 May 2011 and 25 October 2011.

Area of site: Old Oak Common Train Maintenance Depot, Acton, London Borough of Hammersmith and Fulham, NW10.

Summary of results: The site comprised c.34 individual buildings or structures, all of which were of 20th-century date and related directly to the railway depot. The most significant were those which survived from the original depot constructed in c.1904-6 and included the Stores, the Factory and the sand furnace.

Location of archive: The archive is currently held at OA, Janus House, Osney Mead, Oxford, OX2 0ES, and will be deposited with the Museum of London in due course.



APPENDIX 3 LASER SCAN AND DIGITALSURVEY FILES

Laser scan data exists as a large folder of .pod files. These are accessed using PoinTools Pro ©. Free viewers are also available but are unable to manipulate the data.

CAD sections and plans (.DWG files) have been extracted from the .pod survey data. These are commensurate with the appropriate Level of recording (I, II or III) required for each structure at the OOC complex. These will be deposited with LAARC in adherence to LAARC'S standards for deposition of CAD data.

The Laser survey scan data will be retained by OA and can also be copied to Crossrail. It is not currently clear whether LAARC will accept .pod survey data, however it can be packaged along with a free viewer onto DVD and deposited with the site archive. This will be discussed with LAARC at the time of deposition.