



C261 EARLY EAST
Built Heritage Recording Report Level 2
Albion Brewery Well

Document Number: C261-MLA-X-RGN-CR140-50099

Document History:

Revision:	Date:	Prepared by:	Checked by:	Approved by:	Reason for Issue:
1.0	18.06.12	[REDACTED] (MOLA)	[REDACTED] (MOLA)	[REDACTED] (MOLA)	For Crossrail Review
2.0	19.07.12	[REDACTED] (MOLA)	[REDACTED] (MOLA)	[REDACTED] (MOLA)	Includes comments from review document C261-MLA-X-XCS-CR140-50007
		[REDACTED]	[REDACTED]	[REDACTED]	



CROSSRAIL REVIEW AND ACCEPTANCE STATUS		
This decal is to be used for submitted documents requiring acceptance by CRL.		
<input checked="" type="checkbox"/>	Code 1.	Accepted. Work May Proceed
<input type="checkbox"/>	Code 2.	Not Accepted. Revise and resubmit. Work may proceed subject to incorporation of changes indicated
<input type="checkbox"/>	Code 3.	Not Accepted. Revise and resubmit. Work may not proceed
<input type="checkbox"/>	Code 4.	Received for information only. Receipt is confirmed
Reviewed/Accepted by:(signature)	[REDACTED]	
Print Name:	[REDACTED]	Date: 28 TH AUGUST 2012
Acceptance by CRL does not relieve the designer/supplier from full compliance with their contractual obligations and does not constitute CRL approval of design, details, calculations, analyses, test methods or materials developed or selected by the designer/supplier.		

This document contains proprietary information. No part of this document may be reproduced without prior written consent from the chief executive of Crossrail Ltd



Contents

1 Introduction	5
2 Site Methodology and fieldwork objectives	6
2.1 Recording methodology	6
2.2 Fieldwork Objectives	6
3 Historical introduction to the structure	7
The Albion Brewery	7
3.1 A note on artesian boring.....	9
3.2 Artesian wells	9
4 Analytical description of the well.....	11
5 Conclusion	13
5.1 Original research aims	13
5.2 Archiving.....	13
5.3 Publication	13
5.4 Acknowledgements	14
Bibliography.....	15

Figure list

Fig 1 Site location plan

Fig 2 Section of the well (from Crossrail C121-MMD-C-DDL-D061-57101)

Fig 3 The upper part of the well (from Crossrail C121-MMD-C-DDL-D061-57104)

Fig 4 OS map, Whitechapel, Spitalfields & the Bank 1873, London Sheet 63

Fig 5 The OS Map 1948, London Sheet 63 the well is below the cross-hatched glazed roof in the centre of the site below the words "Albion Brewery"

Fig 6 The façade of the Albion Brewery, c 1900.

Fig 7 View of the basement room containing the well, looking south (08512001)

Fig 8 Drain space to the south of the well (08512012)

Fig 9 The brick steps abutting the well, looking north-west (08512010)

Fig 10 View of the well from above (08512022)

Fig 11 The upper part of the well and the inspection door, looking east (08512024)

Fig 12 Remnant equipment at the bottom of the upper part of the well (08512027)

Fig 13 Staircase leading to the inspection door (08512034)

Fig 14 The access to the basement room containing the well (08512036)

Fig 15 Sketch drawings based on notes made on site

Fig 16 Sketch drawings based on notes made on site

List of tables

Table 1 Albion Brewery listing details

8

1 Introduction

This report presents the results of the survey and recording work undertaken by MOLA on the Albion Brewery Well, which is part of the Whitechapel Station Crossrail site – package C261 Early East. Whitechapel Station, located to the north of Whitechapel Road within the London borough of Tower Hamlets (Fig 1), is currently undergoing major redevelopment works due to the construction of a new cross-London link by Crossrail. Whitechapel Station site can be divided into three sub-sites: Cambridge Heath Road Worksite, Durward Street Worksite and Essex Wharf Worksite (including the Durward Street Shaft and Interchange).

The well is part of the Cambridge Heath Road site which includes the Albion Brewery building (Listed Building Grade II, Listing NGR: TQ3488581917) (NGR 34880 81929) facing onto Whitechapel Road at 333–335 and is close to the junction with Cambridge Heath Road. The well, located in the basement at the rear of the building, was constructed as part of the Brewery and is the last remaining piece of equipment of the site hence the requirement for its recording.

In accordance with the Environment Agency guidelines for decommissioning of redundant boreholes and wells and to offset the risk of ground movements and collapse on the site, the Albion Brewery Well will be in-filled up to the bottom level of the upper shaft (C140-HYD-T-RGN-D061-00008 version 4.0). Consent for the infilling of the Albion Brewery Well was obtained, Ref THA/3/1/H.

The fieldwork was carried out in accordance with:

- A Crossrail Site-specific Written Scheme of Investigation (SS-WSI): C140 – Whitechapel Station Written Scheme of Investigation, Doc. No. C140-HYD-T1-JLT-D061-0000, version 4.0
- An Addendum to Method Statement Whitechapel Station: Built Heritage Recording Level 2, Albion Brewery Well (XSH10) Doc. No. C261-MLA-A-RGN-CR140-50003
- Submission of Particulars Under Appendix 2 of Heritage Deed: Albion Brewery Well C140-HYD-T-RGN-D061-00008 version 4.0

In addition to the fieldwork, the off-site analytical study and the reporting in this document comply with the relevant guidelines from the Institute for Archaeologists, (IFA 1996), English Heritage (EH 1991), Royal Commission of Historical Monuments, England (RCHME 1996), the Museum of London Archaeology Health and Safety Policy (MOLA 2008), and the Museum of London Archaeology Service site manual (MoLAS1994).

All fieldwork was conducted on the 09/02/2012 and supervised by Patrizia Pierazzo (MOLA Standing Building Archaeologist).

The event code (sitecode) is XSH10.

2 Site Methodology and fieldwork objectives

2.1 Recording methodology

The mitigation strategy for potential settlement or ground movements caused by the backfilling of the well is preservation by record. The well is part of the Grade II Listed Albion Brewery building. The well is considered to be a heritage asset of importance, and required recording to Level 2 of the English Heritage specifications (English Heritage, 2006), as specified in section 5.4 of Doc. No. C140-HYD-T1-JLT-D061-00001, version 4.0. Consent obtained for infilling of the well was Ref THA/3/1/H.

The recording of the structure to Level 2 (fieldwork) consisted of:

- annotated sketches made during an on-site analysis of the structure, with attention paid to areas of alteration and repair
- a photographic record including general and detailed shots taken by the MOLA photographic team, as well as photographs taken by the Standing Buildings team as an aid to off-site analysis.

The fabric of the structure underwent visual analysis on site, with the analysis continuing after the fieldwork, and an appropriate level of documentary archive research was carried out, accessed through online sources and MOLA's own library.

Interventions into the fabric of the structure or the removal of samples of fabric were not required.

2.2 Fieldwork Objectives

The overall objective and aims of the recording were to secure preservation by record of the 19th century-well prior to its backfilling. This was to achieve a level 2 record in accordance with the specification set out in the English Heritage Guidelines (EH 2006). The fieldwork undertaken and the office based off-site work have produced the requisite results in the form of this report and the associated archive.

- As specified in the Addendum to the method statement: Doc. No. C261-MLA-A-RGN-CR140-50003, section 2, the objectives of the investigation were identified as follows:
- To investigate the fabric of the structure before demolition, alteration or refurbishment, with the aim of elucidating its structural history, and record and analyse the resulting evidence for this history using applicable archaeological methods.
- To make a record of the existing building in its present condition, by means of photography, measured survey where necessary and annotated sketches.
- To carry out an appropriate level of documentary research in order to give a written account of the structure.
- To report the results in suitable form in accordance with Crossrail requirements, and archive the records.

This report gives a brief written and illustrated description of the structure, analysis of its fabric, its history and use with site photographs and sketch drawings reproduced. This report and the site drawings and photographs will be archived under the site code XSH10.

3 Historical introduction to the structure

The Albion Brewery

The Albion Brewery, built in 1808 by Richard Ivory, was one of several major breweries and distilleries established in East London during the first half of the 19th century. Richard Ivory was the landlord of the Blind Beggar and the Brewery was built on land previously occupied by Ivory's old brewhouse. The site was accessed through a set of large gates to the side of the Blind Beggar tavern; beyond there was a shop, house and almshouses. As a result, the Brewery did not originally have a frontage directly onto Whitechapel Road as it does today. The brewhouse was subsequently acquired by James Mann in 1826 (Pevsner, 2005).

The beer trade expanded rapidly after the removal of the beer duty in 1830 and as a result of the improvement of the transport links with East Anglia and Kent, where the hops and grain were produced (Pevsner, 2005). As a consequence, other breweries from a similar period were established in East London, and include the Truman's Black Eagle Brewery on Brick Lane, the St George's brewery of 1847 on Commercial Road and the huge Ind Coope Brewery at Romford. Most of these breweries have now been demolished, and those that survive have ceased to produce beer.

In 1844 the Metropolitan Building Act prescribed that noxious industries had to be moved outside the metropolis, therefore after that date new industries set up outside London, but the old ones survived until they ceased production. The new location for these industries included the Isle of Dogs, Bow Creek, Silvertown, Bromley-by-Bow, Old Ford and Stratford (Pevsner 2005).

The original building of the Albion Brewery, built at the beginning of the 19th century, was demolished 50 years later and a new one rebuilt in 1860–8, (Fig 4) possibly by E.N. Clifton for Mann, Crossman & Paulin, the owners of the brewery at the time (Fig 6 **Error! Reference source not found.**). The brewery's new building engineer was Robert Spence, who also rebuilt the adjoining Blind Beggar public house in 1894 and presumably he also engineered the Artesian well at the rear of the new brewery building. As mentioned by Pevsner, the imposing frontage of Mann Crossman & Paulin's Albion Brewery 172 Whitechapel Road has been retained, including an 'energetic relief of St George and the Dragon'.

In the 1860s, the consumption of porter began to decline and lighter sparkling ales, became more popular. The Company decided to follow the trend and built a further brewery also called the Albion Brewer, at Burton-on-Trent. Eventually it was discovered that the water of the East End was perfect for use in the brewing of these lighter ales, and as a result production moved to London in 1897. Further expansion came when Mann, Crossman & Paulin and Company bought the old Whitechapel Workhouse in Ravens Row, on the south side of Whitechapel Road, close to the Brewery, and built a bottling plant to meet the growing demand for bottle beers. By 1900 beer production had reached nearly 500,000 barrels and in 1901 Mann, Crossman & Paulin become a public company.

The building achieved fame during the Siege of Sidney Street in 1911, when fugitives who had killed a policeman fled to a flat at 100 Sidney Street, opposite the Company's bottle plant in Ravens Row. During the siege a wounded policeman was carried into the bottling plant where his wounds were dressed before being taken to the Royal London Hospital. Members of the Scots Guards were positioned on the

high water tower of the bottling plant in order to get a clear shot into the house, which eventually caught fire and the criminals perished inside.

During the Second World War the Albion Brewery had its own Home Guard contingent and fire fighting unit. As the East End came under nightly attack the Brewery suffered bomb damage and the stables took a direct hit, killing and injuring some of the shire horses within.

In 1959 the Company merged with Watney, Combe, Reid and Co. to form Watney, Mann. Then in the early 1970s a frantic period of mergers and acquisitions was underway in the brewing industry, which saw the closure of many of London's historic breweries. In 1972 the Watney, Mann Company was bought by Grand Metropolitan who closed the Albion Brewery in 1979. The building was converted into flats by Peter Brooks Associates in 1993-4. The north portion of the brewery extending along Brady Street was cleared for the construction of Sainsbury's in 1993-94.

The Albion Brewery building is currently a Listed Building Grade II (see table below for listing details).

Table 1 Albion Brewery listing details

Listing description - Albion Brewery (entrance Block)	
Grade	II
Date Listed	27 September 1973
English Heritage Building ID	206360
OS Grid Reference	TQ3488581917
OS Grid Coordinates	534885, 181917
Latitude/Longitude	51.5201, -0.0573
Location	Whitechapel Road, Poplar, Greater London E1 1EW
Locality	Stepney
Local Authority/County:	Greater London
Country:	England
Postcode:	E1 1EW
<p>WHITECHAPEL ROAD E1 4431 (North Side) Albion Brewery (Entrance Block) TQ 3481 15/515 II 2.</p> <p>Early C19 with alterations and additions. Eastern block to Whitechapel Road of stock brick, white stone cornice and bands. Roof not visible. 4 storeys, 6 windows set in double brick arches, those of top floor blank. Unbarred sashes. Walls connect with gate piers with white stone caps. Wrought iron overthrow. Main entrance recessed. Stock brick, brown and white stone. Carriageway with round arch under broken pediment. Decorated tympanum with name 'Albion Brewery'. Fluted Ionic pilasters and 3 round headed windows with architraves on 1st floor. Pediment</p>	

surmounts building. Entrance lodge, white stone, inside outer Gateway.

Listing NGR: TQ3488581917

Source: English Heritage

3.1 A note on artesian boring

Boring through the natural geology for water in London was used extensively in the past. Many buildings built during the second half of the 19th century were supplied by artesian wells, including the Albion Brewery. Among others were the Houses of Parliament, the Bank of England, the fountains in Trafalgar Square and many of London's prisons.

Chalk formations are amongst the strata where water is found more successfully and this includes the London basin where the chalk layer has been exploited extensively for boring. Although the general aspect of chalk varies with its condition, the uniformity of chalk as a rock formation is one of its most remarkable characteristics. It admits everywhere the percolation of water, receiving into itself and conveying to its lower bed the water that falls on its surface. The chalk formations repose on a bed of tough clay called Gault, which prevent the water from passing down to the underlying layers of sand.

It has been found that by far the greatest portion of the rain which falls upon the chalk formations, encountering no impervious bed, continues to descend through the various fissures until arrested under the bed of Gault's clay lying beneath the chalk; the water fills the lower cavities and accumulates to such a height as to force its way through the subterranean passages connecting to the sea.

When the water basin accumulation (aquifer) gets overcharged by further rain and flood water, hydrostatic pressure starts to build up. In these conditions, boring from the surface to the level where the water is stored caused water to ascend through the borehole and to flow to the surface or to a height where it can be conveniently pumped to the surface.

3.2 Artesian wells

An artesian well, which the Albion Brewery well is an example, is bored through the impermeable strata to reach the water bearing layer below. The water is forced upward by means of hydrostatic pressure as a result of the higher level at which the main or supplied water was received. A well drilled through a pressurised aquifer will cause the water to gush to the surface naturally (De Villiers, 2001). Such wells, known as flowing wells were discovered in Flanders and England in the early 12th century.

Artesian wells are supplied by waters that flow from a completely different location to that of surface wells. Common surface wells obtain water from shallower strata like sands, gravels, other porous beds which depend directly on rainfall, hence the irregularity of the supply.

Artesian wells were at the centre of extensive debate during the 19th century, when some people refused to call an artesian well a 'well' if it would not raise water to within 40 feet of the surface. It was also suggested in 1852 that there were no true artesian wells within three miles of St Paul's (Beames, T, 1852), which would include the Albion Brewery.

As a result there are specific criteria that apply to the definition and building of an artesian well:

- The orifice of the bore must be below the level of that part of the water-bearing stratum which crops out on the surface
- The water must be contained between two impermeable strata
- The strata must take the form of a basin, alternatively the outflow must be so far impeded as to keep the water at an elevation higher than the orifice of the bore.

An artesian well can be of a flowing type or non-flowing type and while two wells can derive their supply from the same source, minimal differences in the location of the well can affect the amount of pressure bringing the water to the surface.

The name artesian derives from the province of Artois in the north-east of France where during the 13th century, thanks to the invention of percussion drills, four 100 metre deep wells were bored into the fractured chalk below.

Other well-known examples of artesian wells bored in the 19th century are the Trafalgar Square fountains created in 1844, whose water was fed by an artesian well and pumped up by a steam engine located behind the National Gallery. Although severely criticized for malfunctioning and supplying foul water, the same artesian well fed the Royal Palaces and a few public buildings in the west-end. By 1900 water supply from artesian wells in the London area became so ineffective it was replaced by mains water supply.

4 Analytical description of the well

Albion Yard is located on the ground floor of the Albion Brewery Entrance Block (nos 333-335 odd) on Whitechapel Road. The remaining floors of the building are taken up by domestic properties. The Albion Brewery lies adjacent to the Blind Beggar public house (no. 337), near to junction of Whitechapel Road and Cambridge Heath Road (Grid ref TQ 34880 81929). The well is located within a rectangular basement room, measuring 5.6m x 5.27m (Figs 5 and 7). Above this at ground floor level are white ceramic faced bricks on the exterior of the building, while a large black composite beam, which has been cut, indicate the extent of a former room that housed well equipment.

The west wall of the basement room, of breeze blocks, is a relatively recent partition sub-dividing an originally larger room, possibly the boiler room, containing the well and – most likely – the steam engine attached to it.

The walls of the basement room are lined with cream colour glazed tiles from floor level to ceiling. Parts of the original ceiling appear to survive along the east and north side walls, leaving a void, at present covered by concrete slabs, in the middle of the room (Fig 7). The ceiling is likely to have been glazed and the OS map of 1948 depicts a glazed roof over the well house (Fig 5).

The metal trough ceiling is supported on two main I-section joists, running north-south and east-west, which form a cross to the north-east of the well. The north-south joist still retains fixtures like brackets and hooks likely to have been used as support for equipment (Fig 16).

The north-east corner of the basement room containing the well is occupied by a staircase (Fig 13) leading to an inspection door located at 3m below the top of the well (Fig 10 and Fig 11). The staircase access is protected at floor level by a metal handrail with a circular terminal. Three shallow steps located along the east side of the well give access to the top of the well.

An Allen West & Co. autotransformer of unknown date hangs along the north wall, where several bars and brackets project also from the wall, suggesting that pieces of equipment were formerly hung there.

The well is a circular feature (Fig 7), which projects from the floor of the basement room for 0.46m, 0.82m on the deeper part of the basement room. It has a diameter of c 2.65m and is built with an assemblage of metal panels regularly bolted together. Each panel measures 1.52m x 1.42m and have 7 bolts along each side. The well is partially covered by wooden decking (at present 2.40m in length and 0.65m in width) possibly recently cut by the contractor (visible in Fig 8).

The well is formed of an upper and wider section, which ends at 4.3m below the top of the well, and a lower and narrower section, also called the main shaft, which has a depth of 57.8m (Fig 2 and Fig 3) (C140-HYD-T-RGN-D061-00008 version 4.0). Below the main shaft an unlined borehole has an approximate depth of 125m.

The inspection door, cut through the metal panels, allows closer observation of the wider upper section of the well than from the top (Fig 9 and Fig 11).

At the bottom of the upper section (Fig 10 and Fig 12), remnant bars and brackets suggest the former presence of water lifting equipment, possibly the bucket lifting device.



The basement room containing the well is accessed through an arched opening located along the southern wall, and facing onto a corridor (Figs 14 and 15). The opening appears to have been cut into the panels in order to become an entrance into the room. It is likely that the original entrance into the boiler room was located elsewhere.

In July 2011 a further artesian well was recorded by MOLA approximately 5 to 10m to the north of the present site. This second well was within the area of former Albion Brewery buildings demolished in the 1990s. (Sankey, 2011, Sitecode XSH10 Document Ref C261-MLA-X-RGN-CR140-50041 the reader should refer to this document for a full description).

5 Conclusion

The historic well on site is undoubtedly of considerable significance, associated with the use of the building as a brewery representing the first step in beer production by obtaining the water and it may also represent some of the last remaining equipment relating to the brewery. The survey of the Albion Brewery well produced a record of the accessible areas of the well in its immediate surroundings. Although often underestimated with regards to its historical interest, the extraction of water in traditional breweries had a pivotal role in the production of beer which attributes historical value to the survival of the artesian well at the former Albion Brewery.

5.1 Original research aims

The programme of archaeological investigation has enabled a record of the structure to be produced, to English Heritage Level 2, and produced an appropriate record of it prior to its infill.

The initial objectives of the investigation were satisfied as follows:

The fabric of the structure has been investigated prior to loss. It has been possible to assess that the building of the well was executed in a single phase and no alterations affected its structure since the date of construction.

It has been possible to make a record of the well. The structure has been recorded photographically, by measured survey and by annotated sketches while all accessible areas have been included in the survey.

It has been possible to carry out the necessary amount of documentary research, as appropriate to the level of recording and to provide a written account of the structure

The results are here reported in a suitable form in accordance with Crossrail requirements, and the archiving of the records is detailed below.

5.2 Archiving

A copy of this report and all of the photographic images taken on site can be found under the site code XSH10 in the MOLA archive. They will be stored there pending a future decision over the longer-term archive deposition and public access process for the wider Crossrail scheme.

5.3 Publication

The results of the survey will initially be disseminated via this report and the supporting site archive of finds and records (including digital data). Any publication proposals will be considered in relation to later fieldwork at the Whitechapel Station site, and also the wider context of archaeological potential and results across the Crossrail scheme.

This report will be made available from The London Archaeological Archive and Research Centre (LAARC) in due course.

A summary report will be published in the London Archaeologist excavation round up, and also deposited with the LAARC.



5.4 Acknowledgements

The archaeological survey and this report were commissioned by the Crossrail Project Archaeologist, [REDACTED], whom MOLA wish to thank. They are grateful especially to [REDACTED] for facilitating access to site and to [REDACTED] for his help.

The Built Heritage survey was carried out and this report were produced by Patrizia Pierazzo, professional photographs were taken by Maggie Cox and the graphics in this report were prepared by Juan Jose Fuldain. The MOLA Contracts Manager was Elaine Eastbury.

Bibliography

This list includes works consulted as well as those cited in the text.

- Crossrail, C140 – Whitechapel Station Written Scheme of Investigation, Doc. No. C140-HYD-T1-JLT-D061-00001, version 4.0
- Crossrail, An Addendum to the Method Statement Whitechapel Station: Built Heritage Recording Level 2, Albion Brewery Well (XSH10), Doc. No. C261-MLA-A-RGN-CR140-50003
- Crossrail, Submission of Particulars Under Appendix 2 Of Heritage Deed: Albion Brewery Well C140-HYD-T-RGN-D061-00008 version 4.0
- De Villiers, M., 2001, Water: The Fate of Our Most Precious Resource, p 43 and p 55
- English Heritage, 1991, Management of archaeological projects (2nd edition)
- English Heritage (Greater London Archaeological Advisory Service), 1998, Archaeological guidance papers
- English Heritage, 2006, Understanding historic buildings: a guide to good recording practice (Swindon: English Heritage)
- English Heritage, 2008, Conservation principles: policies and guidance
- IFA [Institute for Archaeologists], 1996, Standard and guidance for archaeological investigation of standing buildings or structures (revised 2001)
- MOLA [Museum of London Archaeology], 2012, Health and safety policy
- Museum of London, 1994 Archaeological site manual (3rd edition)
- Pevsner, N, 2005, The buildings of England, London 5: East
- RCHME [Royal Commission on Historical Monuments, England], 1996, Recording historic buildings: a descriptive specification
- Sankey, D., 2011. C261 Archaeology Early East Fieldwork Report Archaeological Watching Briefs and Evaluation, Whitechapel Shaft XSH10 Document Number: C261-MLA-X-RGN-CR140-50041. Crossrail Report
- Beames, T, 1852The Rookeries of London, [online] Available at <http://www.victorianlondon.org/publications5/rookeries-15.htm> [Accessed 09 February 2012]
- THE TRAFALGAR SQUARE FOUNTAINS. HC Deb 26 August 1889 vol 340 cc478-9 [online] Available at <http://hansard.millbanksystems.com/commons/1889/aug/26/the-traffic-square-fountains> [Accessed 09 February 2012]
- Wright, J., 2011, 33–35 Commercial Road (formerly St George’s Brewery) Whitechapel London E1, A Standing Buildings Survey Report.



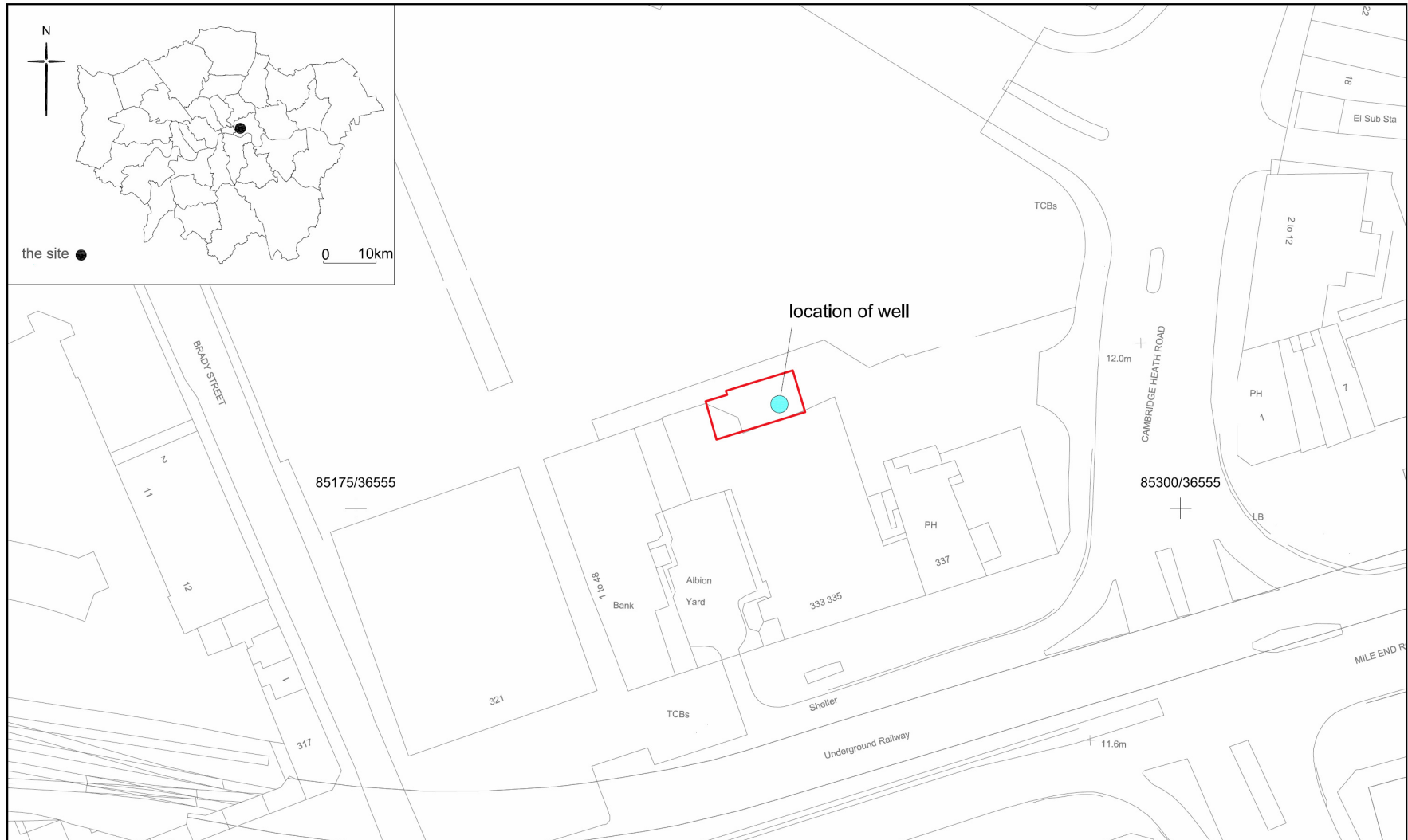

Fig 1 Site location

Site outline
 Artesian well

0 1:800 @ A4 50m

Based upon the Ordnance Survey mapping with the permission of the Controller of Her Majesty's Stationery Office © Crown Copyright. Unauthorised reproduction infringes Crown Copyright and may lead to prosecution or civil proceedings. TFL 100032379 2010.

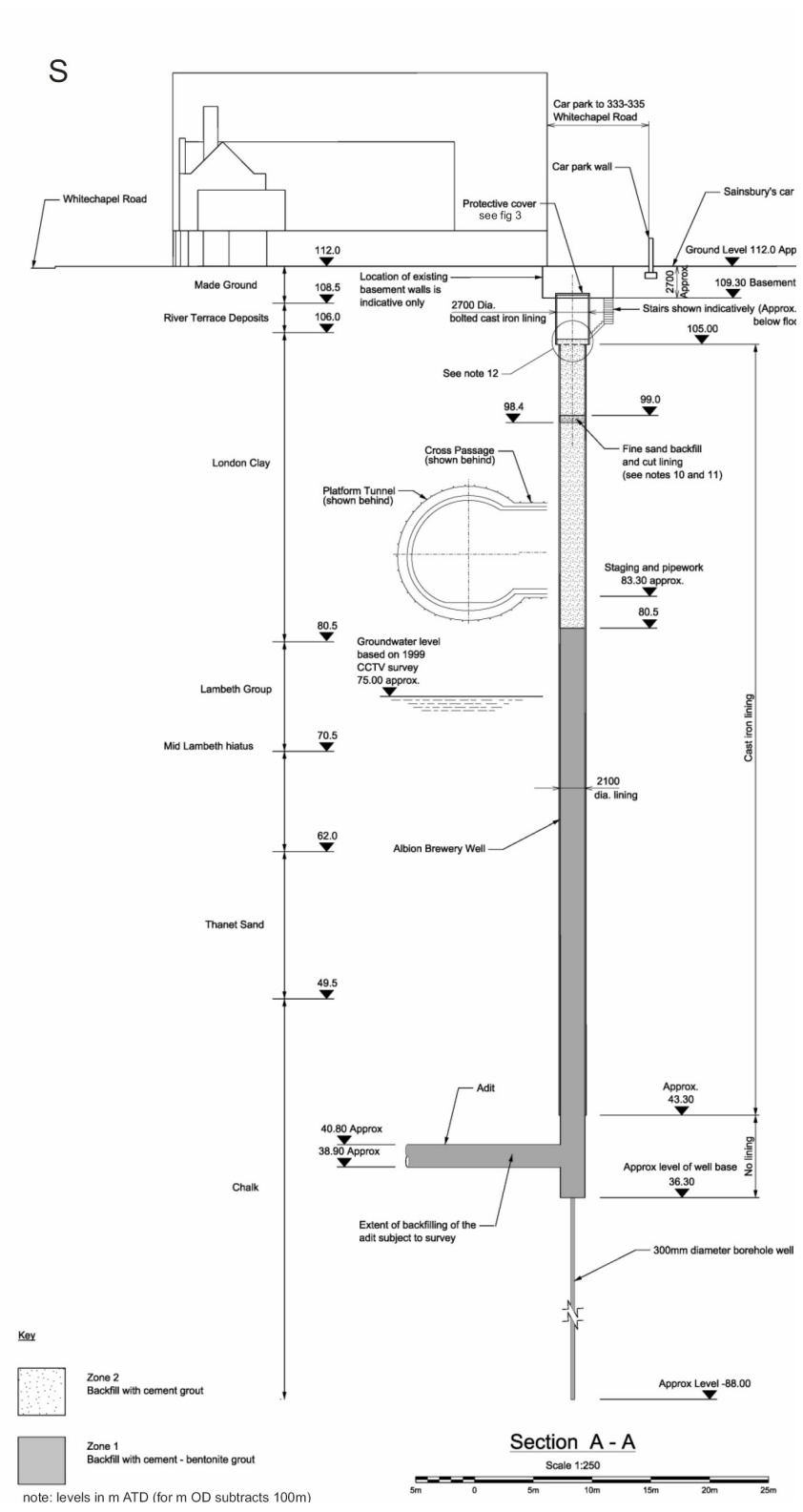
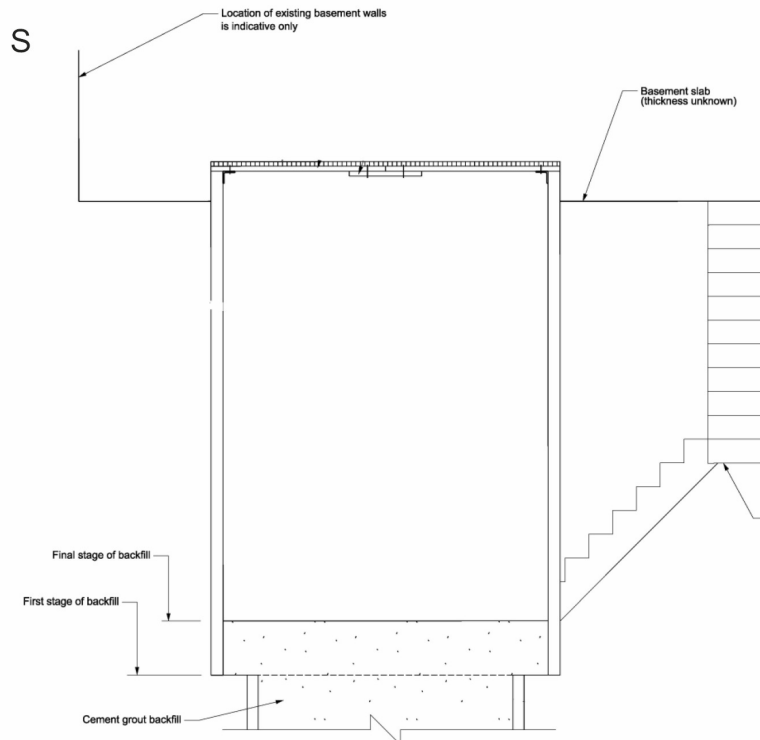
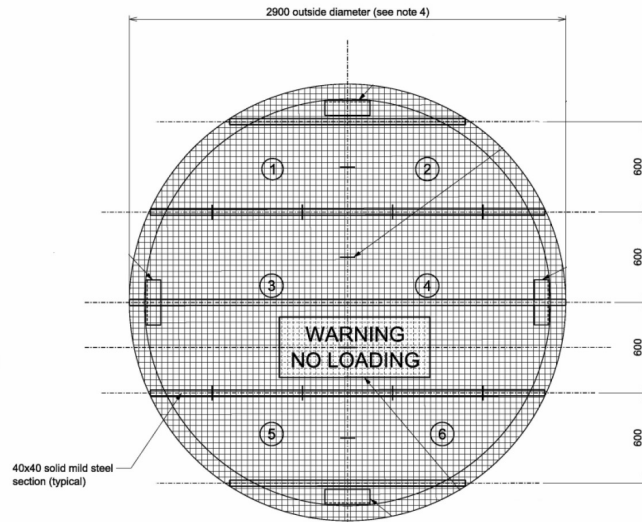

Fig 2 Section of the well (from Crossrail C121-MMD-C-DDL-D061-57101)



Detail at Top of Cast Iron Lining

Scale 1:25



Plan View Showing Protective Cover

Scale 1:25

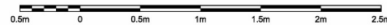

Fig 3 The upper part of the well (from Crossrail C121-MMD-C-DDL-D061-57104)



Fig 4 OS map, Whitechapel 1873, London Sheet 63

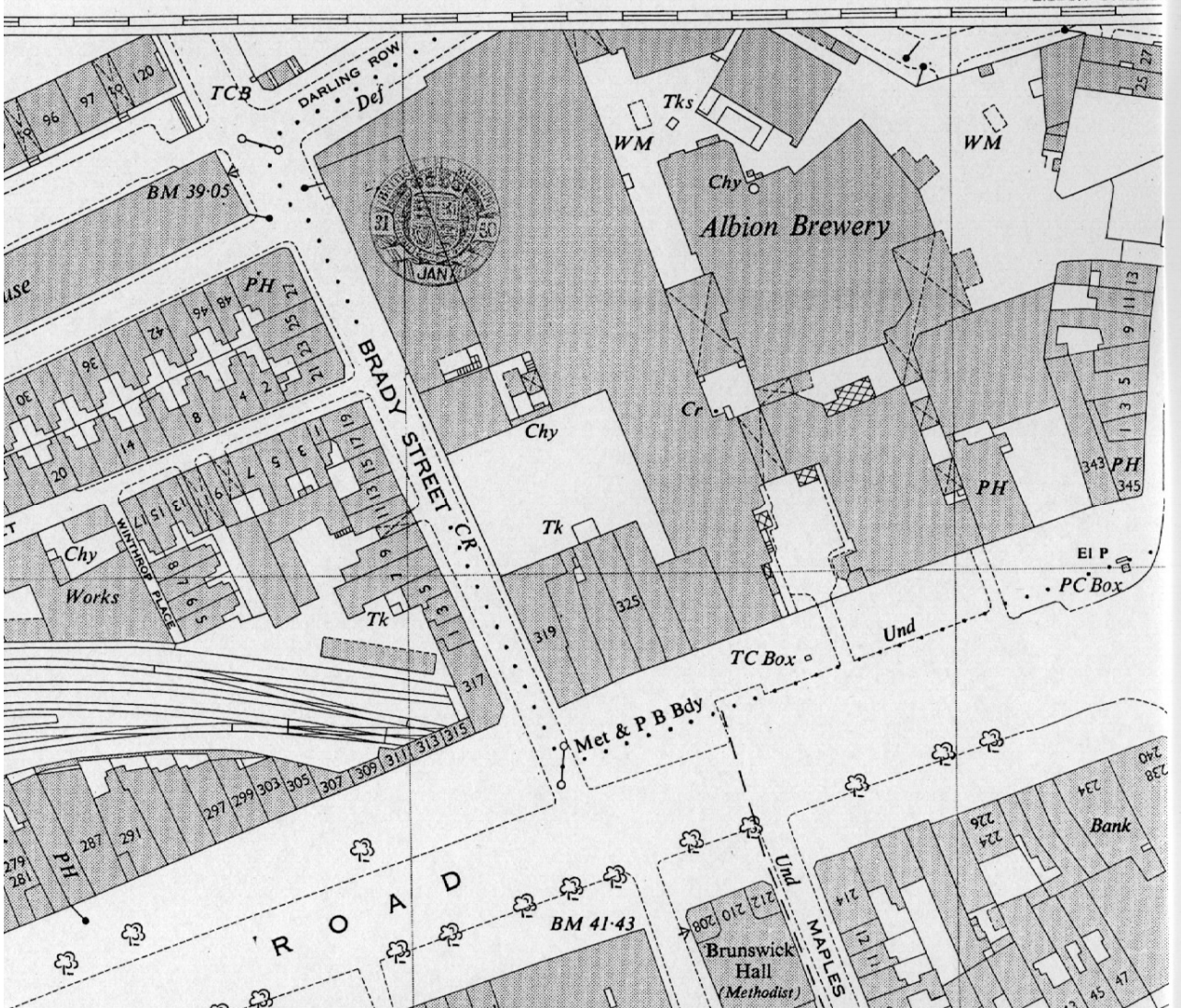

Fig 5 The OS Map 1948, London Sheet 63 the well is below the cross-hatched glazed roof in the centre of the site below the words "Albion Brewery"



Fig 6 The façade of the Albion Brewery, c 1900.
(<http://www.eastlondonpostcard.co.uk/POM2004/Aug04.htm#top>)



Fig 7 View of the basement room containing the well, looking south (08512001)



Fig 8 Drain space to the south of the well (08512012)

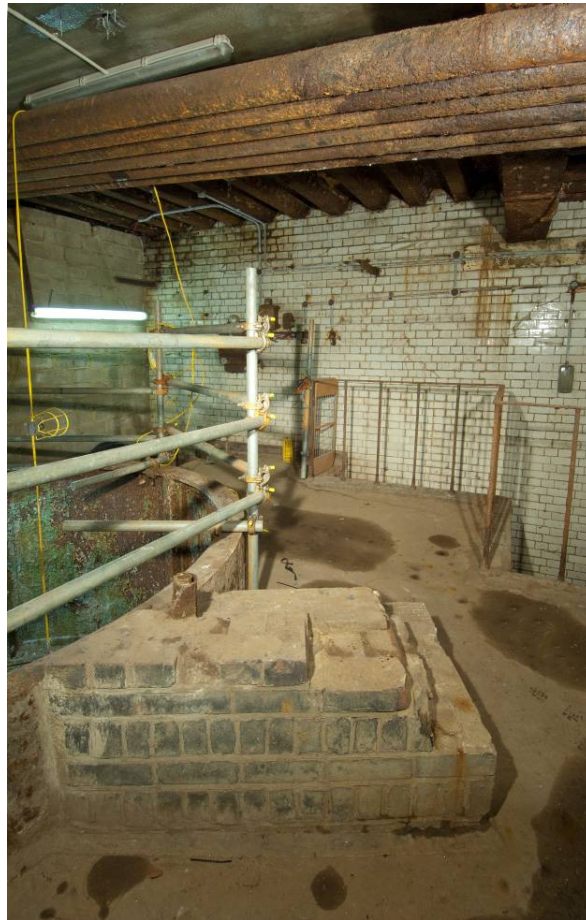

Fig 9 The brick steps abutting the well, looking north-west (08512010)



Fig 10 The view of the well from above (08512022)



Fig 11 The upper part of the well and the inspection door, looking east (08512024)



Fig 12 Remnant equipment at the bottom of the upper part of the well (08512027)

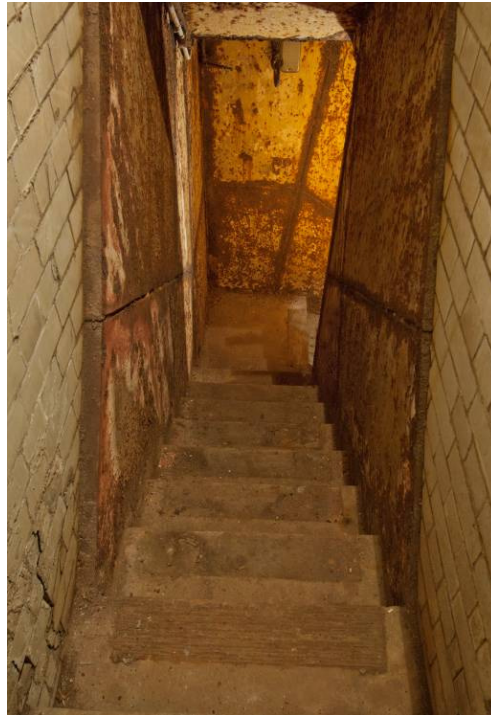

Fig 13 Staircase leading to the inspection door (08512034)



Fig 14 The access to the basement room containing the well (08512036)

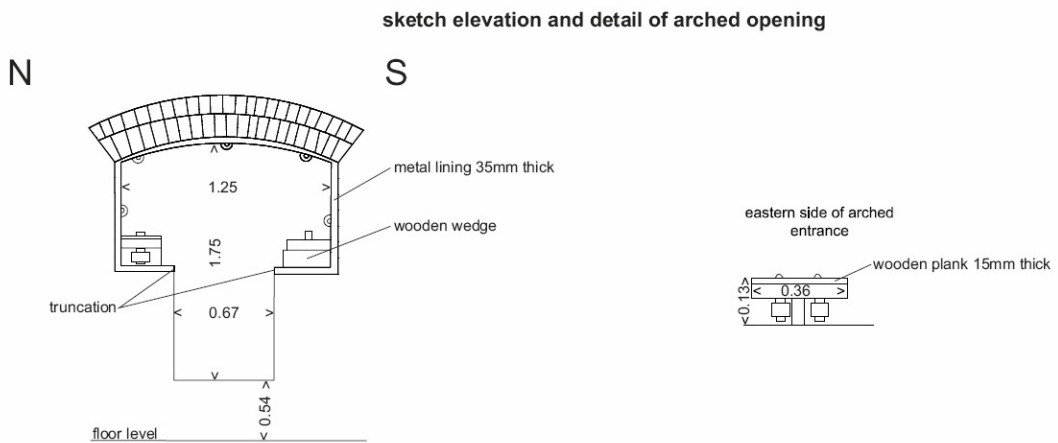
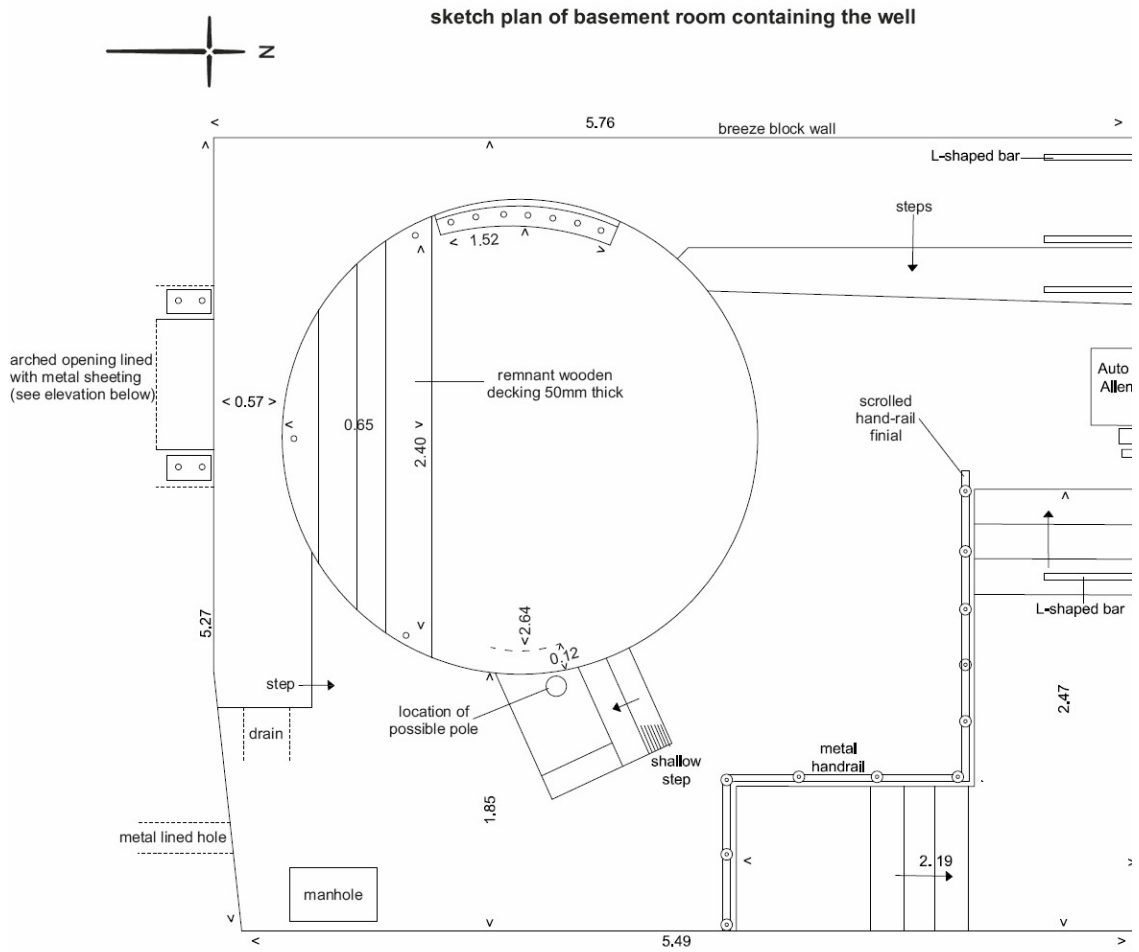
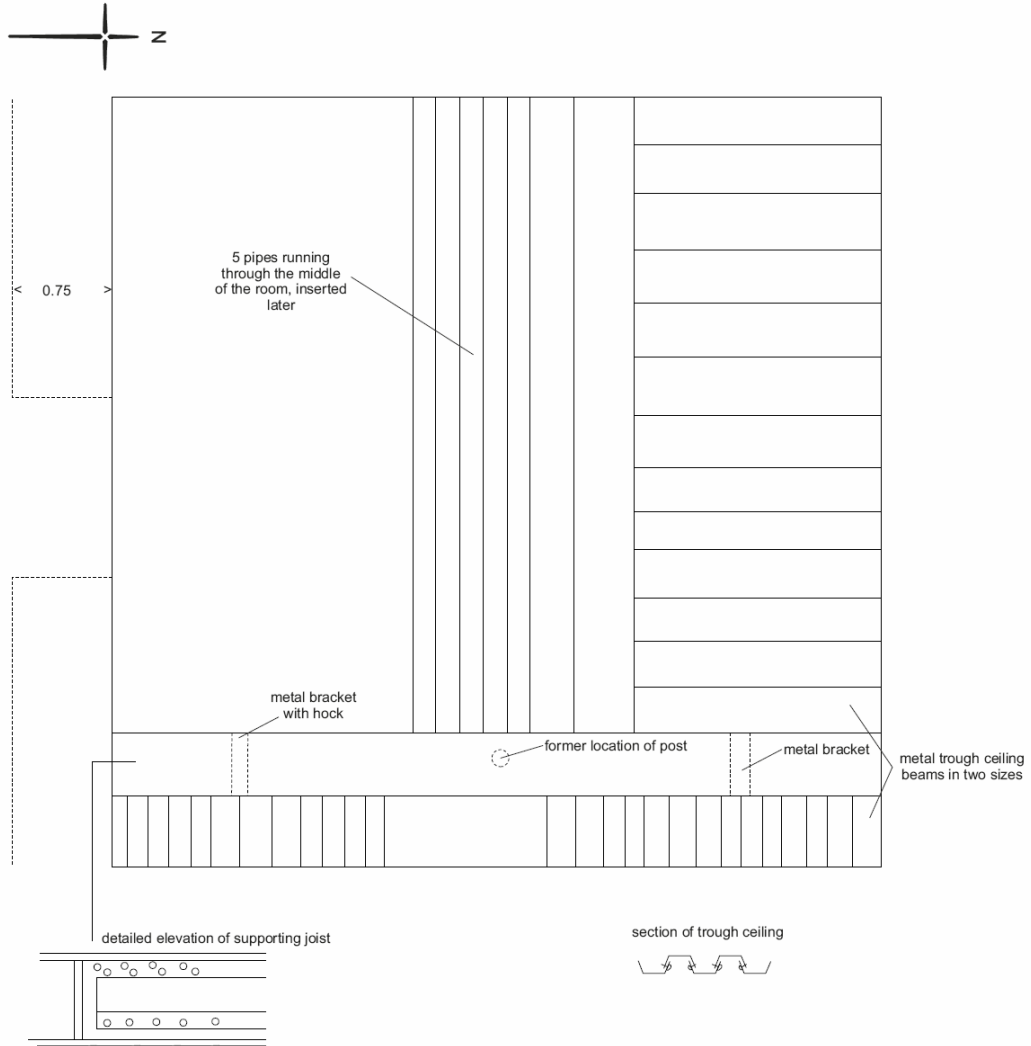

Fig 15 Sketch drawings based on notes made on site

sketch plan of basement room ceiling



cast iron well lining
 details of the well panel

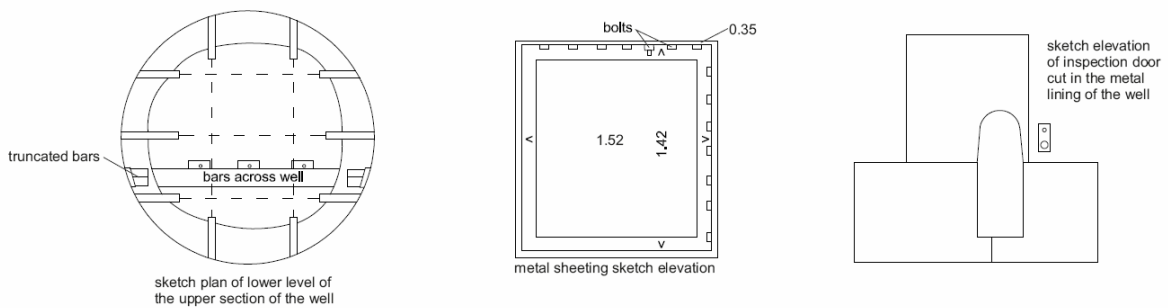

Fig 16 Sketch drawings based on notes made on site