



Work Area: SMM
Work Type: I&M
Originator Company: GEOCISA

C435 Farringdon Main Station

CRL Lead reviewer: [Redacted]
CRL Reviewer:

Monitoring Close-Out Report: Levelling Points Installed on St John St. CRL Document Number: C435-BFK-C2-RGN-M123-51637

Supplier Document Number: N/A
Contract MDL reference C13.012

1. Contractor Document Submittal History:

Revision:	Date:	Prepared by:	Checked by:	Approved by:	Reason for Issue:
1.0	18-05-2016	[Redacted]	[Redacted]	[Redacted]	For acceptance
2.0	16-08-2016	[Redacted]	[Redacted]	[Redacted]	For acceptance

2a. Stakeholder Review Required? YES NO

Stakeholder submission required: LU RIL Purpose of submission: For no objection
 NR LO For information
 DLR Other: _____

This document has been reviewed by the following individual for coordination, compliance, integration and acceptance and is acceptable for transmission to the above stakeholder for the above stated purpose.

Sign: _____ Role: _____ Name: _____ Date: _____
 Sign: _____ Role: _____ Name: _____ Date: _____

2b. Review by Stakeholder (if required):

Stakeholder Organisation	Job Title	Name	Signature	Date	Acceptance
					<input type="checkbox"/>
					<input type="checkbox"/>
					<input type="checkbox"/>

compliance with their contractual obligations and does not constitute ds or materials developed or selected by the designer/supplier.

3. Acceptance by Crossrail:

[Redacted Signature]

14/11/2016

Contents

A.	INTRODUCTION	3
B.	INSTRUMENTS	3
B.1	DESCRIPTION OF THE INSTRUMENTS	3
B.2	LOCATION OF THE INSTRUMENTS	6
C.	MOVEMENTS	6
C.1	MOVEMENTS RESULTING FROM CONSTRUCTION ACTIVITIES	6
C.1.1	Relevant Crossrail (BFK) Works	6
C.1.2	Resulting Movements	7
C.2	TRIGGER BREACHES	10
C.3	SIGNIFICANT ISSUES WITH THE INSTRUMENTATION	11
C.4	RESIDUAL RISKS	11
D.	CONCLUSIONS	11
APPENDI A: DRAWINGS.		
APPENDI B: GRAPHS.		
APPENDIX C: GLOSSARY.		

A. INTRODUCTION

In line with the C122 – M&W Specification KX10 – Instrumentation & Monitoring C122-OVE-4-RSP-CR001-00007, this Close-Out Report aims to address the following points in relation to the instrumentation defined in Section B.

- Identify movements observed by the relevant instruments;
- Relate these movements to construction activities, where applicable;
- Identify trigger breaches that may have occurred;
- Demonstrate that the rate of change of the data is either in line with the required rate or such that residual risks are minimal;
- Identify any such residual risks should there be considered to be any.

Based on the above points, this close out reports will provide justification for the decommissioning of the instruments.

B. INSTRUMENTS

B.1 Description of the Instruments

This Close-Out Report relates the sockets and studs installed on St John St. See Table 1 below with the details of the sockets, and Table 2 with the details of the studs

Sensor	Location	Easting (m)	Northing (m)	Elevation (mATD)
C435-LB13157	3-5 St John St	82144.336	36538.528	115.3922
C435-LB13155	3-5 St John St	82137.0120	36537.193	115.432
C435-LB13156	3-5 St John St	82141.3540	.3537.684	115.3716
C435-LB13165	7-9 St John St	82144.929	36559.599	115.6735
C435-LB13166	11-33 St John St	82143.717	36573.209	115.9715
C435-LB13167	11-33 St John St	82143.053	36603.779	116.6882
C435-LB13172	20-26 St John St	82170.503	36595.836	116.5617
C435-LB13173	20-26 St John St	82170.426	36590.794	116.4009
C435-LB13174	20-26 St John St	82170.623	36589.184	116.4572
C435-LB13175	20-26 St John St	82168.381	36586.091	116.3911
C435-LB13176	20-26 St John St	82167.982	36584.375	116.2078
C435-LB13177	20-26 St John St	82166.221	36581.691	116.0977
C435-LB13178	20-26 St John St	82165.361	36579.469	116.2991
C435-LB13179	20-26 St John St	82162.273	36574.969	116.1612
C435-LB13180	16 St John St	82161.480	36573.010	115.8424
C435-LB13181	16 St John St	82160.286	36567.790	115.6335
C435-LB13182	12-14 St John St	82158.791	36561.841	115.5351
C435-LB13183	16 St John St	82158.782	36561.334	115.5556
C435-LB13184	12-14 St John St	82158.114	36553.891	115.4948
C435-LB13185	8-10 St John St	82157.797	36549.805	115.577
C435-LB13186	8-10 St John St	82157.184	36546.012	115.5865

Sensor	Location	Easting (m)	Northing (m)	Elevation (mATD)
C435-LB13187	2-6 St John St	82157.149	36543.732	115.5639
C435-LB13188	2-6 St John St	82157.979	36534.220	115.5799
C435-LB13189	2-6 St John St	82158.399	36528.693	115.6192
C435-LB13800	11-33 St John St	82142.510	36582.264	116.9283
C435-LB13801	11-33 St John St	82142.282	36593.058	116.94
C435-LB13802	11-33 St John St	82142.154	36598.433	116.9498
C435-LB13812	3-5 St John St	82146.604	36540.910	116.5369
C435-LB13813	3-5 St John St	82146.303	36544.501	116.5344
C435-LB13814	3-5 St John St	82145.999	36548.113	116.5624

Table 1: Details of the sockets

Sensor	Easting (m)	Northing (m)	Elevation (mATD)
C435-LP13187	82145.680	36601.824	116.24
C435-LP13188	82145.749	36596.844	116.1303
C435-LP13189	82146.206	36591.864	116.0178
C435-LP13190	82146.347	36586.882	115.8938
C435-LP13191	82146.378	36581.869	115.8078
C435-LP13192	82146.652	36577.488	115.6966
C435-LP13193	82146.705	36571.933	115.5979
C435-LP13194	82147.075	36565.865	115.4935
C435-LP13195	82147.190	36560.584	115.4153
C435-LP13196	82147.260	36555.923	115.342
C435-LP13197	82147.246	36550.935	115.3088
C435-LP13198	82147.603	36545.302	115.243
C435-LP13199	82147.700	36540.304	115.209
C435-LP13200	82147.631	36536.464	115.2445
C435-LP13201	82144.458	36523.082	115.5283
C435-LP13202	82143.519	36518.174	115.549
C435-LP13203	82141.605	36513.237	115.5683
C435-LP13204	82167.238	36600.007	116.3874
C435-LP13205	82166.475	36595.072	116.2138
C435-LP13206	82165.074	36590.294	116.2081
C435-LP13207	82163.623	36585.530	116.1205
C435-LP13208	82162.353	36580.682	116.0143
C435-LP13209	82160.901	36575.852	115.8748
C435-LP13210	82160.200	36573.469	115.809

Sensor	Easting (m)	Northing (m)	Elevation (mATD)
C435-LP13211	82159.548	36571.049	115.7254
C435-LP13212	82158.966	36568.638	115.6353
C435-LP13213	82158.369	36566.176	115.542
C435-LP13214	82157.787	36563.700	115.4527
C435-LP13215	82157.335	36561.229	115.5289
C435-LP13216	82157.089	36558.751	115.5225
C435-LP13217	82156.841	36556.249	115.4942
C435-LP13218	82156.579	36553.780	115.4555
C435-LP13219	82156.431	36551.274	115.4372
C435-LP13220	82156.258	36548.774	115.4015
C435-LP13221	82156.139	36546.267	115.3914
C435-LP13222	82156.057	36543.775	115.3436
C435-LP13223	82155.994	36541.278	115.3545
C435-LP13224	82155.944	36538.761	115.358
C435-LP13225	82155.849	36536.272	115.3665
C435-LP13226	82155.726	36533.781	115.3768
C435-LP13227	82155.729	36531.284	115.4018
C435-LP13228	82155.635	36528.794	115.4198

Table 2: Details of the studs

The sockets and studs on St John St are shown in the following documents:

Drawings:

- C435-BFK-C2-DWG-M123-50043. Sockets installed for Farringdon Station
- C435-BFK-C2-DWG-M123-50044. Studs installed for Farringdon Station.

Installation Report:

- C435-BFK-C-RGN-M123-50137. Installation Report – Manual Precise Levelling Points. Studs, Sockets, and Invar Scales

B.2 Location of the Instruments

The buildings where the sockets and studs are installed are located along St John St. The sockets are installed on the bottom of the façade for the building, and the studs are installed on the ground.

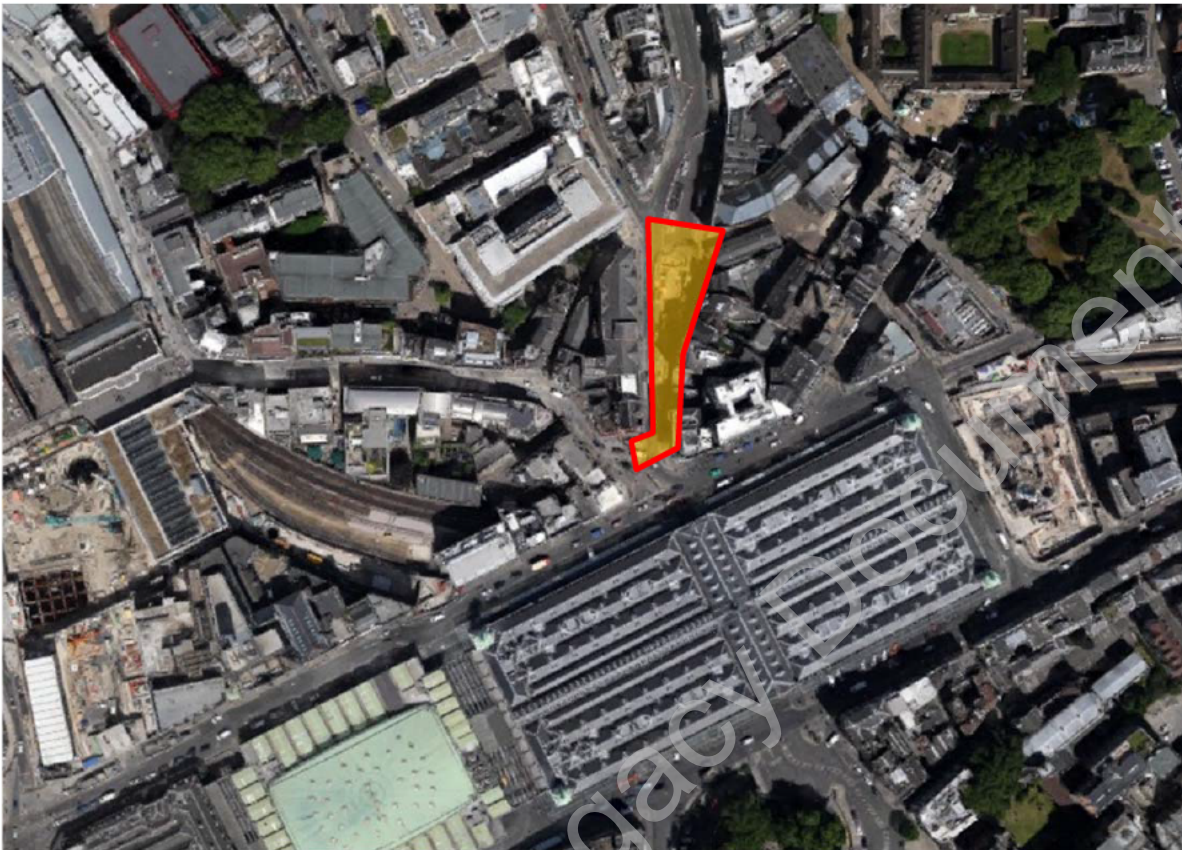

Figure 1 – Plan showing the Location for the sockets and studs

C. MOVEMENTS

C.1 Movements Resulting from Construction Activities

C.1.1 Relevant Crossrail (BFK) Works

The construction activities affecting these instruments are outlined in the Table 3 below:

Activity	Start Date	End Date
EB TBM	16-01-2014	17-01-2014
WB TBM	30-09-2013	03-10-2013
PTE Enlargement	19-08-2014	10-09-2014
PTW Enlargement	27-07-2014	13-08-2014
CP4	13-08-2014	17-09-2014

Table 3 – Construction Activities associated to St John St.

C.1.2 Resulting Movements

To analyse the result for the sockets buildings will be looked at individually:

- 3-5 St John St
- 7-9 St John St
- 11-33 St John St.
- 2-6 St John St
- 8-10 St John St
- 12-14 St John St
- 16 St John St
- 20-26 St John St.

- 3-5 St John St.

The monitoring data for the prism is shown in Appendix B.

- In August 2013 compensation grouting caused 4mm maximum of heave.
- From 16-01-2014 to 17-01-2014 the EB TBM caused maximum 6mm of settlement.
- Residual settlement caused 1-2mm of settlement.
- During July and August 2014 compensation grouting caused 13-14mm maximum of heave.
- Between 19-08-2014 and 10-09-2014 PTE caused 6mm of settlement maximum.
- CP4 construction caused 8-10mm maximum of settlement from 10-09-2014 to 17-09-2016.
- Maximum settlement at the end of the works -23mm

- 7-9 St John St

The monitoring data for this building is shown in Appendix B.

- On August 2013 compensation grouting caused 2-3mm of heave.
- On 16-01-2014 EB TBM caused 2mm maximum of settlement.
- On 05-08-2014 compensation grouting caused 2mm of heave.
- Between 19-08-2014 and 10-09-2014 PTE enlargement caused 8-10mm maximum of settlement.
- Maximum settlement at the end of the works -15mm

- 11-33 St John St.

The monitoring data for this building is shown in Appendix B.

- On 16-01-2014 Eastbound TBM caused 1mm maximum of settlement.
- Between 02-09-2014 and 10-09-2014 PTE works caused 4-5mm maximum of settlement.
- Maximum settlement at the end of the works -5mm

- 2-6 St John St

The monitoring data for this building is shown in Appendix B.

- On 23-08-2013 compensation grouting caused 6-7mm maximum of heave.
- From 01-10-2013 to 03-10-2013 Westbound TBM caused 2mm of settlement.
- Residual settlement caused 2mm maximum of settlement.
- Between 16-01-2014 and 17-01-2014 Eastbound TBM caused 4-5mm maximum of settlement.
- Residual settlement after EB TBM caused 3-4mm of settlement.
- Compensation grouting caused 2mm maximum of heave on 09-08-2014.
- Between 03-08-2014 to 13-08-2014 PTW enlargement works caused 10mm maximum of settlement.
- From 19-08-2014 to 10-09-2014 PTE works caused 7-8mm of settlement.
- Maximum settlement at the end of the works -22mm

- 8-10 St John St.

The monitoring data for this building is shown in Appendix B.

- On 25-08-2013 compensation grouting caused 6-7mm maximum of heave.
- From 16-01-2014 to 17-01-2014 EB TBM caused 4mm of settlement.
- Residual settlement caused 4mm maximum of settlement.
- On 03-09-2014 compensation grouting caused 2-3mm of heave.
- Between 05-09-2014 and 10-09-2014 PTE construction caused 14-16mm maximum of settlement.
- Maximum settlement at the end of the works -23mm

- 12-14 St John St.

The monitoring data for this building is shown in Appendix B.

- Compensation grouting from Moorgate Shaft 1 caused 6-7mm of heave on 23-08-2013.
- On 16-01-2014 EB TBM caused 4-5mm maximum of settlement.
- Residual settlement caused 2mm of settlement.
- From 30-08-2014 to 10-09-2014 PTE works caused 14-15mm of settlement.
- Maximum settlement at the end of the works -22mm

- 16 St John St.

The monitoring data for this building is shown in Appendix B.

- Compensation grouting carried out on 22-08-2013 caused 4mm maximum of heave.
- On 16-01-2014 EB TBM caused 3-4mm maximum of settlement.
- PTE works caused 8-9mm maximum of settlement from 30-08-2014 to 10-09-2014.
- Maximum settlement at the end of the works -18mm

- 20-26 St John St.

The monitoring data for this building is shown in Appendix B.

- 2mm maximum of settlement caused by the EB TBM on 16-01-2014.
- From 30-08-2014 to 10-09-2014 PTE works caused 4mm maximum of settlement.
- Maximum settlement at the end of the works -7mm

To analyse the result for the studs will be separate by sections:

- From C435-LP13183 to C435-LP13193
- From C435-LP13194 to C435-LP13203
- From C435-LP13204 to C435-LP13208
- From C435-LP13209 to C435-LP13228

- **From C435-LP13187 to C435-LP13193**

The monitoring data for this building is shown in Appendix B.

- On 16-01-2014 EB TBM caused maximum 2mm of settlement.
- Between 20-08-2014 and 09-09-2014 PTE works caused 4-5mm maximum of settlement.
- Maximum settlement at the end of the works -8mm

- **From C435-LP13194 to C435-LP13203**

The monitoring data for this building is shown in Appendix B.

- On 24-08-2013 compensation grouting from Moorgate Shaft 1 caused 6-7mm maximum of heave.
- On 30-09-2013 WB TBM caused 4-5mm maximum of settlement.
- On 16-01-2014 Eastbound TBM caused 5-6mm of settlement.
- Residual settlement after the EB TBM caused 2-3mm of settlement.
- On 22-08-2014 compensation grouting caused 7-8mm of heave.
- From 27-07-2014 to 13-08-2014 PTW enlargement caused 10-12mm maximum of settlement
- Between 19-08-2014 and 10-09-2014 PTE works caused maximum 6-8mm of settlement.
- Maximum settlement at the end of the works -28mm

- **From C435-LP13204 to C435-LP13208**

The monitoring data for this building is shown in Appendix B.

- On 16-01-2014 EB TBM caused maximum 2mm of settlement.
- From 01-09-2014 to 10-09-2014 PTE enlargement works caused 2mm maximum of settlement.
- Maximum settlement at the end of the works -4mm

- **From C435-LP13209 to C435-LP13228**

The graph for this group of studs is shown in Appendix B.

- Compensation grouting carried out on 24-08-2013 caused maximum 6-7mm of heave.
- On 02-10-2013 WB TBM caused 2mm of settlement.
- Residual settlement after WB TBM caused 1-2mm of settlement.
- On 15-01-2014 EB TBM caused 3-4mm of settlement.
- Compensation grouting carried out on 19-08-2014 caused 3-4mm of heave.
- From 30-08-2014 to 10-09-2014 PTE construction works caused 14-16mm of settlement.
- Maximum settlement at the end of the works -24mm

C.2 Trigger Breaches

The Instrumentation and Monitoring Plan: Farringdon Station Ground Movement and Asset Protection C122-OVE-C2-RGN-M123-50013 outlines the triggers associated with the works.

Most of the buildings where the sockets and studs are installed are inside the compensation grouting area, so in this case, the triggers criteria for this building is based on the slopes. More references are included in the Close Out Report for Moorgate Shaft 1 C435-BFK-C2-RGN-M123-51608.

No triggers were breached. Table 4 and Table 5 below shows the 10mm default alerts breached.

MONITORING GROUP (Location)	POINT ID	TYPE	DIRECTION	DATE OF LAST READING	LAST READING VALUE (mm)	TRIGGER LEVEL	
						WORST HISTORICAL STATUS	CURRENT STATUS
3-5 St John St	C435-LB13155	BRE SOCKETS	Settlement	18/09/2015 13:00	-23.8	Default Alert	Default Alert
	C435-LB13156	BRE SOCKETS	Settlement	18/09/2015 13:00	-17.35	Default Alert	Default Alert
	C435-LB13157	BRE SOCKETS	Settlement	18/09/2015 13:00	-17.1	Default Alert	Default Alert
	C435-LB13812	BRE SOCKETS	Settlement	04/12/2015 13:00	-18.8	Default Alert	Default Alert
	C435-LB13813	BRE SOCKETS	Settlement	04/12/2015 13:00	-17.7	Default Alert	Default Alert
7-9 St John St	C435-LB13814	BRE SOCKETS	Settlement	04/12/2015 13:00	-20	Default Alert	Default Alert
	C435-LB13165	BRE SOCKETS	Settlement	04/12/2015 13:00	-15.2	Default Alert	Default Alert
11-33 St John St	C435-LB13166	BRE SOCKETS	Settlement	04/12/2015 13:00	-5.4	Default Alert	Default Alert
	C435-LB13167	BRE SOCKETS	Settlement	04/12/2015 13:00	2.8	Default Alert	Default Alert
	C435-LB13800	BRE SOCKETS	Settlement	04/12/2015 13:00	-0.3	Clear	Clear
	C435-LB13801	BRE SOCKETS	Settlement	04/12/2015 13:00	2.5	Clear	Clear
	C435-LB13802	BRE SOCKETS	Settlement	04/12/2015 13:00	3.1	Default Alert	Default Alert
2-6 St John St	C435-LB13187	BRE SOCKETS	Settlement	04/12/2015 13:00	-25.8	Default Alert	Default Alert
	C435-LB13188	BRE SOCKETS	Settlement	04/12/2015 13:00	-23.8	Default Alert	Default Alert
	C435-LB13189	BRE SOCKETS	Settlement	04/12/2015 13:00	-23.1	Default Alert	Default Alert
8-10 St John St	C435-LB13185	BRE SOCKETS	Settlement	04/12/2015 13:00	-22.2	Default Alert	Default Alert
	C435-LB13186	BRE SOCKETS	Settlement	04/12/2015 13:00	-23.4	Default Alert	Default Alert
12-14 St John St	C435-LB13182	BRE SOCKETS	Settlement	04/12/2015 13:00	-17.5	Default Alert	Default Alert
	C435-LB13184	BRE SOCKETS	Settlement	04/12/2015 13:00	-21.6	Default Alert	Default Alert
16 St John St	C435-LB13180	BRE SOCKETS	Settlement	04/12/2015 13:00	-10	Default Alert	Default Alert
	C435-LB13181	BRE SOCKETS	Settlement	04/12/2015 13:00	-13	Default Alert	Default Alert
	C435-LB13183	BRE SOCKETS	Settlement	04/12/2015 13:00	-17.7	Default Alert	Default Alert
20-26 St John St	C435-LB13172	BRE SOCKETS	Settlement	04/12/2015 13:00	2.6	Clear	Clear
	C435-LB13173	BRE SOCKETS	Settlement	04/12/2015 13:00	-0.3	Clear	Clear
	C435-LB13174	BRE SOCKETS	Settlement	04/12/2015 13:00	0.5	Clear	Clear
	C435-LB13175	BRE SOCKETS	Settlement	04/12/2015 13:00	-0.5	Clear	Clear
	C435-LB13176	BRE SOCKETS	Settlement	04/12/2015 13:00	-2.3	Clear	Clear
	C435-LB13177	BRE SOCKETS	Settlement	04/12/2015 13:00	-3	Clear	Clear
	C435-LB13178	BRE SOCKETS	Settlement	04/12/2015 13:00	-2.8	Clear	Clear
	C435-LB13179	BRE SOCKETS	Settlement	04/12/2015 13:00	-8.6	Clear	Clear

Table-4 Triggers breached by the sockets.

MONITORING GROUP (Location)	POINT ID	TYPE	DIRECTION	DATE OF LAST READING	LAST READING VALUE (mm)	TRIGGER LEVEL	
						WORST HISTORICAL STATUS	CURRENT STATUS
St John St	C435-LP13187	PLP	Settlement	04/12/2015 11:00	2.6	Clear	Clear
	C435-LP13188	PLP	Settlement	04/12/2015 11:00	-5.7	Clear	Clear
	C435-LP13189	PLP	Settlement	04/12/2015 11:00	-2.9	Clear	Clear
	C435-LP13190	PLP	Settlement	04/12/2015 11:00	-0.7	Clear	Clear
	C435-LP13191	PLP	Settlement	04/12/2015 11:00	-1.5	Clear	Clear
	C435-LP13192	PLP	Settlement	04/12/2015 11:00	-5.8	Clear	Clear
	C435-LP13193	PLP	Settlement	04/12/2015 11:00	-8.8	Clear	Clear
	C435-LP13194	PLP	Settlement	04/12/2015 11:00	-16.4	Default Alert	Default Alert
	C435-LP13195	PLP	Settlement	04/12/2015 11:00	-18.6	Default Alert	Default Alert
	C435-LP13196	PLP	Settlement	01/06/2015 14:00	-20.4	Default Alert	Default Alert
	C435-LP13197	PLP	Settlement	04/12/2015 11:00	-18.2	Default Alert	Default Alert
	C435-LP13198	PLP	Settlement	04/12/2015 11:00	-19.4	Default Alert	Default Alert
	C435-LP13199	PLP	Settlement	04/12/2015 11:00	-17.2	Default Alert	Default Alert
	C435-LP13200	PLP	Settlement	04/12/2015 11:00	-22	Default Alert	Default Alert
	C435-LP13201	PLP	Settlement	09/06/2015 14:00	-24.7	Default Alert	Default Alert
	C435-LP13202	PLP	Settlement	18/09/2015 13:00	-28.5	Default Alert	Default Alert
	C435-LP13203	PLP	Settlement	09/06/2015 14:00	-29.5	Default Alert	Default Alert
	C435-LP13204	PLP	Settlement	04/12/2015 11:00	-6.5	Clear	Clear
	C435-LP13205	PLP	Settlement	04/12/2015 11:00	-0.3	Clear	Clear
	C435-LP13206	PLP	Settlement	04/12/2015 11:00	0.5	Clear	Clear
	C435-LP13207	PLP	Settlement	04/12/2015 11:00	3.3	Clear	Clear
	C435-LP13208	PLP	Settlement	04/12/2015 11:00	-4.6	Clear	Clear
	C435-LP13209	PLP	Settlement	04/12/2015 11:00	-7.1	Clear	Clear
	C435-LP13210	PLP	Settlement	04/12/2015 11:00	-8.5	Clear	Clear
	C435-LP13211	PLP	Settlement	04/12/2015 11:00	-11.2	Default Alert	Default Alert
	C435-LP13212	PLP	Settlement	04/12/2015 11:00	-12.9	Default Alert	Default Alert
	C435-LP13213	PLP	Settlement	04/12/2015 11:00	-16.4	Default Alert	Default Alert
	C435-LP13214	PLP	Settlement	04/12/2015 11:00	-16.9	Default Alert	Default Alert
	C435-LP13215	PLP	Settlement	04/12/2015 11:00	-18.1	Default Alert	Default Alert
	C435-LP13216	PLP	Settlement	04/12/2015 11:00	-20.6	Default Alert	Default Alert
	C435-LP13217	PLP	Settlement	04/12/2015 11:00	-21.5	Default Alert	Default Alert
	C435-LP13218	PLP	Settlement	04/12/2015 11:00	-23.7	Default Alert	Default Alert
C435-LP13219	PLP	Settlement	04/12/2015 11:00	-23.3	Default Alert	Default Alert	
C435-LP13220	PLP	Settlement	04/12/2015 11:00	-26.9	Default Alert	Default Alert	
C435-LP13221	PLP	Settlement	04/12/2015 11:00	-27.1	Default Alert	Default Alert	
C435-LP13222	PLP	Settlement	04/12/2015 11:00	-24.6	Default Alert	Default Alert	
C435-LP13223	PLP	Settlement	04/12/2015 11:00	-23.9	Default Alert	Default Alert	
C435-LP13224	PLP	Settlement	04/12/2015 11:00	-22	Default Alert	Default Alert	
C435-LP13225	PLP	Settlement	04/12/2015 11:00	-23.3	Default Alert	Default Alert	
C435-LP13226	PLP	Settlement	04/12/2015 11:00	-25	Default Alert	Default Alert	
C435-LP13227	PLP	Settlement	04/12/2015 11:00	-25.1	Default Alert	Default Alert	
C435-LP13228	PLP	Settlement	04/12/2015 11:00	-24.2	Default Alert	Default Alert	

Table-5 Triggers breached by the Studs.

C.3 Significant Issues with the Instrumentation

No issues with these devices.

C.4 Residual Risks

As per C435-PMI-00549 the Long Term Monitoring has been ceased by Contract C435 in this area. The last measurement carried out by C435 for these instruments was undertaken on 04-12-2015. Long term monitoring will be continued by Crossrail to review long term stability.

D. CONCLUSIONS

No triggers breached, monitoring stable. No residual risks remain. Long term monitoring to be completed by InSar/Crossrail.

APPENDIX A: DRAWINGS

Learning Legacy Document

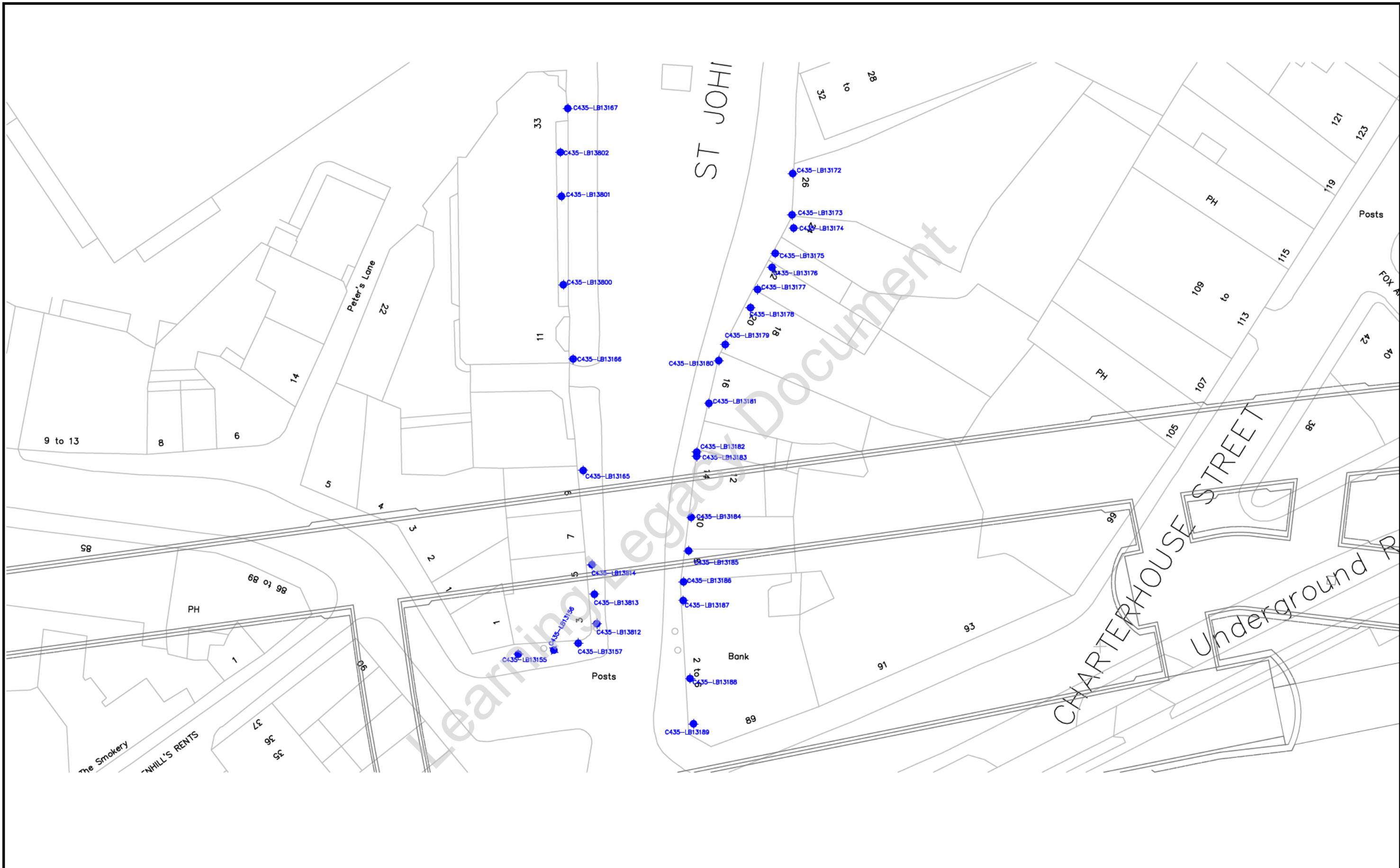

Rev.	Date	Description	By	Chkd	App	Auth

Notes:





 C/ Los Llanos de Jerez 10-12
 28823- MADRID
 www.geocisa.com

Contract : BORED TUNNELS (ALIGNMENT AND TRACK)		By	[Redacted]
Originator : OVE ARUP & PARTNERS LIMITED		Ch	
Location : CROSSRAIL GENERAL		Ap	
Title : C435-INSTRUMENTATION AND MONITORING-PRECISE LEVELLING GROUND SOCKETS		Auth :	
Drg No :	C435-BFK-C2-DWG-M123-50043	Rev :	Sult :

\$P.bys\$

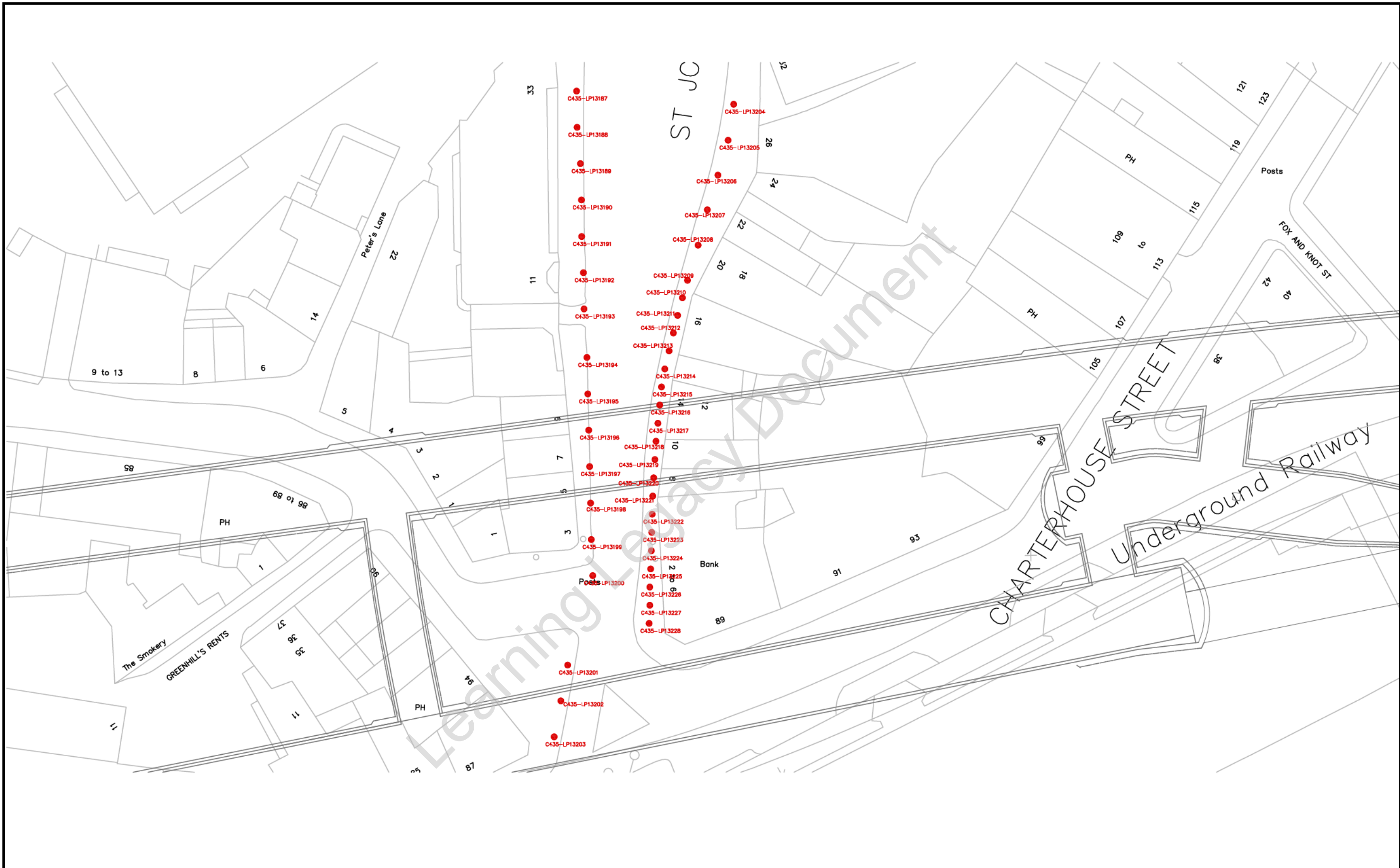

Rev.	Date	Description	By	Chkd	App	Auth

Notes:





C/ Los Llanos de Jerez 10-12
28823- MADRID
www.geocisa.com

Contract : BORED TUNNELS (ALIGNMENT AND TRACK)		By :	[REDACTED]
Originator : OVE ARUP & PARTNERS LIMITED		Chk :	
Location : CROSSRAIL GENERAL		App :	
Title : C435-INSTRUMENTATION AND MONITORING-PRECISE LEVELLING GROUND STUDS		Auth :	
Drg No : C435-BFK-C2-DWG-M123-50044	Rev :	Sult :	Auth : 

\$Pby\$

APPENDIX B: GRAPHS

Learning Legacy Document



REPORT LEVELLING
AREA 3-5 ST JOHN STREET
DEVICE Precise Levelling Points

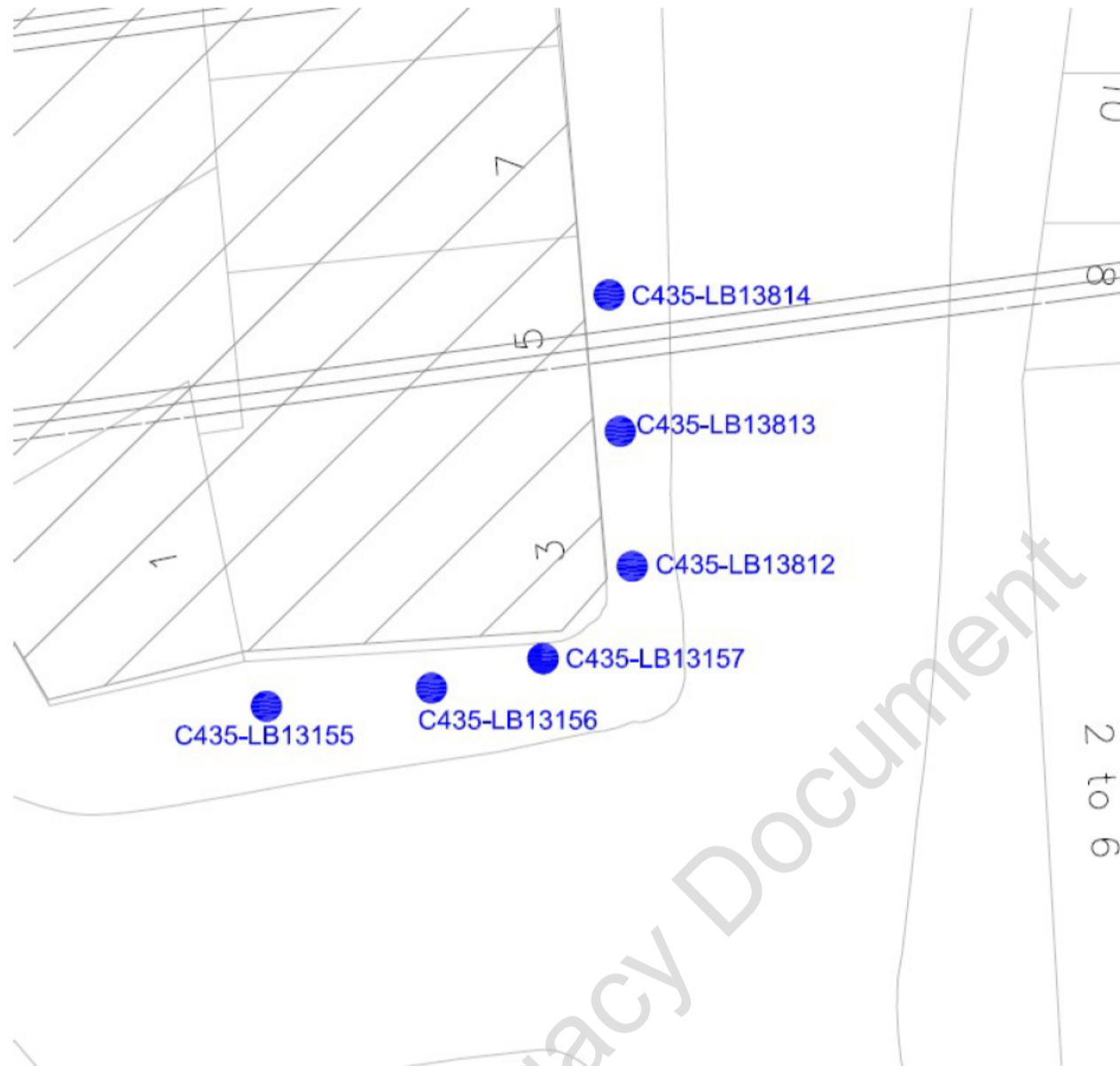

Building: 3-5 ST JOHN STREET

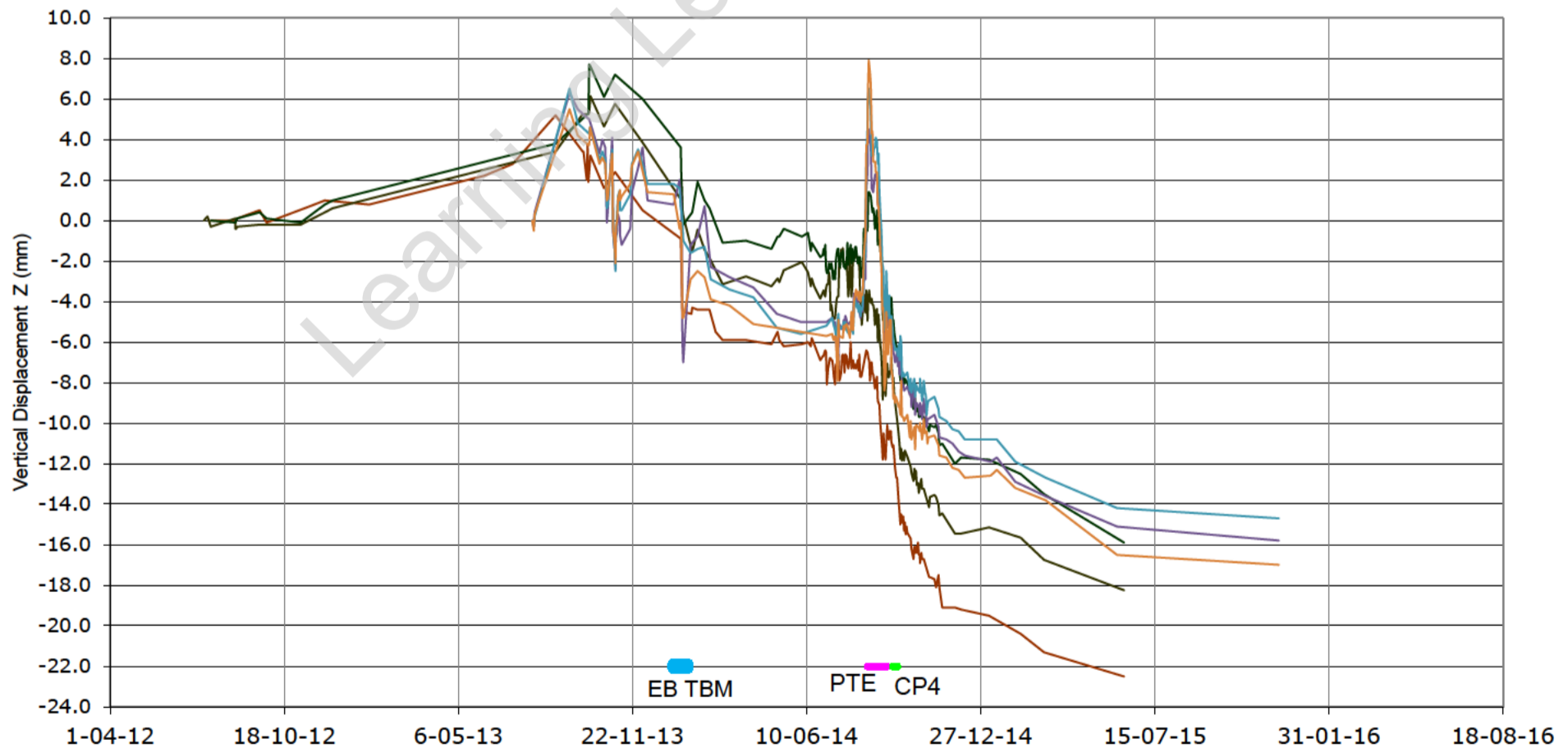

— C435-LB13155 — C435-LB13156 — C435-LB13157 — C435-LB13812 — C435-LB13813 — C435-LB13814

REMARKS:



GEOCISA UK

REPORT LEVELLING
AREA 7-9 ST JOHN STREET
DEVICE Precise Levelling Points

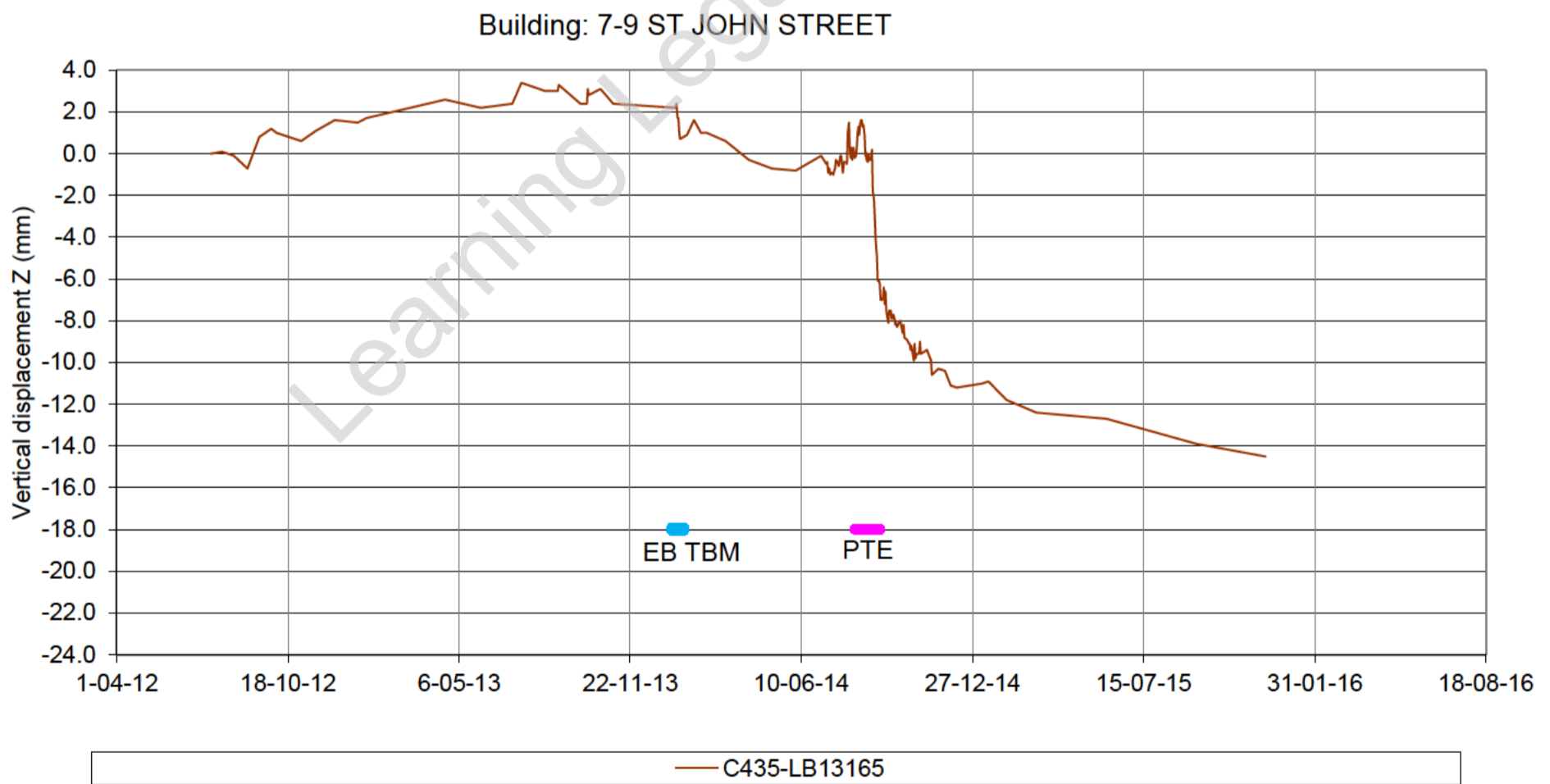
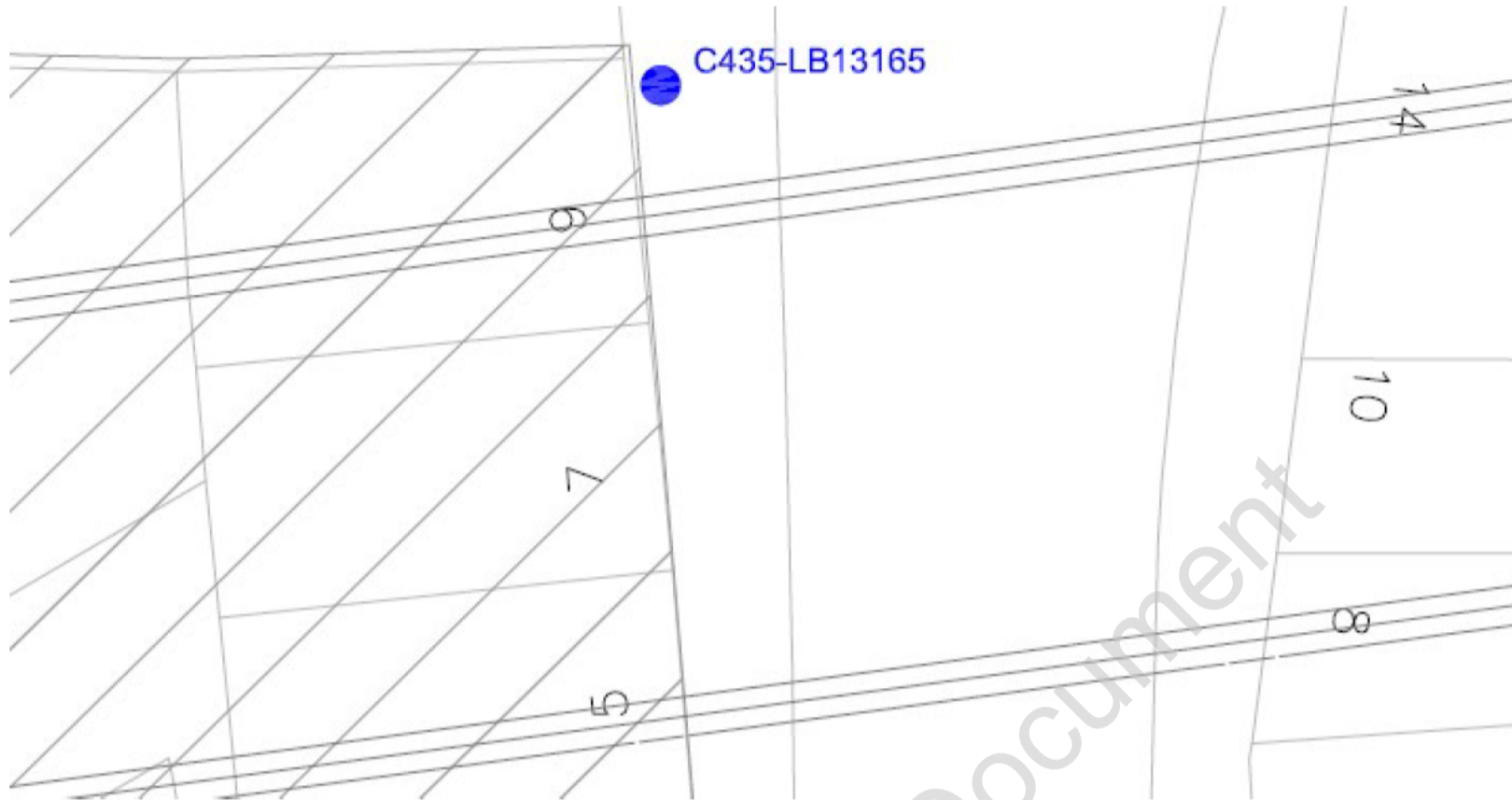

REMARKS:

REPORT LEVELLING
 AREA 11-33 ST JOHN STREET
 DEVICE Precise Levelling Points

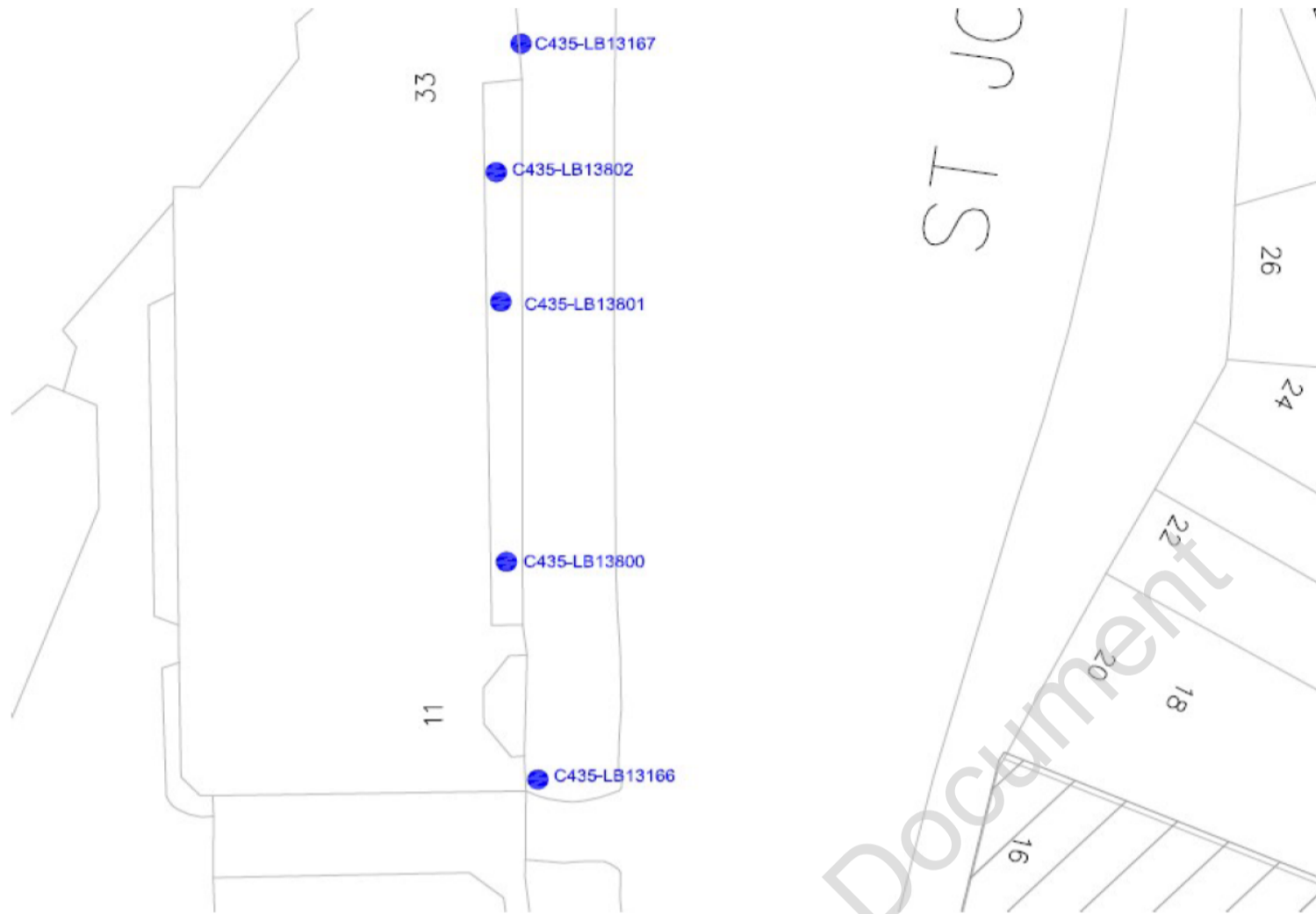

Building: 11-33 ST JOHN STREET

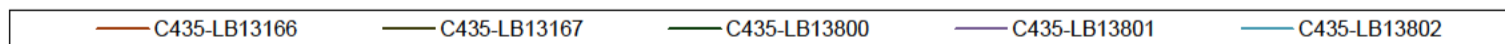
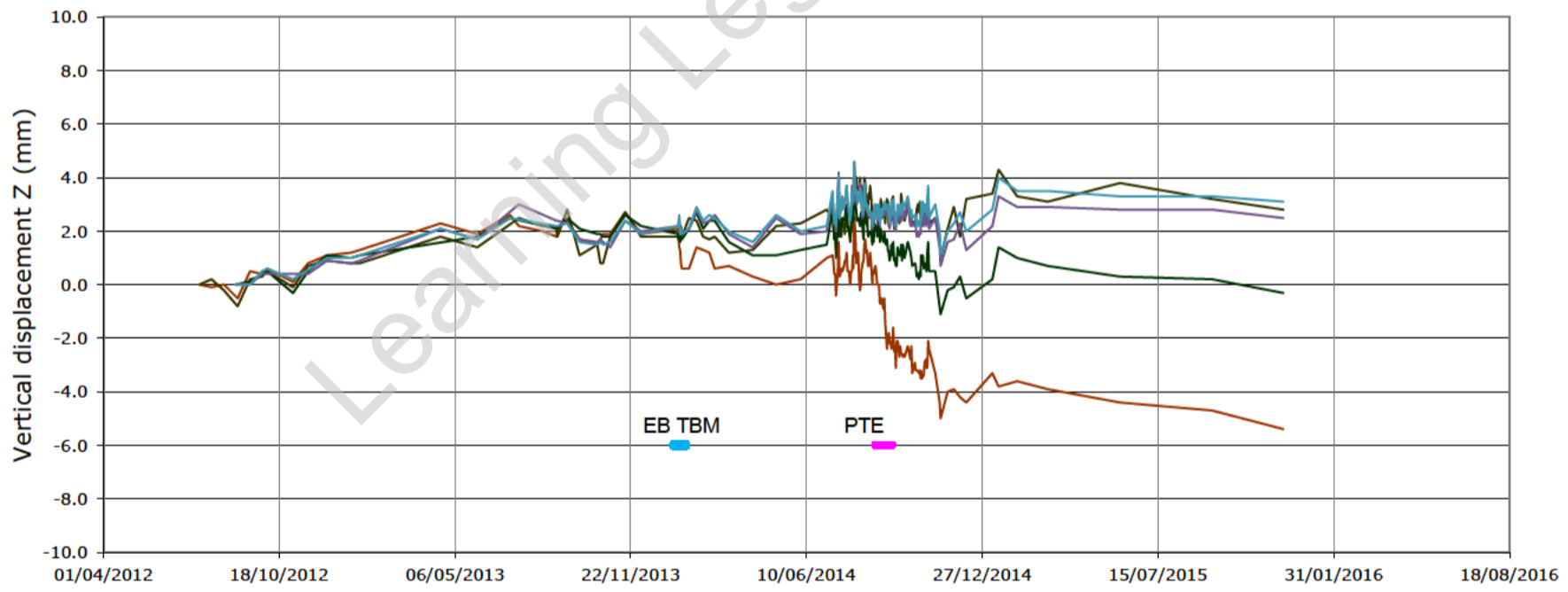

REMARKS:



REPORT LEVELLING
AREA 2-6 ST JOHN STREET
DEVICE Precise Levelling Points

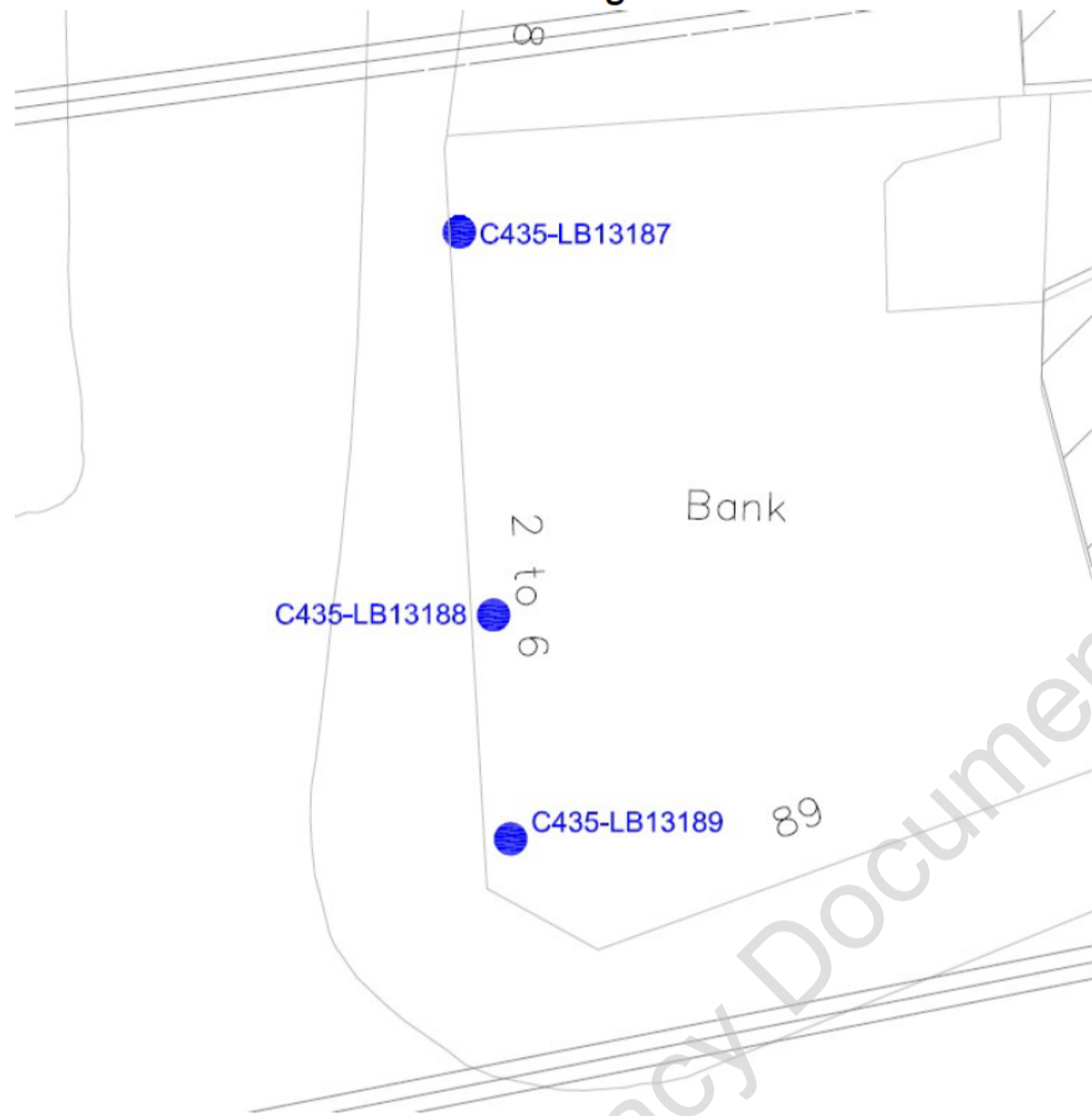

Building: 2-6 ST JOHN STREET

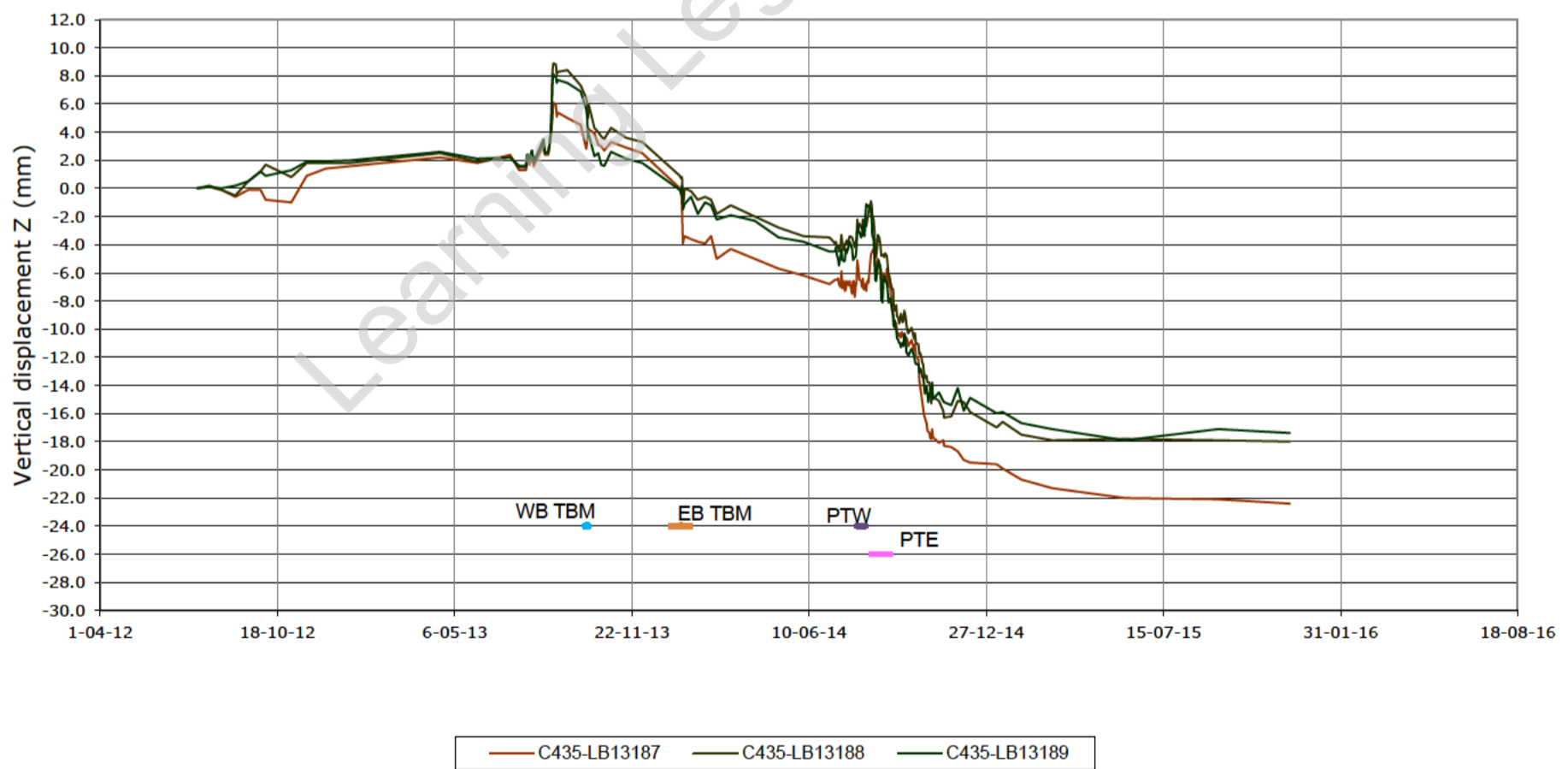

REMARKS:



REPORT LEVELLING
AREA 8-12 ST JOHN STREET
DEVICE Precise Levelling Points

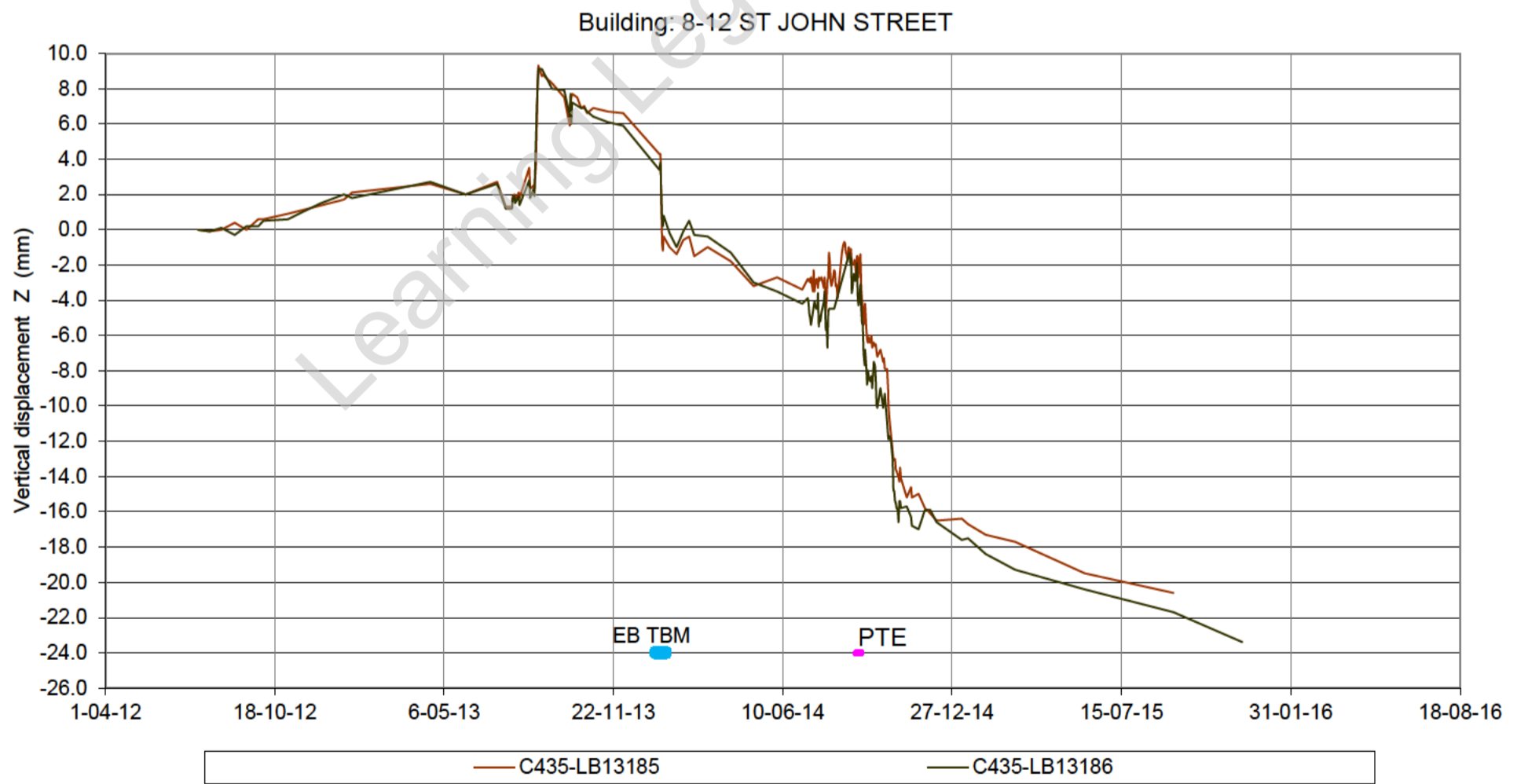
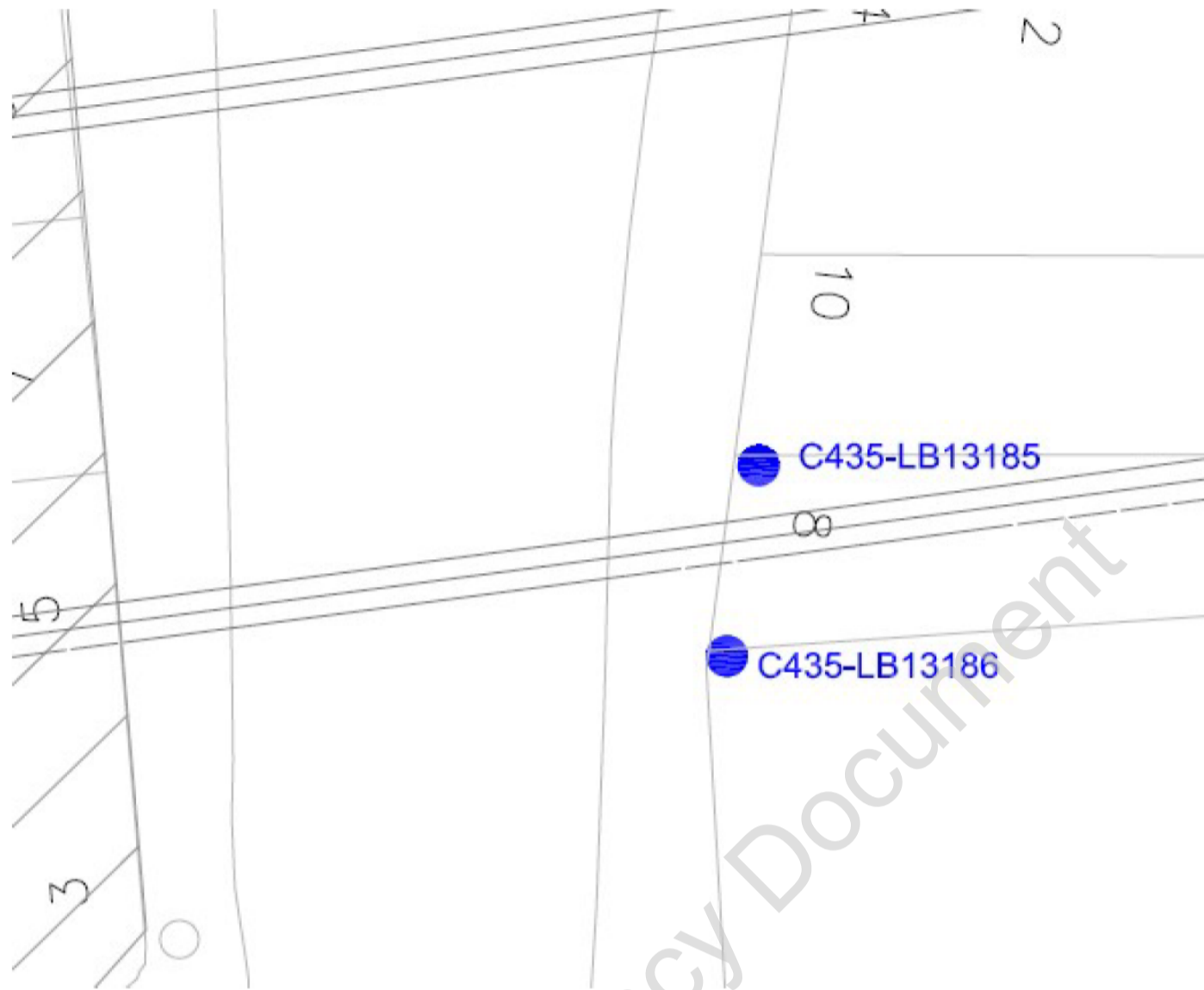

REMARKS:



REPORT LEVELLING
AREA 12-14 ST JOHN STREET
DEVICE Precise Levelling Points

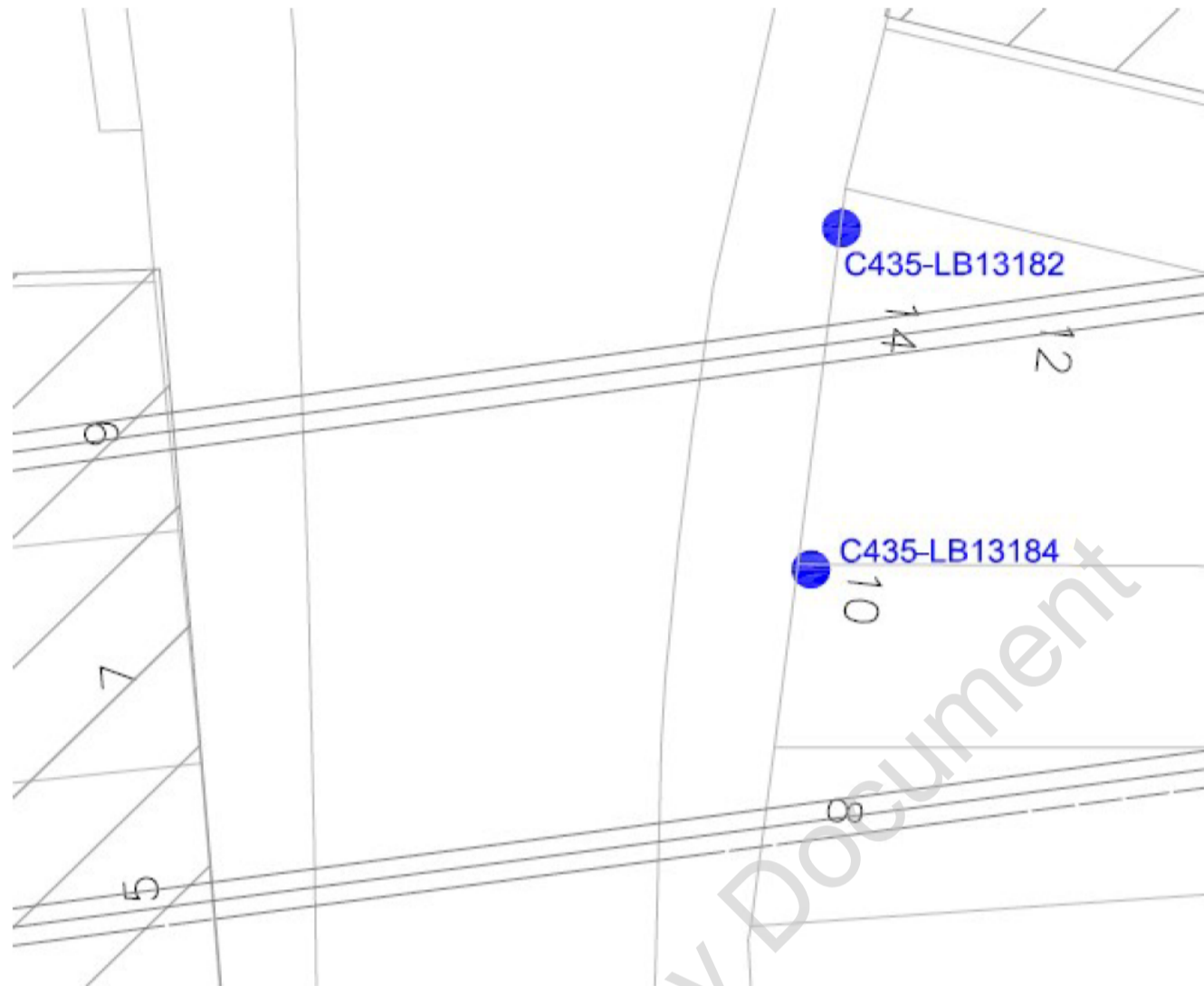

Building: 12-14 ST JOHN STREET

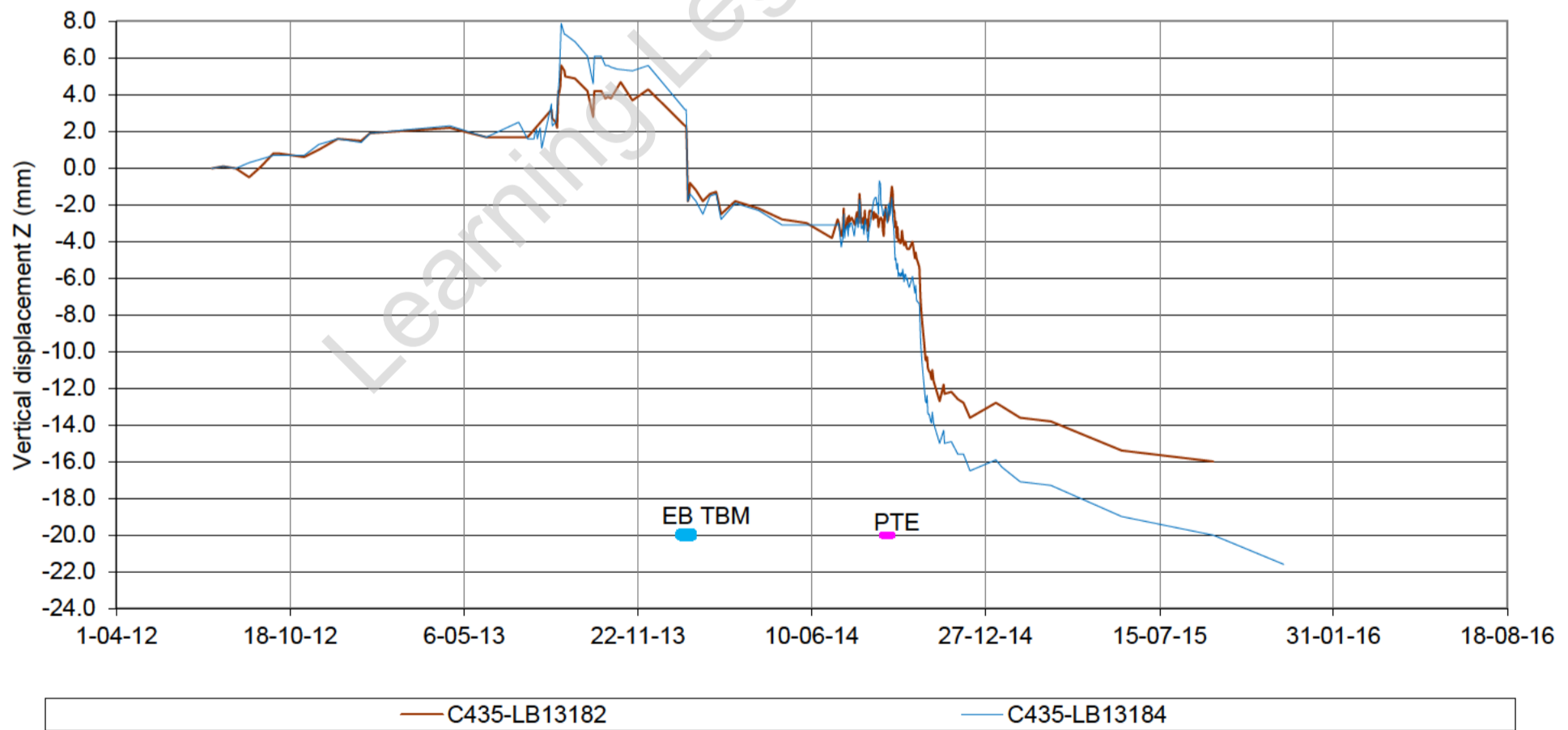

REMARKS:



GEOCISA UK

REPORT LEVELLING
AREA 16 St John St
DEVICE Precise Levelling Points

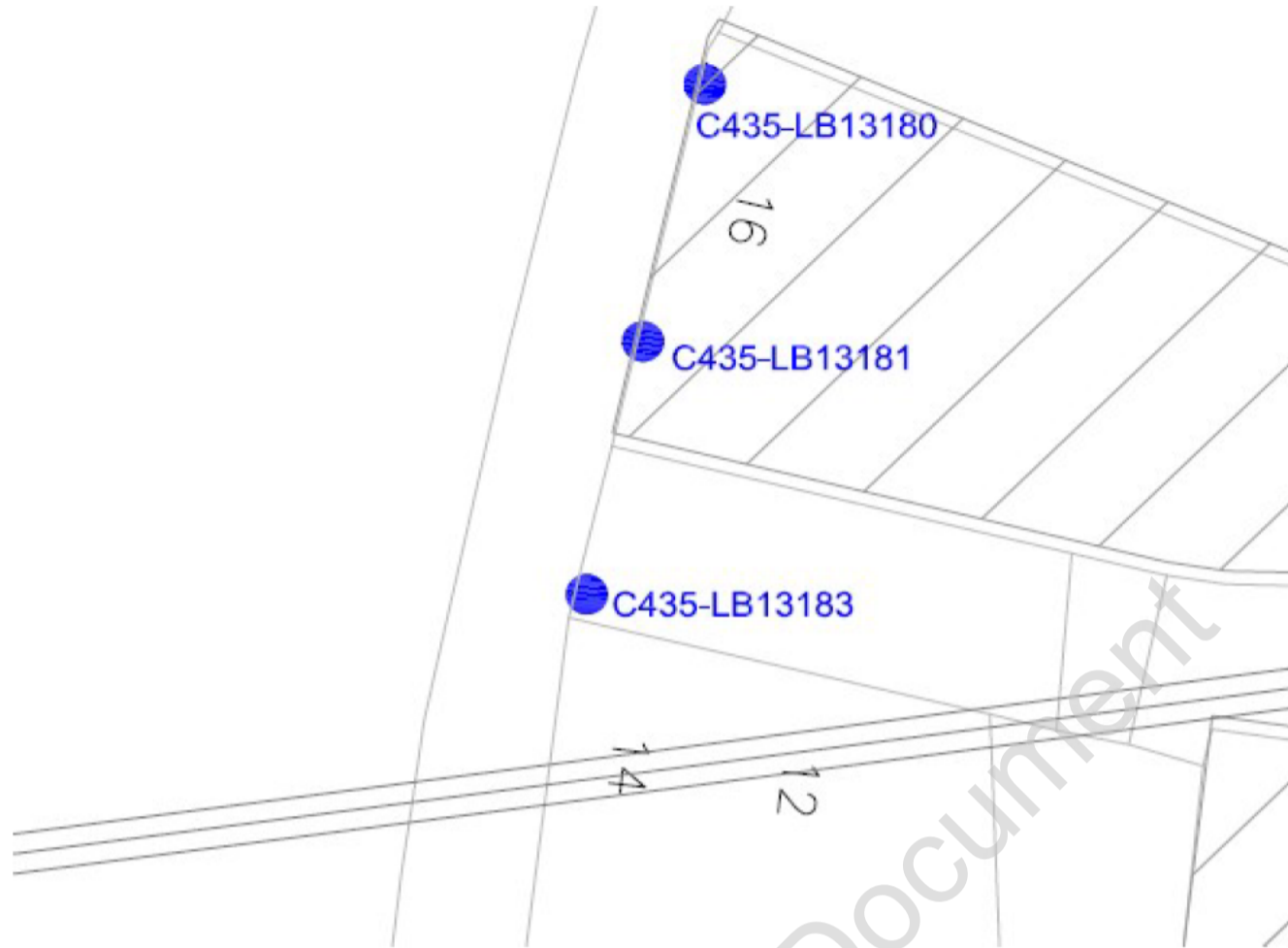

Building: 16 St John St

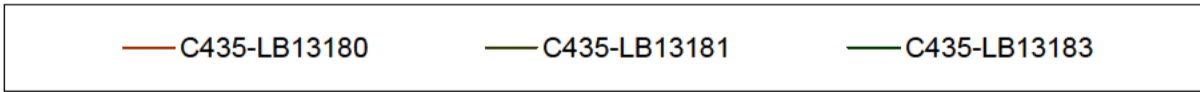
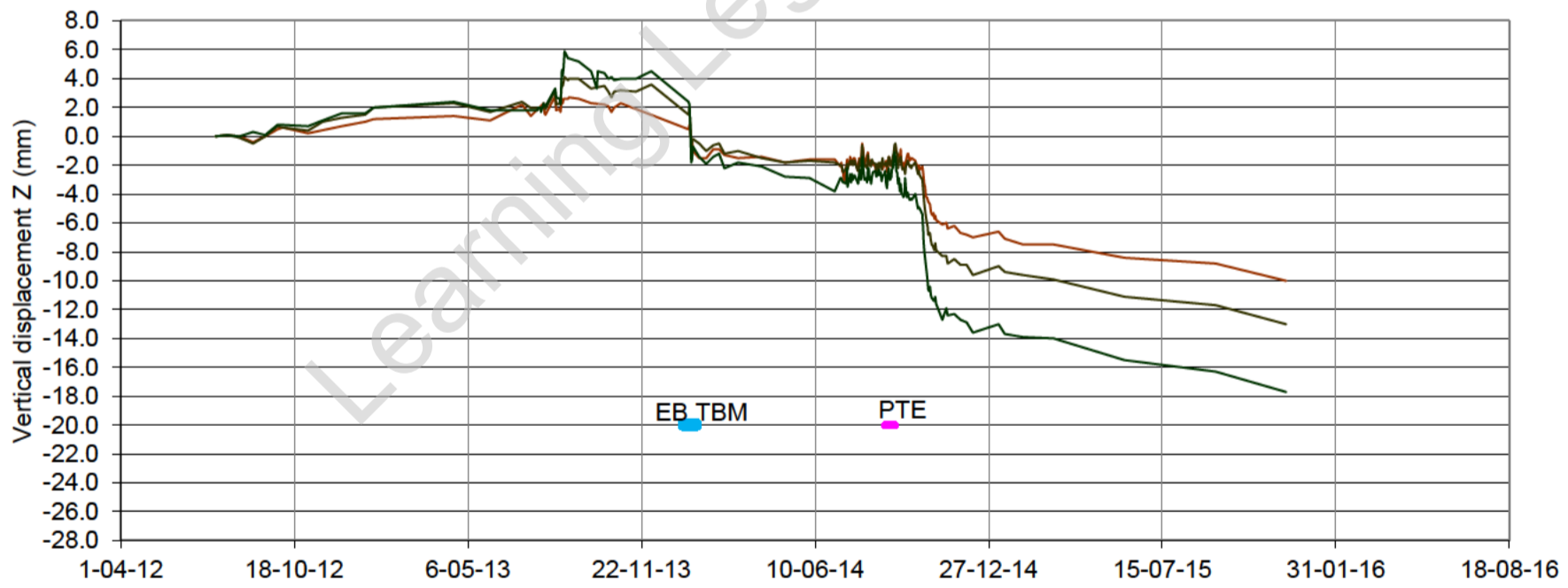

REMARKS:



GEOCISA UK

REPORT
AREA
DEVICE

LEVELLING
20-26 St John St
Precise Levelling Points



Building: 20-26 St John St

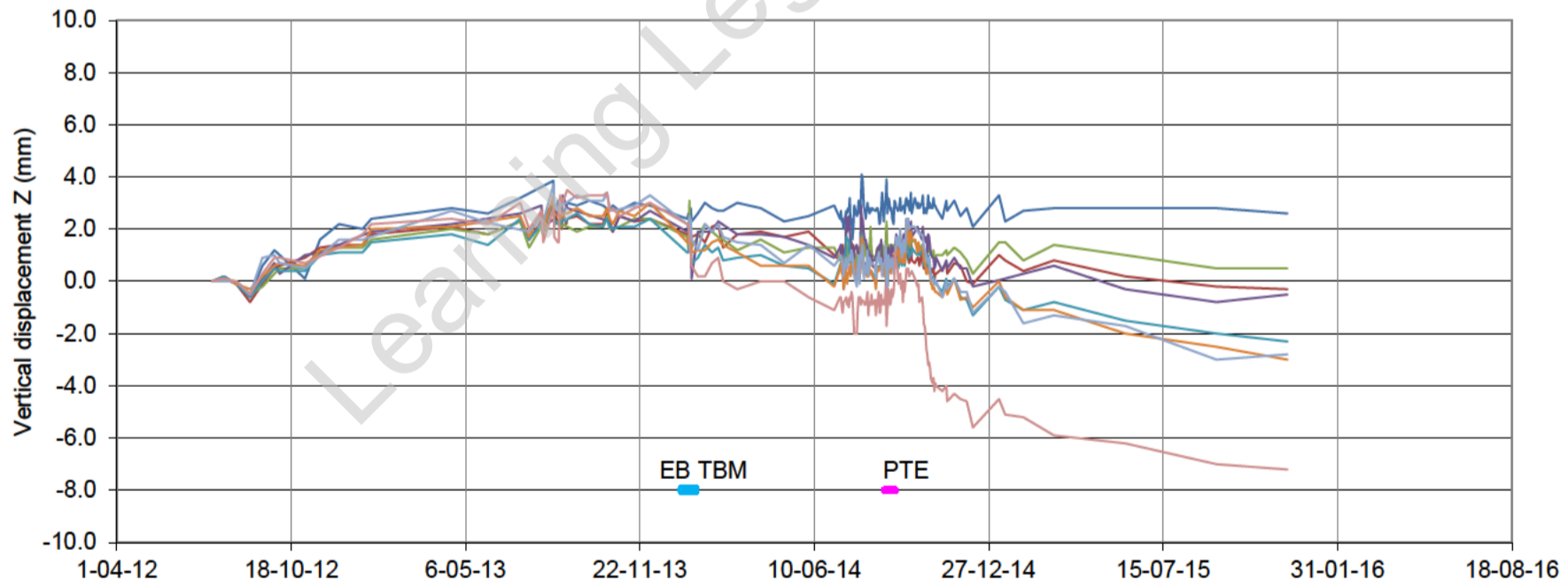

— C435-LB13172	— C435-LB13173	— C435-LB13174	— C435-LB13175
— C435-LB13176	— C435-LB13177	— C435-LB13178	— C435-LB13179

REMARKS:



REPORT: LEVELLING
AREA: St John St
DEVICE: PLP'S

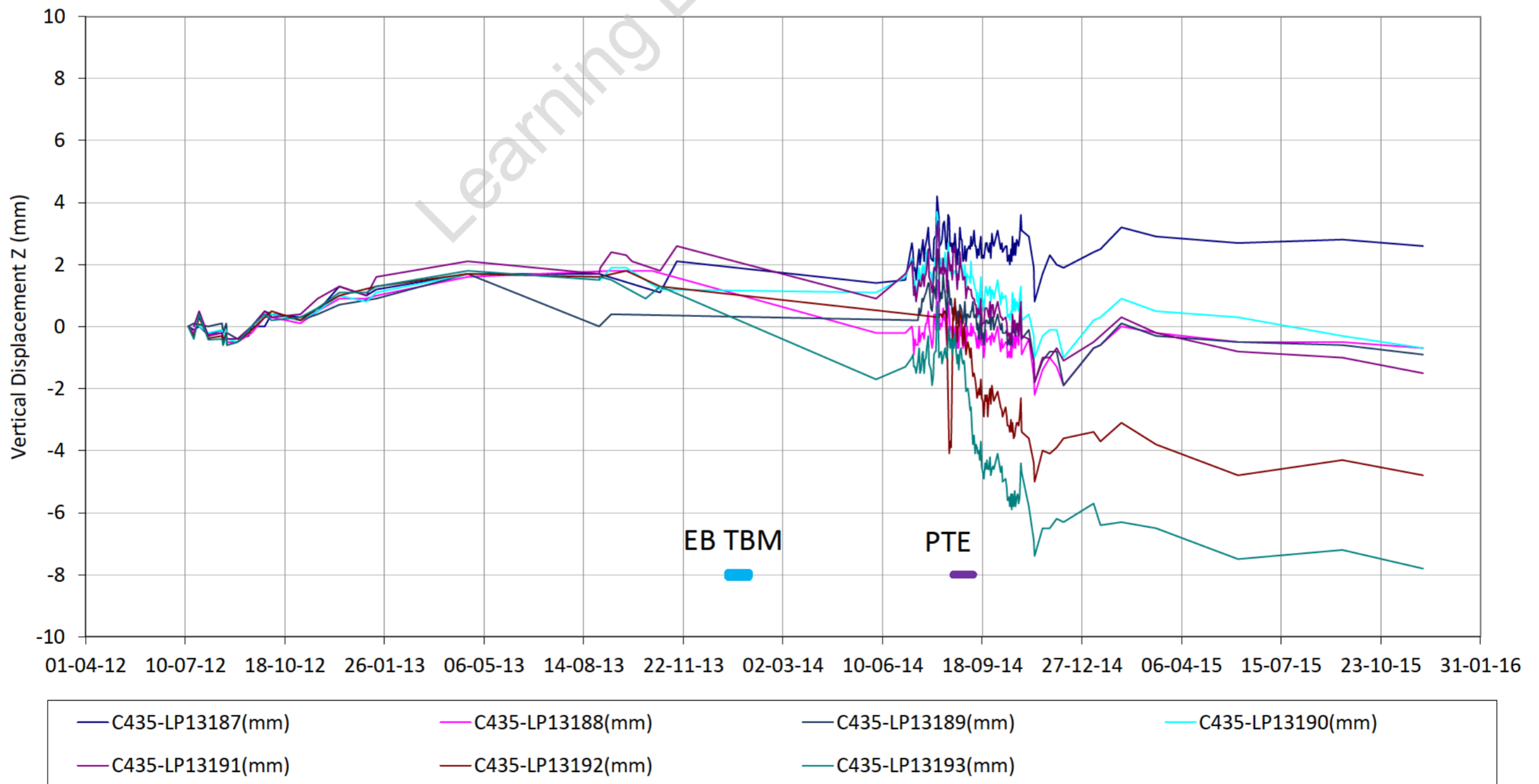

REMARKS:

Empty box for remarks.



REPORT: LEVELLING
AREA: St John St
DEVICE: PLP'S

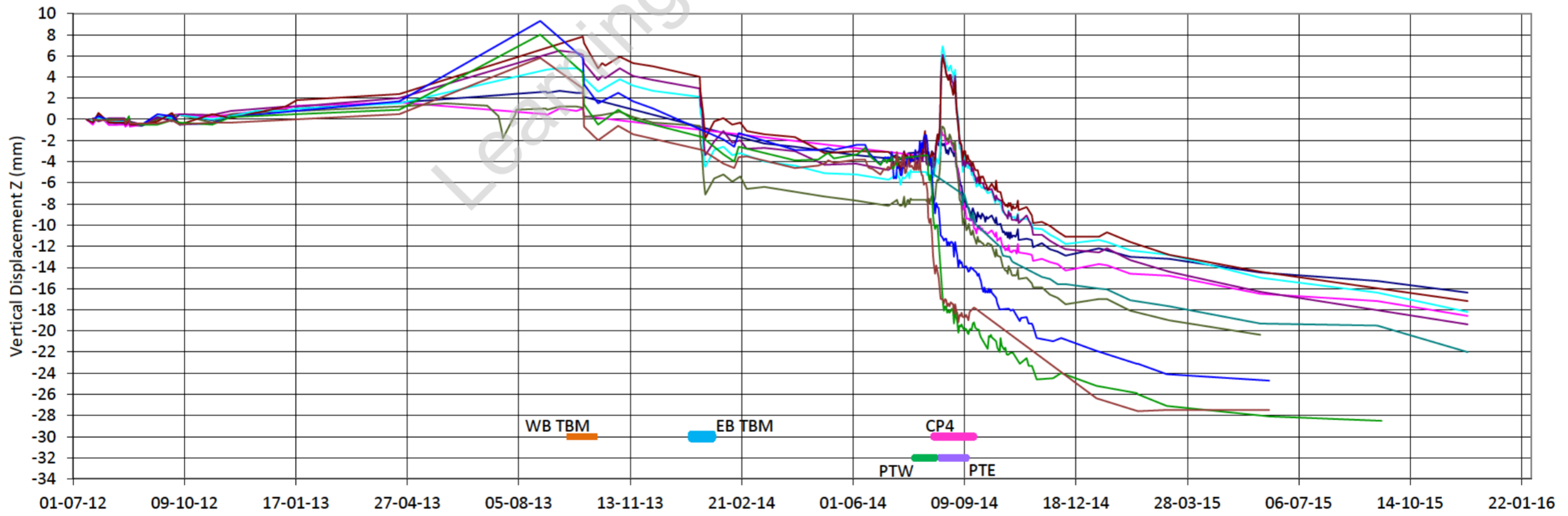

C435-LP13194(mm)	C435-LP13195(mm)	C435-LP13196(mm)	C435-LP13197(mm)	C435-LP13198(mm)
C435-LP13199(mm)	C435-LP13200(mm)	C435-LP13201(mm)	C435-LP13202(mm)	C435-LP13203(mm)

REMARKS:

REMARKS:



REPORT: LEVELLING
AREA: St John St
DEVICE: PLP'S

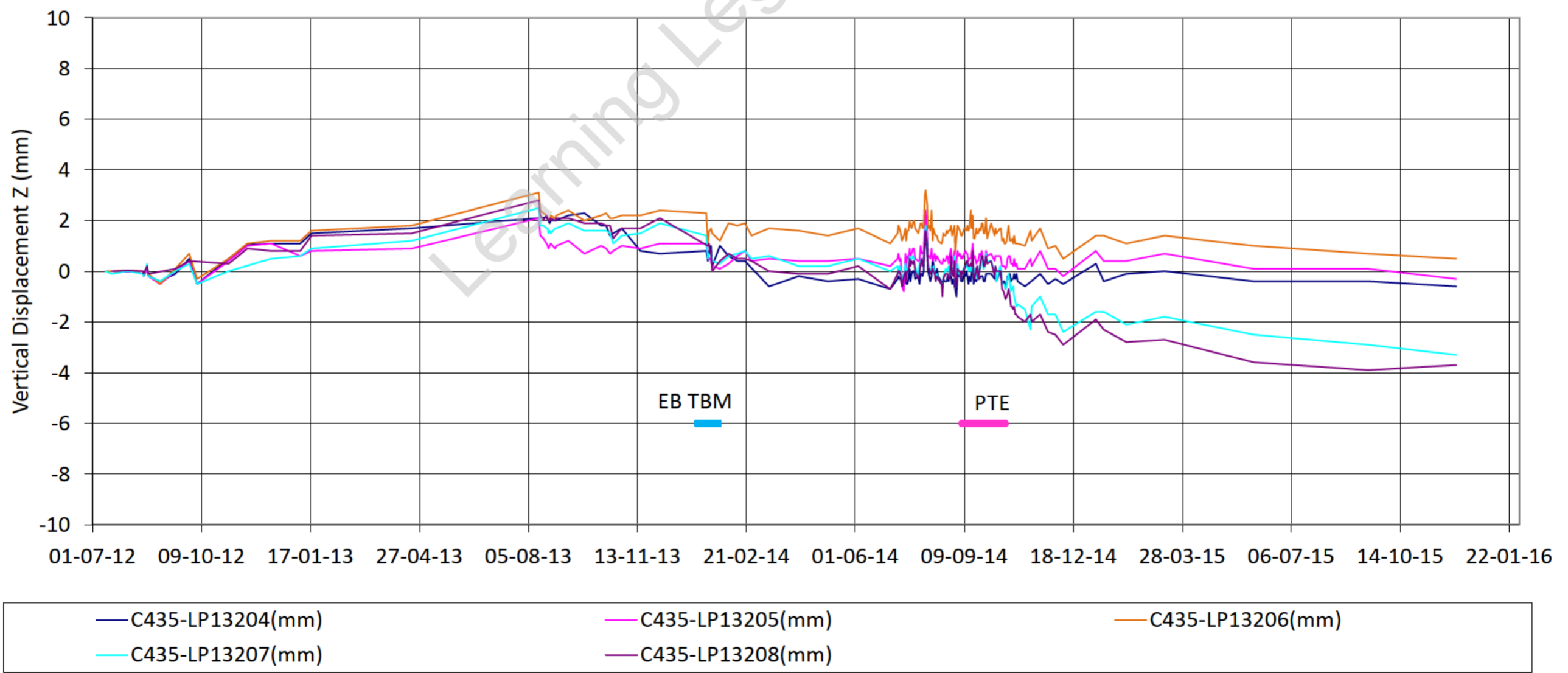

REMARKS:

Empty rectangular box for remarks.



REPORT: LEVELLING
AREA: St John St
DEVICE: PLP'S

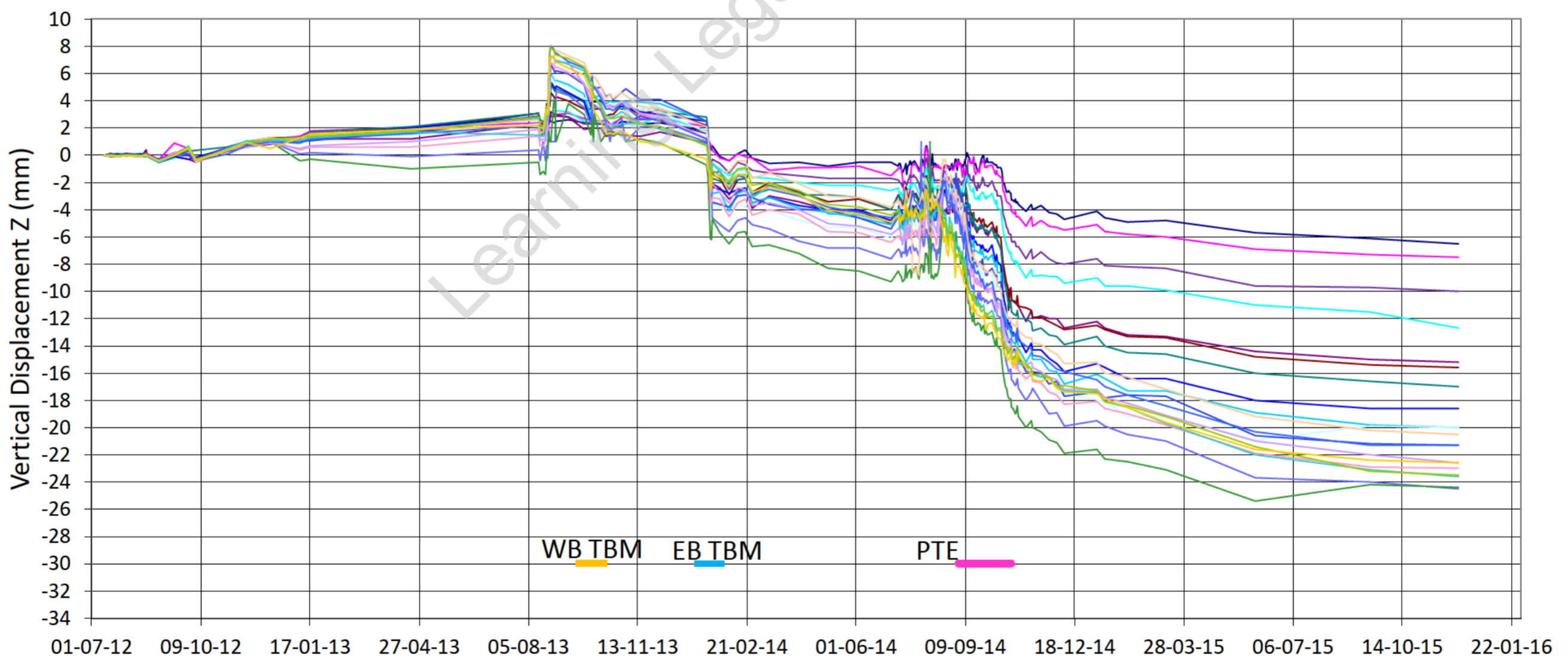
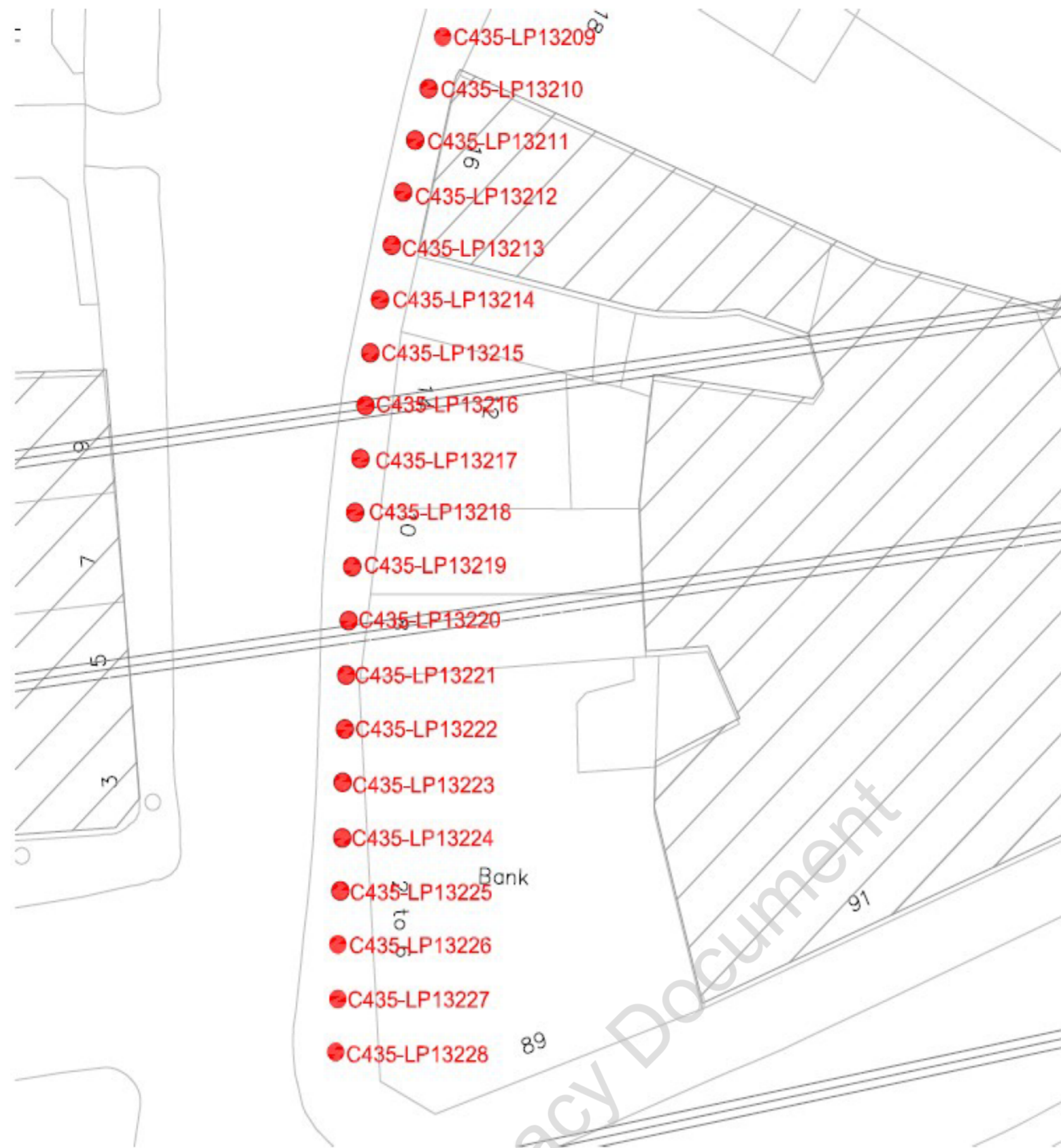

— C435-LP13209(mm)	— C435-LP13210(mm)	— C435-LP13211(mm)	— C435-LP13212(mm)
— C435-LP13213(mm)	— C435-LP13214(mm)	— C435-LP13215(mm)	— C435-LP13216(mm)
— C435-LP13217(mm)	— C435-LP13218(mm)	— C435-LP13219(mm)	— C435-LP13220(mm)
— C435-LP13221(mm)	— C435-LP13222(mm)	— C435-LP13223(mm)	— C435-LP13224(mm)
— C435-LP13225(mm)	— C435-LP13226(mm)	— C435-LP13227(mm)	— C435-LP13228(mm)

APPENDIX C: GLOSSARY

- ATS Automatic Total Station.
- ETH Eastern Ticket Hall.
- WB Westbound.
- TBM Tunnel Boring Machine.
- EB Eastbound.
- PTW Platform Tunnel West.
- PTE Platform Tunnel East.
- CP Cross Passages.
- CH Concourse Hall.
- VA Ventilation Adit.
- STE Stub Tunnel East.
- RTE Running Tunnel East.
- ES Escalator Shaft.
- TaM Tube a Manchette.

Learning Legacy Document